

CHIP COIL (CHIP INDUCTORS) LQW18AN□□□□0ZD
Murata Standard Reference Specification 【AEC-Q200】

1.Scope

This reference specification applies to LQW18AN_0ZD series, Chip coil(Chip Inductors) for automotive Electronics based on AEC-Q200 except for Power train and Safety.

2.Part Numbering

(ex)	LQ	W	18	A	N	2N2	D	0	Z	D
	Product ID	Structure	Dimension (L×W)	Applications and Characteristics	Category	Inductance	Tolerance	Features	Application Z:Automotive	Packaging D:Taping

3.Rating

- Operating Temperature Range. -55°C to +125°C
- Storage Temperature Range. -55°C to +125°C

Customer Part Number	MURATA Part Number	Inductance(*1) (Refer to below Comment)		Q (*1) (min.)	DC Resistance (*1) (Ω max.)	Self Resonant Frequency (*1) (MHz min.)	Rated Current (mA)	ESD Rank 6: 25kV			
		(nH)	Tolerance								
	LQW18AN2N2D0ZD	2.2	D:±0.5nH	16	0.042	6000	700	6			
	LQW18AN3N6C0ZD	3.6	C:±0.2nH D:±0.5nH	25	0.059		850				
	LQW18AN3N6D0ZD										
	LQW18AN3N9C0ZD	3.9	C:±0.2nH D:±0.5nH	35	0.082		750				
	LQW18AN3N9D0ZD										
	LQW18AN4N3C0ZD	4.3	C:±0.2nH D:±0.5nH								
	LQW18AN4N3D0ZD										
	LQW18AN4N7D0ZD	4.7	D:±0.5nH								
	LQW18AN5N6C0ZD	5.6	C:±0.2nH D:±0.5nH						0.11	650	
	LQW18AN5N6D0ZD										
	LQW18AN6N2C0ZD	6.2									
	LQW18AN6N2D0ZD										
	LQW18AN6N8C0ZD	6.8									
	LQW18AN6N8D0ZD										
	LQW18AN7N5C0ZD	7.5									
	LQW18AN7N5D0ZD										
	LQW18AN8N2C0ZD	8.2									
	LQW18AN8N2D0ZD										
	LQW18AN8N7C0ZD	8.7									
	LQW18AN8N7D0ZD										
	LQW18AN9N1C0ZD	9.1									
	LQW18AN9N1D0ZD										
	LQW18AN9N5D0ZD	9.5									
	LQW18AN10NG0ZD	10									G:±2% J:±5%
	LQW18AN10NJ0ZD										
	LQW18AN11NG0ZD	11									
	LQW18AN11NJ0ZD										
	LQW18AN12NG0ZD	12									
	LQW18AN12NJ0ZD										
	LQW18AN13NG0ZD	13									
	LQW18AN13NJ0ZD										
	LQW18AN15NG0ZD	15									
	LQW18AN15NJ0ZD										
	LQW18AN16NG0ZD	16									
	LQW18AN16NJ0ZD										
	LQW18AN18NG0ZD	18									
	LQW18AN18NJ0ZD										
	LQW18AN20NG0ZD	20									
	LQW18AN20NJ0ZD										
	LQW18AN22NG0ZD	22									
	LQW18AN22NJ0ZD										

Reference Only

SpecNo.JELF243A-9116-01

P.2/10

Customer Part Number	MURATA Part Number	Inductance(*1) (Refer to below Comment)		Q (*1) (min.)	DC Resistance (*1) (Ω max.)	Self Resonant Frequency (*1) (MHz min.)	Rated Current (mA)	ESD Rank 6: 25kV	
		(nH)	Tolerance						
	LQW18AN24NG0ZD LQW18AN24NJ0ZD	24	G:±2% J:±5%	40	0.21	3800	500	6	
	LQW18AN27NG0ZD LQW18AN27NJ0ZD	27				3700	440		
	LQW18AN30NG0ZD LQW18AN30NJ0ZD	30			0.23	3300	420		
	LQW18AN33NG0ZD LQW18AN33NJ0ZD	33				3200			
	LQW18AN36NG0ZD LQW18AN36NJ0ZD	36			0.26	2900	400		
	LQW18AN39NG0ZD LQW18AN39NJ0ZD	39			0.26	2800	400		
	LQW18AN43NG0ZD LQW18AN43NJ0ZD	43			0.29	2700	380		
	LQW18AN47NG0ZD LQW18AN47NJ0ZD	47				2600			
	LQW18AN51NG0ZD LQW18AN51NJ0ZD	51			38	0.33	2500		370
	LQW18AN56NG0ZD LQW18AN56NJ0ZD	56				0.35	2400		360
	LQW18AN62NG0ZD LQW18AN62NJ0ZD	62		0.51		2300	280		
	LQW18AN68NG0ZD LQW18AN68NJ0ZD	68		0.38		2200	340		
	LQW18AN72NG0ZD LQW18AN72NJ0ZD	72		0.56		2100	270		
	LQW18AN75NG0ZD LQW18AN75NJ0ZD	75				2050			
	LQW18AN82NG0ZD LQW18AN82NJ0ZD	82		34	0.60	2000	250		
	LQW18AN91NG0ZD LQW18AN91NJ0ZD	91			0.64	1900	230		
	LQW18ANR10G0ZD LQW18ANR10J0ZD	100			0.68	1800	220		
	LQW18ANR11G0ZD LQW18ANR11J0ZD	110			1.2	1700	200		
	LQW18ANR12G0ZD LQW18ANR12J0ZD	120		32	1.3	1600	180		
	LQW18ANR13G0ZD LQW18ANR13J0ZD	130			1.4	1450	170		
	LQW18ANR15G0ZD LQW18ANR15J0ZD	150			1.5	1400	160		
	LQW18ANR16G0ZD LQW18ANR16J0ZD	160			2.1	1350	150		
	LQW18ANR18G0ZD LQW18ANR18J0ZD	180		25	2.2	1300	140		
	LQW18ANR20G0ZD LQW18ANR20J0ZD	200			2.4	1250	120		
	LQW18ANR22G0ZD LQW18ANR22J0ZD	220			2.5	1200			
	LQW18ANR27G0ZD LQW18ANR27J0ZD	270		30	3.4	960	110		
	LQW18ANR33G0ZD LQW18ANR33J0ZD	330			5.5	800	85		
	LQW18ANR39G0ZD LQW18ANR39J0ZD	390			6.2		80		
	LQW18ANR47G0ZD LQW18ANR47J0ZD	470			7.0	700	75		

(*1)

Standard Testing Conditions

《Unless otherwise specified》

Temperature : Ordinary Temperature / 15°C to 35°C
 Humidity : Ordinary Humidity / 25%(RH) to 85%(RH)

《In case of doubt》

Temperature : 20°C±2°C
 Humidity : 60%(RH) to 70%(RH)
 Atmospheric Pressure : 86kPa to 106 kPa

4. Appearance and Dimensions

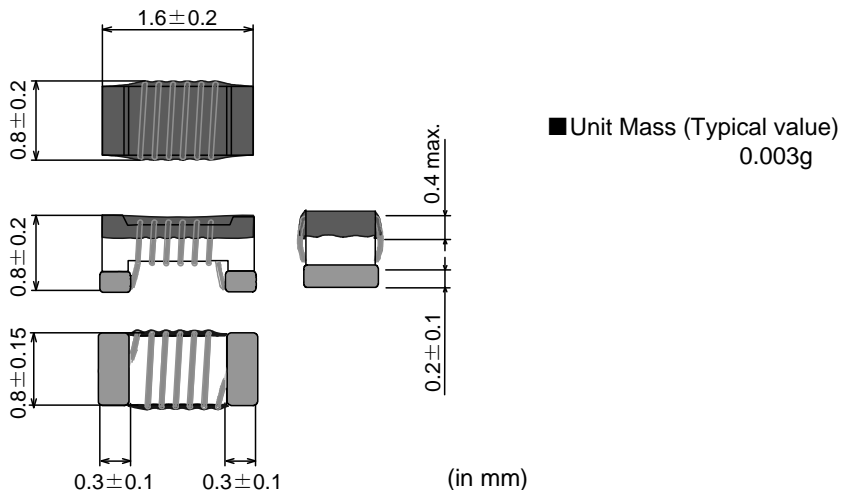

5. Electrical Performance

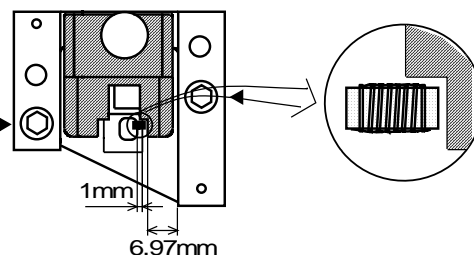
No.	Item	Specification	Test Method
5.1	Inductance	Inductance shall meet item 3.	Measuring Equipment: Agilent 4991A or equivalent Measuring Frequency: <Inductance> 100MHz <Q> 250MHz/ 2.2nH~39nH 200MHz/ 43nH~68nH 150MHz/ 72nH~160nH 100MHz/ 180nH~470nH Measuring Condition: Test signal level / about 0dBm Electrical length / 0.94cm Measuring Fixture: Agilent 16193A
5.2	Q	Q shall meet item 3.	Position coil under test as shown in below and contact coil with each terminal by adding weight.  Measuring Method: See P.10 <Electrical Performance: Measuring Method of Inductance/Q>
5.3	DC Resistance	DC Resistance shall meet item 3.	Measuring Equipment: Digital multi meter
5.4	Self Resonant Frequency(S.R.F)	S.R.F shall meet item 3.	Measuring Equipment: Agilent 5230A or equivalent
5.5	Rated Current	Self temperature rise shall be limited to 20°C max. Inductance Change: within ±10%	The rated current is applied.

6.Q200 Requirement**6.1.Performance (based on Table 5 for Magnetics(Inductors / Transformer)
AEC-Q200 Rev.D issued June 1. 2010**

AEC-Q200			Murata Specification / Deviation					
No	Stress	Test Method						
3	High Temperature Exposure	1000hours at 125 deg C Set for 24hours at room temperature, then measured.	Meet Table A after testing. Table A	<table border="1"> <tr> <td>Appearance</td> <td>No damage</td> </tr> <tr> <td>Inductance (at 100MHz)</td> <td>Within $\pm 5\%$</td> </tr> </table>	Appearance	No damage	Inductance (at 100MHz)	Within $\pm 5\%$
Appearance	No damage							
Inductance (at 100MHz)	Within $\pm 5\%$							
4	Temperature Cycling	1000cycles -40 deg C to +125 deg C Set for 24hours at room temperature, then measured.	Meet Table A after testing.					
7	Biased Humidity	1000hours at 85 deg C, 85%RH unpowered..	Meet Table A after testing.					
8	Operational Life	Apply Rated Current 125 deg C 1000hours Set for 24hours at room temperature, then measured	Meet Table A after testing.					
9	External Visual	Visual inspection	No abnormalities					
10	Physical Dimension	Meet ITEM 4 (Style and Dimensions)	No defects					
12	Resistance to Solvents	Per MIL-STD-202 Method 215	Not Applicable					
13	Mechanical Shock	Per MIL-STD-202 Method 213 Condition C : 100g's(0.98N), 6ms, Half sine, 12.3ft/s	Meet Table A after testing.					
14	Vibration	5g's(0.049N) for 20 minutes 12cycles each of 3 orientations Test from 10-2000Hz.	Meet Table A after testing.					
15	Resistance to Soldering Heat	No-heating Solder temperature 260C+/-5 deg C Immersion time 10s	Pre-heating: 150C +/-10 deg C, 60s to 90s Meet Table A after testing.					
17	ESD	Per AEC-Q200-002	ESD Rank: Refer to Item 3. Rating. Meet Table A after testing.					
18	Solderbility	Per J-STD-002	Method b : Not Applicable 95% of the terminations is to be soldered. (Except exposed wire)					
19	Electrical Characterization	Measured : Inductance	No defects					

AEC-Q200			Murata Specification / Deviation				
No	Stress	Test Method					
20	Flammability	Per UL-94	Not Applicable				
21	Board Flex	Epoxy-PCB(1.6mm) Deflection 2mm(min) Holding time 60s	Meet Table B after testing. <table border="1" style="margin-left: 20px; border-collapse: collapse;"> <tr> <td style="padding: 2px;">Appearance</td> <td style="padding: 2px;">No damage</td> </tr> <tr> <td style="padding: 2px;">DC resistance change</td> <td style="padding: 2px;">Within $\pm 10\%$</td> </tr> </table>	Appearance	No damage	DC resistance change	Within $\pm 10\%$
Appearance	No damage						
DC resistance change	Within $\pm 10\%$						
22	Terminal Strength	Per AEC-Q200-006 A force of 17.7N for 60s	Murata Deviation Request: 10N/5s No defect				

7.Specification of Packaging

7.1 Appearance and Dimensions of paper tape (8mm-wide)

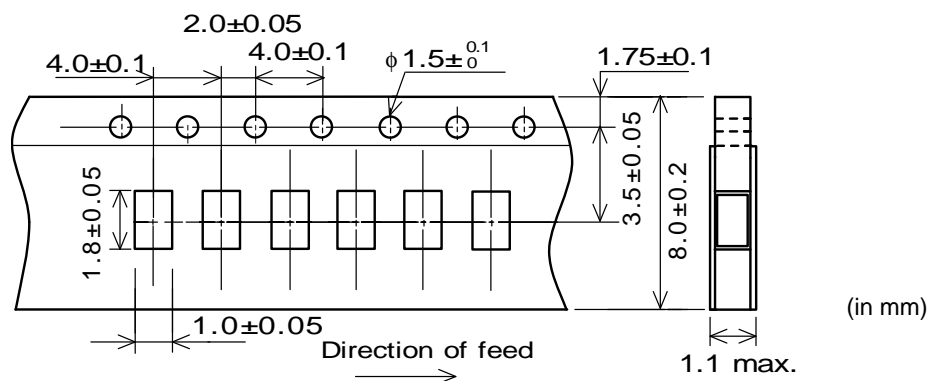

7.2 Specification of Taping

- (1) Packing quantity (standard quantity)
4,000 pcs. / reel
- (2) Packing Method
Products shall be packed in the cavity of the base tape and sealed by top tape and bottom tape.
- (3) Sprocket hole
The sprocket holes are to the right as the tape is pulled toward the user.
- (4) Spliced point
Base tape and Top tape has no spliced point.
- (5) Missing components number
Missing components number within 0.1 % of the number per reel or 1 pc., whichever is greater, and are not continuous. The Specified quantity per reel is kept.

7.3 Pull Strength

Top tape	5N min.
Bottom tape	

7.4 Peeling off force of cover tape

Speed of Peeling off	300mm/min
Peeling off force	0.1N to 0.6N (minimum value is typical)

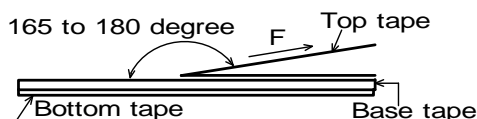

7.5 Dimensions of Leader-tape,Trailer and Reel

There shall be leader-tape (top tape and empty tape) and trailer-tape (empty tape) as follows.

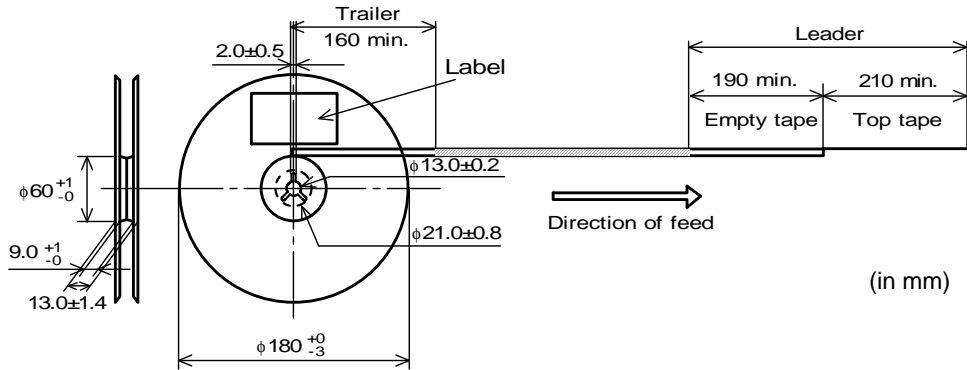

7.6 Marking for reel

Customer part number, MURATA part number, Inspection number(*1) ,RoHS Marking(*2), Quantity etc ...

*1) <Expression of Inspection No.>

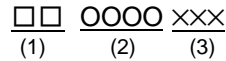

(1) Factory code

(2) Date First digit : Year / Last digit of year

Second digit : Month / Jan. → 1 to 9, Oct. to Dec. → O,N,D

Third, Fourth digit : Day

(3) Serial No.

*2) <Expression of RoHS Marking>

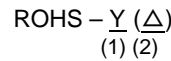

(1) RoHS regulation conformity parts.

(2) MURATA classification number

7.7 Marking for Outside package (corrugated paper box)

Customer name, Purchasing order number, Customer part number, MURATA part number, RoHS Marking(*2) ,Quantity, etc ...

7.8. Specification of Outer Case

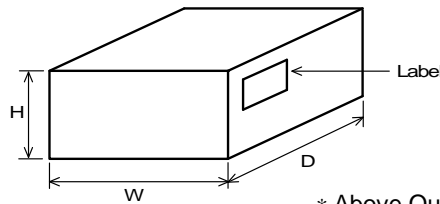

Outer Case Dimensions (mm)			Standard Reel Quantity in Outer Case (Reel)
W	D	H	
186	186	93	5

* Above Outer Case size is typical. It depends on a quantity of an order.

8. ⚠ Caution

8.1 Caution(Rating)

Do not exceed maximum rated current of the product. Thermal stress may be transmitted to the product and short/open circuit of the product or falling off the product may be occurred.

8.2 Fail-safe

Be sure to provide an appropriate fail-safe function on your product to prevent a second damage that may be caused by the abnormal function or the failure of our product.

8.3 Limitation of Applications

Please contact us before using our products for the applications listed below which require especially high reliability for the prevention of defects which might directly cause damage to the third party's life, body or property.

- | | |
|-----------------------------------|--|
| (1) Aircraft equipment | (6) Transportation equipment (trains, ships, etc.) |
| (2) Aerospace equipment | (7) Traffic signal equipment |
| (3) Undersea equipment | (8) Disaster prevention / crime prevention equipment |
| (4) Power plant control equipment | (9) Data-processing equipment |
| (5) Medical equipment | (10) Applications of similar complexity and /or reliability requirements to the applications listed in the above |

9. Notice

Products can only be soldered with reflow.
 This product is designed for solder mounting.
 Please consult us in advance for applying other mounting method such as conductive adhesive.

9.1 Land pattern designing

Recommended land patterns for reflow soldering are as follows:
 These have been designed for Electric characteristics and solderability.
 Please follow the recommended patterns. Otherwise, their performance which includes electrical performance or solderability may be affected, or result to "position shift" in soldering process.

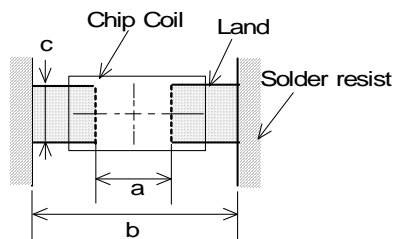

a	0.6 to 0.8
b	1.9 to 2.0
c	0.7 to 1.0

(in mm)

9.2 Flux, Solder

- Use rosin-based flux.
 Includes middle activator equivalent to 0.06(wt)% to 0.1(wt)% Chlorine.
 Don't use highly acidic flux with halide content exceeding 0.2(wt)% (chlorine conversion value).
 Don't use water-soluble flux.
- Use Sn-3.0Ag-0.5Cu solder.
- Standard thickness of solder paste : 100 μ m to 150 μ m.

9.3 Reflow soldering conditions

- Pre-heating should be in such a way that the temperature difference between solder and product surface is limited to 150°C max. Cooling into solvent after soldering also should be in such a way that the temperature difference is limited to 100°C max.
 Insufficient pre-heating may cause cracks on the product, resulting in the deterioration of products quality.
- Standard soldering profile and the limit soldering profile is as follows.
 The excessive limit soldering conditions may cause leaching of the electrode and / or resulting in the deterioration of product quality.

• Reflow soldering profile

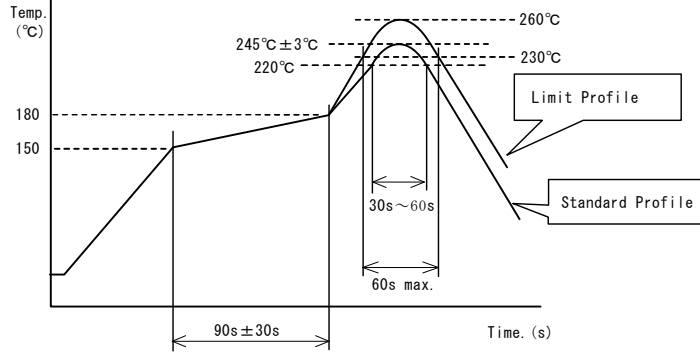

	Standard Profile	Limit Profile
Pre-heating	150°C~180°C , 90s±30s	
Heating	above 220°C, 30s~60s	above 230°C, 60s max.
Peak temperature	245°C±3°C	260°C,10s
Cycle of reflow	2 times	

9.4 Reworking with soldering iron

The following conditions must be strictly followed when using a soldering iron.

Pre-heating	150°C, 1 min
Tip temperature	350°C max.
Soldering iron output	80W max.
Tip diameter	φ 3mm max.
Soldering time	3(+1,-0)s
Time	2 times

Note :Do not directly touch the products with the tip of the soldering iron in order to prevent the crack on the products due to the thermal shock.

9.5 Solder Volume

- Solder shall be used not to be exceeded the upper limits as shown below.
- Accordingly increasing the solder volume, the mechanical stress to Chip is also increased. Exceeding solder volume may cause the failure of mechanical or electrical performance.

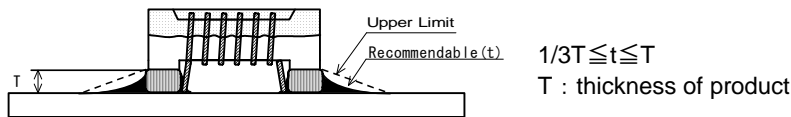

9.6 Product's location

The following shall be considered when designing and laying out P.C.B.'s.

- (1) P.C.B. shall be designed so that products are not subject to the mechanical stress due to warping the board.

[Products direction]

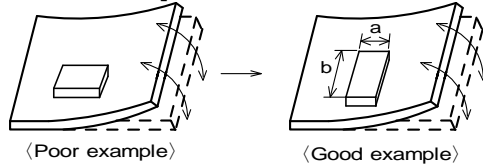

Products shall be located in the sideways direction (Length:a < b) to the mechanical stress.

- (2) Products location on P.C.B. separation

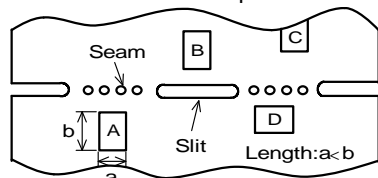

Products (A,B,C,D) shall be located carefully so that products are not subject to the mechanical stress due to warping the board. Because they may be subjected the mechanical stress in order of $A > C > B \cong D$.

9.7 Cleaning Conditions

Products shall be cleaned on the following conditions.

- (1) Cleaning temperature shall be limited to 60°C max.(40°C max for IPA)
- (2) Ultrasonic cleaning shall comply with the following conditions with avoiding the resonance phenomenon at the mounted products and P.C.B.
Power : 20 W / l max. Frequency : 28kHz to 40kHz Time : 5 min max.
- (3) Cleaner
 1. Alcohol type cleaner
Isopropyl alcohol (IPA)
 2. Aqueous agent
PINE ALPHA ST-100S
- (4) There shall be no residual flux and residual cleaner after cleaning.
In the case of using aqueous agent, products shall be dried completely after rinse with de-ionized water in order to remove the cleaner.
- (5) Other cleaning Please contact us.

9.8 Resin coating

The inductance value may change due to high cure-stress of resin to be used for coating/molding products. An open circuit issue may occur by mechanical stress caused by the resin, amount/cured shape of resin, or operating condition etc. Some resin contains some impurities or chloride possible to generate chlorine by hydrolysis under some operating condition may cause corrosion of wire of coil, leading to open circuit. So, please pay your careful attention when you select resin in case of coating/molding the products with the resin.

Prior to use the coating resin, please make sure no reliability issue is observed by evaluating products mounted on your board.

9.9 Caution for use

- Sharp material such as a pair of tweezers or other material such as bristles of cleaning brush , shall not be touched to the winding portion to prevent the breaking of wire.
- Mechanical shock should not be applied to the products mounted on the board to prevent the breaking of the core.

9.10 Notice of product handling at mounting

In some mounting machines,when picking up components support pin pushes up the components from the bottom of base tape. In this case, please remove the support pin. The support pin may damage the components and break wire.

In rare case ,the laser recognition can not recognize this component. Please contact us when you use laser recognition. (There is no problem with the permeation and reflection type.)

9.11 Handling of a substrate

After mounting products on a substrate, do not apply any stress to the product caused by bending or twisting to the substrate when cropping the substrate, inserting and removing a connector from the substrate or tightening screw to the substrate.

Excessive mechanical stress may cause cracking in the product.

Bending

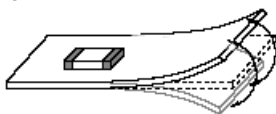

Twisting

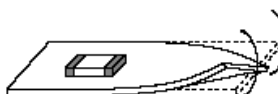

9.12 Storage and Handling Requirements

- (1) Storage period
 - Use the products within 12 months after delivered.
 - Solderability should be checked if this period is exceeded.
- (2) Storage conditions
 - Products should be stored in the warehouse on the following conditions.
 - Temperature : -10°C to 40°C
 - Humidity : 15% to 85% relative humidity No rapid change on temperature and humidity
 - Don't keep products in corrosive gases such as sulfur, chlorine gas or acid, or it may cause oxidation of electrode, resulting in poor solderability.
 - Products should not be stored on bulk packaging condition to prevent the chipping of the core and the breaking of winding wire caused by the collision between the products.
 - Products should be stored on the palette for the prevention of the influence from humidity, dust and so on.
 - Products should be stored in the warehouse without heat shock, vibration, direct sunlight and so on.
- (3) Handling Condition
 - Care should be taken when transporting or handling product to avoid excessive vibration or mechanical shock.

10. ⚠ Note

- (1) Please make sure that your product has been evaluated in view of your specifications with our product being mounted to your product.
- (2) You are requested not to use our product deviating from the reference specifications.
- (3) The contents of this reference specification are subject to change without advance notice.
Please approve our product specifications or transact the approval sheet for product specifications before ordering.

<Electrical Performance: Measuring Method of Inductance / Q>

(1) Residual elements and stray elements of test fixture can be described by F-parameter shown in following.

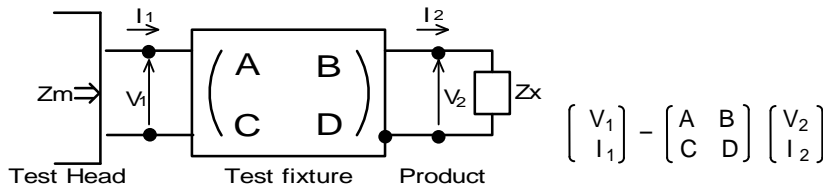

(2) The impedance of chip coil Z_x and measured value Z_m can be described by input/output current/voltage.

$$Z_m = \frac{V_1}{I_1} \quad , \quad Z_x = \frac{V_2}{I_2}$$

(3) Thus, the relation between Z_x and Z_m is following;

$$Z_x = \alpha \frac{Z_m - \beta}{1 - Z_m \Gamma} \quad \text{where, } \alpha = D / A = 1$$

$$\beta = B / D = Z_{sm} - (1 - Y_{om} Z_{sm}) Z_{ss}$$

$$\Gamma = C / A = Y_{om}$$

Z_{sm} : measured impedance of short chip
 Z_{ss} : residual impedance of short chip (0.771nH)
 Y_{om} : measured admittance when opening the fixture

(4) L_x and Q_x shall be calculated with the following equation.

$$L_x = \frac{\text{Im}(Z_x)}{2\pi f} \quad , \quad Q_x = \frac{\text{Im}(Z_x)}{\text{Re}(Z_x)} \quad \begin{array}{l} L_x : \text{Inductance of chip coil} \\ Q_x : \text{Q of chip coil} \\ f : \text{Measuring frequency} \end{array}$$