

THIS DOCUMENT IS THE PROPERTY OF
KEYSTONE ELECTRONICS CORP. AND
SHALL NOT BE REPRODUCED, DISTRIBUTED
OR USED AS A BASIS FOR MANUFACTURE
WITHOUT PRIOR WRITTEN PERMISSION
FROM KEYSTONE ELECTRONICS CORP.

ACTUAL SIZE

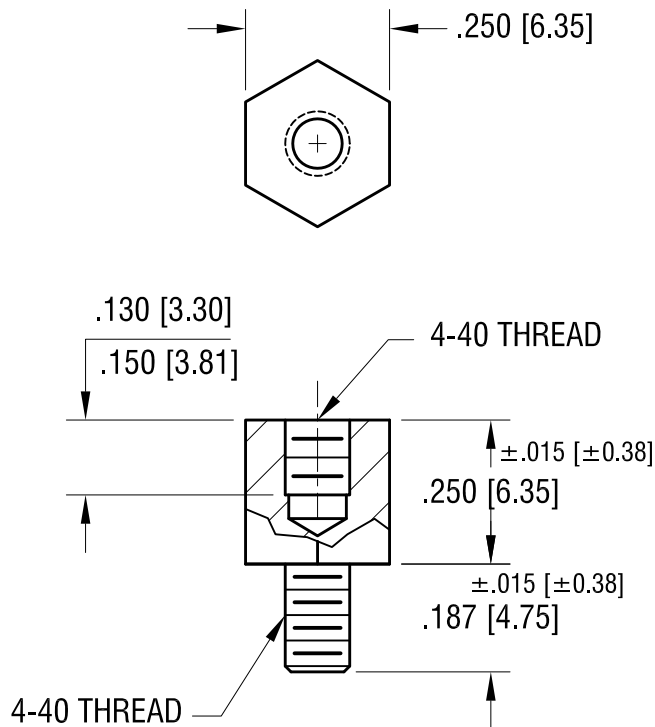

NOTE:

1. MAT'L- HIGH TEMPERATURE ,
HIGH PERFORMANCE NYLON BLEND (COLOR- BLACK)
2. TEMPERATURE RANGE: -20°F [-28°C] to +400°F [+200°C]

KEYSTONE ELECTRONICS CORP.			
www.keyelco.com • NEW HYDE PARK, NY 11040 • Tel (516) 328-7500			
PART NAME			
HIGH TEMPERATURE NYLON STANDOFF			
MATERIAL			
AS NOTED			
FINISH		DRN BY	DATE
NONE		NT	11.30.17
		APP'D	SCALE
		LN	3X
TOLERANCES	INCH [MM]	CODE	DWG NO.
DECIMAL	± .005 [± 0.13]	C	4940
ANGULAR	± 1°		
UNLESS OTHERWISE SPECIFIED			

DATE	DESCRIPTION	REV.	
------	-------------	------	--