

PRELIMINARY SPEC

Part Number: AT2520ZG10ZS Green



ATTENTION
OBSERVE PRECAUTIONS
FOR HANDLING
ELECTROSTATIC
DISCHARGE
SENSITIVE
DEVICES

Features

- Dimension: 2.5mmx 2.0mm x 0.8mm.
- Low thermal resistance.
- Ceramic package with silicone resin.
- Small package with high efficiency.
- Surface mount technology.
- ESD protection.
- Package : 2000pcs / reel.
- Moisture sensitivity level : level 2a.
- Soldering methods: IR reflow soldering.
- RoHS compliant.

Application Note

Static electricity and surge damage the LEDs.
It is recommended to use a wrist band or anti-electrostatic glove when handling the LEDs.
All devices, equipment and machinery must be electrically grounded.

Typical Applications

- PDA's
- Room lighting
- Architectural lighting
- Decorative/pathway lighting
- Front panel backlight
- Exterior automotive lighting:
(brake lights, turn lights, backlighting)

Package Dimensions

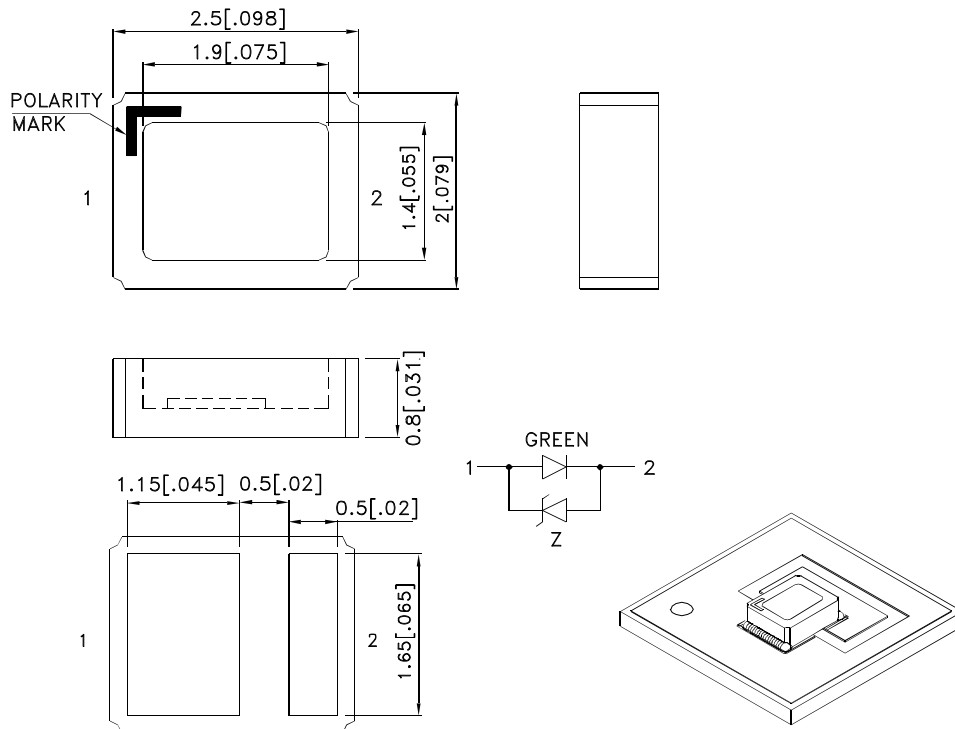

Notes:

1. All dimensions are in millimeters (inches).
2. Tolerance is $\pm 0.25(0.01)$ unless otherwise noted.
3. Specifications are subject to change without notice.
4. The device has a single mounting surface. The device must be mounted according to the specifications.



Handling Precautions

Compare to epoxy encapsulant that is hard and brittle, silicone is softer and flexible. Although its characteristic significantly reduces thermal stress, it is more susceptible to damage by external mechanical force.

As a result, special handling precautions need to be observed during assembly using silicone encapsulated LED products. Failure to comply might leads to damage and premature failure of the LED.

1. Handle the component along the side surfaces by using forceps or appropriate tools.

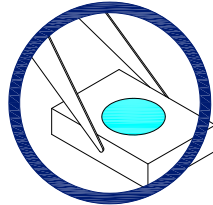

2. Do not directly touch or handle the silicone lens surface. It may damage the internal circuitry.

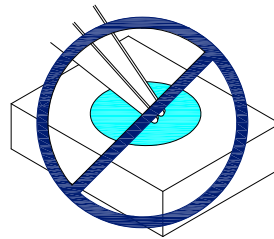
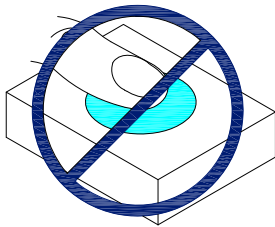

3. Do not stack together assembled PCBs containing exposed LEDs. Impact may scratch the silicone lens or damage the internal circuitry.

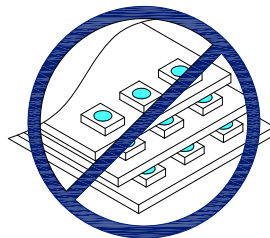

4. The outer diameter of the SMD pickup nozzle should not exceed the size of the LED to prevent air leaks. The inner diameter of the nozzle should be as large as possible.

5. A pliable material is suggested for the nozzle tip to avoid scratching or damaging the LED surface during pickup.

6. The dimensions of the component must be accurately programmed in the pick-and-place machine to insure precise pickup and avoid damage during production.

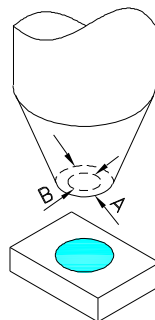

Selection Guide

Part No.	Dice	luminous Intensity [2] Iv(mcd)@ 250mA		Φv (lm) [2] @ 250mA		Viewing Angle [1]
		Min.	Typ.	Min.	Typ.	2 θ 1/2
AT2520ZG10ZS	Green (AlInGaN)	7500	10000	30	38	120 °

Notes:

- θ1/2 is the angle from optical centerline where the luminous intensity is 1/2 the optical centerline value.
- Luminous intensity/ luminous Flux: +/-15%.

Absolute Maximum Ratings at TA=25°C

Parameter	Symbol	Value	Unit
Power dissipation	Pt	1.0	W
Junction temperature[1]	TJ	110	°C
Operating Temperature	Top	-40 To +100	°C
Storage Temperature	Tstg	-40 To +120	°C
DC Forward Current [1]	IF	250	mA
Peak Forward Current [2]	IFM	400	mA
Thermal resistance [1]	Rth j-a	120	°C/W
Electrostatic Discharge Threshold (HBM)		8000	V

Notes:

- Results from mounting on PC board FR4, mounted on pc board-metal core PCB is recommend for lowest thermal resistance.
- 1/10 Duty Cycle, 0.1ms Pulse Width.

Electrical / Optical Characteristics at TA=25°C

Parameter	Symbol	Value	Unit
Wavelength at peak emission IF=250mA [Typ.]	λ peak	520	nm
Dominant Wavelength IF=250mA [Typ.]	λ dom [1]	530	nm
Spectral bandwidth at 50%Φ REL MAX IF=250mA [Typ.]	Δλ	35	nm
Forward Voltage IF=250mA [Min.]	VF [2]	3.0	V
Forward Voltage IF=250mA [Typ.]		3.6	
Forward Voltage IF=250mA [Max.]		4.0	
Temperature coefficient of λ peak IF=250mA, -10 ° C ≤ T ≤ 100 ° C [Typ.]	TC λ peak	0.15	nm/°C
Temperature coefficient of λ dom IF=250mA, -10 ° C ≤ T ≤ 100 ° C [Typ.]	TC λ dom	0.12	nm/°C
Temperature coefficient of VF IF=250mA, -10 ° C ≤ T ≤ 100 ° C [Typ.]	TCv	-3.0	mV/°C

Notes:

- Wavelength: +/-1nm.
- Forward Voltage: +/-0.1V.

Green

AT2520ZG10ZS

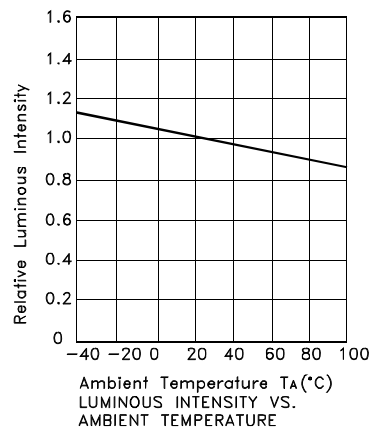
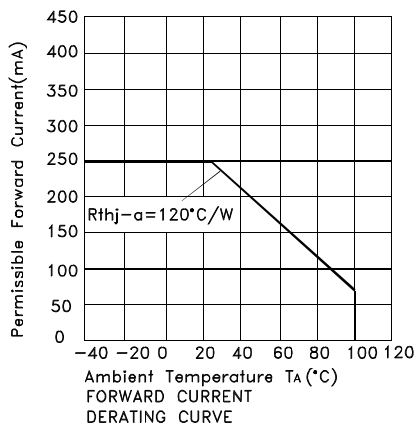
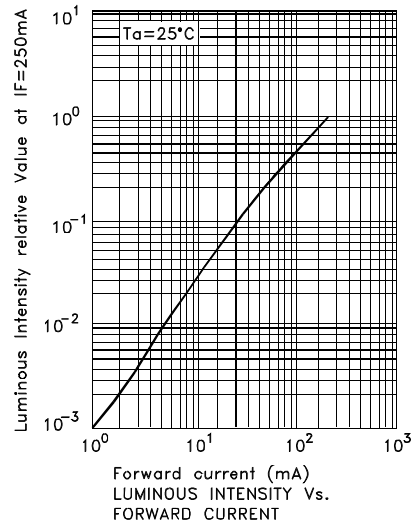
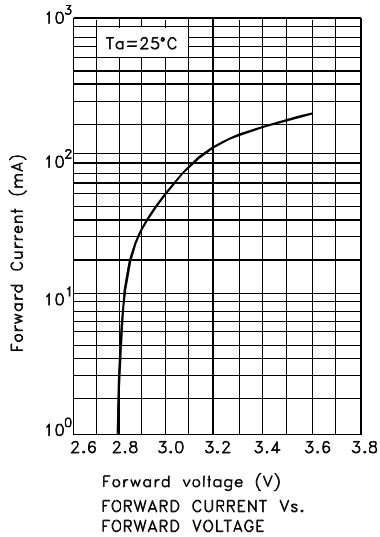
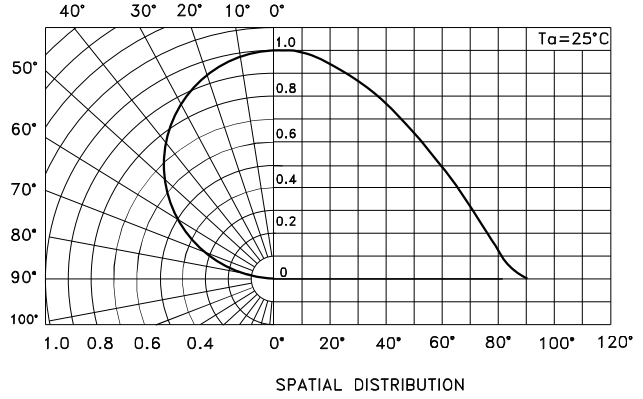
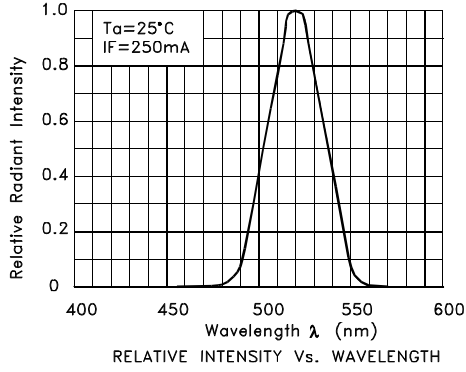

AT2520ZG10ZS

Reflow soldering is recommended and the soldering profile is shown below.
Other soldering methods are not recommended as they might cause damage to the product.

Reflow Soldering Profile For Lead-free SMT Process.

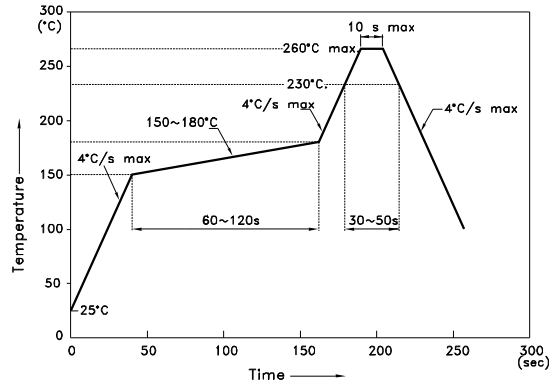

NOTES:

1. We recommend the reflow temperature 245°C(+/-5°C). The maximum soldering temperature should be limited to 260°C.
2. Don't cause stress to the epoxy resin while it is exposed to high temperature.
3. Number of reflow process shall be 2 times or less.

Recommended Soldering Pattern (Units : mm; Tolerance: ± 0.1)

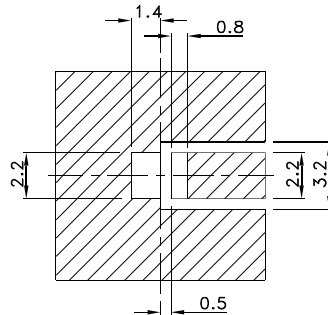

Solder resist

Tape Specifications (Units : mm)

