

## ISOLATED DC/DC CONVERTERS

36 Vdc - 75 Vdc Input, 5 Vdc/20 A Output



Nov 05, 2009

Bel Power, Inc., a subsidiary of Bel Fuse, Inc.

0REB-C0T05x RoHS Compliant PRELIMINARY Rev.B

### Features

- Isolated
- High Efficiency
- Fixed Frequency (310 KHz)
- High Power Density
- Low Cost
- Class 1, Category 2, Isolated DC/DC Converter (refer to IPC-9592)
- UL60950-1 Recognized (UL/cUL) (Pending)
- Input Under Voltage Protection
- Output Over-Voltage Protection
- OCP/SCP
- Over Temperature Protection
- Remote On/Off

### Applications

- Networking
- Computers and peripherals
- Telecommunications

### Description

The 0REB-C0T05x is an isolated dc/dc converter that operates from a nominal 48 Vdc source. This converter provides up to 100 W of output power. Features include remote on/off, short circuit protection, over current protection, over-temperature protection, output over-voltage protection, input under-voltage protection.

### Part Selection

Output Voltage	Input Voltage	Max. Output Current	Max. Output Power	Typical Efficiency	Model Number Active Low	Model Number Active High
5 Vdc	36 Vdc - 75 Vdc	20 A	100 W	92%	0REB-C0T05L	0REB-C0T050

Notes: Add "G" suffix at the end of the model number to indicate Tray Packaging.

### Part Number Explanation

0 R EB - C0 T 05 L  
1 2 3 4 5 6 7

- 1---Through hole mount
- 2---RoHS 6, change "R" to "7" means RoHS 5
- 3---Series name
- 4---Series code
- 5---Input range (36-75V)
- 6---Output voltage (5V)
- 7--- Enable, active low, change "L" to "0" means active high

# ISOLATED DC/DC CONVERTERS

36 Vdc - 75 Vdc Input, 5 Vdc/20 A Output



Nov 05, 2009

Bel Power, Inc., a subsidiary of Bel Fuse, Inc.

## Absolute Maximum Ratings

Parameter	Min	Typ	Max	Unit	Notes
Continuous non-operating Input Voltage	-0.3	-	80	V	
Input Transient Voltage	-	-	100	V	100mS maximum
Remote On/Off	-0.3	-	18	V	
I/O isolation voltage	-	-	1500	V	
Ambient Temperature	-40	-	85	°C	
Storage Temperature	-55	-	125	°C	

**Note:** Ratings used beyond the maximum ratings may cause a reliability degradation of the converter or may permanently damage the device.

## Input Specifications

Parameter	Min	Typ	Max	Unit	Notes
Operating Input Voltage	36	48	75	V	
Input Current (full load)	-	-	3.8	A	
Input Current (no load)	-	50	120	mA	
Remote Off Input Current	-	2	5	mA	
Input Reflected Ripple Current (rms)	-	2	5	mA	With simulated source impedance of 10uH, 5Hz to 20MHz. Use a 100uF/100V electrolytic capacitor with ESR=1 ohm max, at 200KHz@25°C.
Input Reflected Ripple Current (pk-pk)	-	10	30	mA	
I <sup>2</sup> t Inrush Current Transient	-	-	1	A <sup>2</sup> s	
Turn-on Voltage Threshold	32	34	35	V	
Turn-off Voltage Threshold	30	32	34	V	

**CAUTION:** This converter is not internally fused. An input line fuse must be used in application.

Recommend a fast-acting fuse with maximum rating of 5A on system board. Refer to the fuse manufacturer's datasheet for further information.

**Notes:** 1. This converter has internal C-L-C (0.47uF-2.2uH-4.4uF) filter.

2. All specifications are typical at 25 °C unless otherwise stated.

## Output Specifications

Parameter	Min	Typ	Max	Unit	Notes
Output Voltage Set Point	4.9	5	5.1	V	Vin=48V, Io=50% load
Load Regulation	-	0.1	0.2	% Vo,set	Vin=48V, Io=0~100% load
Line Regulation	-	0.1	0.2	% Vo,set	Vin=36~75V, Io=100% load
Regulation Over Temperature (-40deg.C-85deg.C)	-	-	1	% Vo,set	
Ripple and Noise (pk-pk)	-	60	100	mV	Vin=48V, Io=100%load at 25°C ambient, 0-20MHz BW, with a 1µF ceramic capacitor and a 10uF Tantalum cap at output.
Ripple and Noise (rms)	-	15	30	mV	
Ripple and Noise (pk-pk) under worst case	-	-	150	mV	over all operating input voltage, load and ambient temperature condition

# ISOLATED DC/DC CONVERTERS

36 Vdc - 75 Vdc Input, 5 Vdc/20 A Output



Nov 05, 2009

Bel Power, Inc., a subsidiary of Bel Fuse, Inc.

## Output Specifications (continued)

Parameter	Min	Typ	Max	Unit	Notes	
Output Current Range	0	-	20	A		
Output DC Current Limit	22	25	35	A		
Short Circuit Surge Transient	-	-	TBD	A <sup>2</sup> s		
Rise time	-	-	10	mS		
Turn on Time	-	-	20	mS	Enable form Vin	
	-	-	20	mS	Enable form ON/OFF	
Overshoot at Turn on	-	0	3	%		
Output Capacitance	0	-	10000	uF		
<b>Transient Response</b>						
$\Delta V$ 50%~75% of Max Load	Overshoot	-	100	150	mV	di/dt=0.1A/us, Vin=48Vdc, Ta=25°C, with a 1μF ceramic capacitor and a 10uF Tantalum cap at output.
	Settling Time	-	200	400	uS	
$\Delta V$ 75%~50% of Max Load	Overshoot	-	100	150	mV	
	Settling Time	-	200	400	uS	

**Note:** All specifications are typical at nominal input, full load at 25°C unless otherwise stated.

## General Specifications

Parameter	Min	Typ	Max	Unit	Notes
Efficiency	90	92	-	%	Vin=48V, full load
Switching Frequency	290	310	330	kHz	
Over Temperature Protection	-	120	130	°C	
Output Voltage Trim Range	80	-	110	%	
Over Voltage Protection(Static)	5.8	-	7	V	This voltage is achieved by trimming up output slowly.
Over Voltage Protection (Dynamic)	-	-	7	V	The transient over voltage is achieved by connecting the Trim pin to Vout+ pin through a 1K resistor.
Isolation Capacitance	-	1500	-	pF	
Input to Output	-	-	1500	Vdc	
Input to Case	-	-	1500	Vdc	
Output to Case	-	-	500	Vdc	
Isolation Resistance	10M	-	-	Ohm	
Weight	-	TBD	-	g	
FIT	350			-	Calculated Per Bell Core SR-332 (Vin=48V, Vo=1.2V, Io=20A, Ta = 25 °C, FIT=10 <sup>9</sup> /MTBF)
Dimensions	Inches (L x W x H) Millimeters (L x W x H)			-	
	2.30 x 0.90 x 0.43 58.42 x 22.86 x 11.0				

**Note:** All specifications are typical at 25 °C unless otherwise stated.

# ISOLATED DC/DC CONVERTERS

36 Vdc - 75 Vdc Input, 5 Vdc/20 A Output



Nov 05, 2009

Bel Power, Inc., a subsidiary of Bel Fuse, Inc.

## Efficiency Data

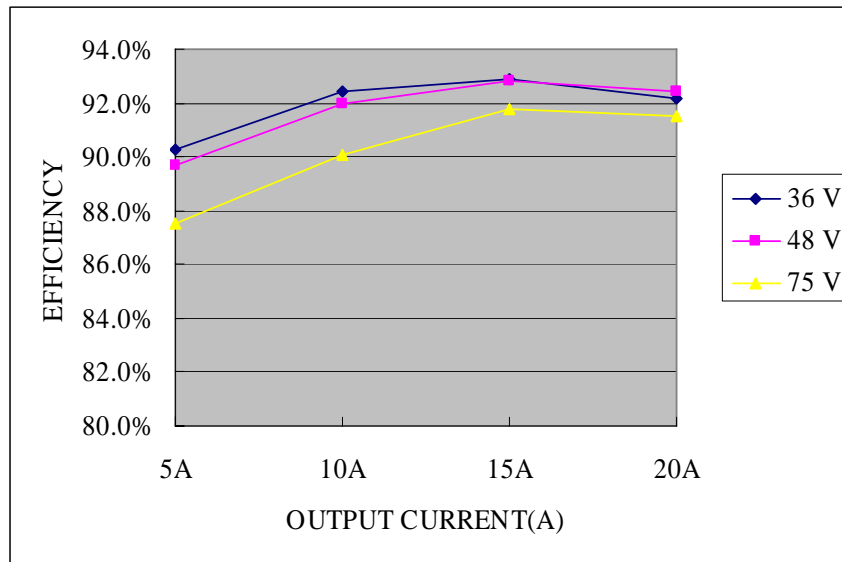

## Input Under-voltage Lockout

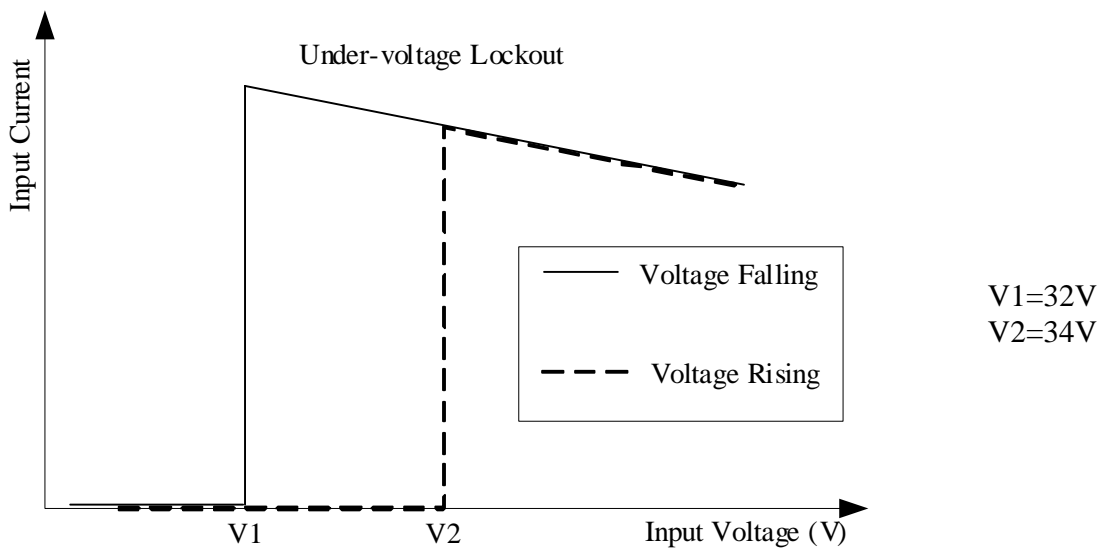

# ISOLATED DC/DC CONVERTERS

36 Vdc - 75 Vdc Input, 5 Vdc/20 A Output



Nov 05, 2009

Bel Power, Inc., a subsidiary of Bel Fuse, Inc.

## Remote On/Off

Parameter		Min	Typ	Max	Unit	Notes
Signal Low (Unit On)	Active Low	-0.3	-	0.8	V	The remote on/off pin open, Unit off.
Signal High (Unit Off)		2.4	-	18	V	
Signal Low (Unit Off)	Active High	-0.3	-	0.8	V	The remote on/off pin open, Unit on.
Signal High (Unit On)		2.4	-	18	V	
Current Sink		0	-	1	mA	

### Recommended remote on/off circuit for active low

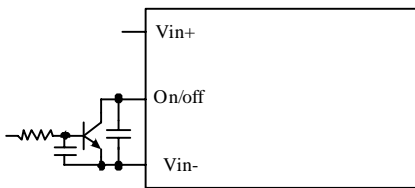

Control with open collector/drain circuit

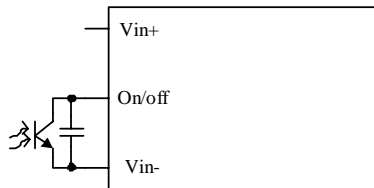

Control with photocoupler circuit

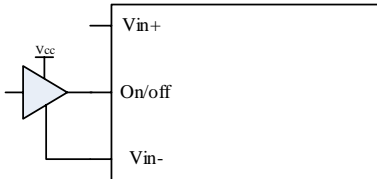

Control with logic circuit

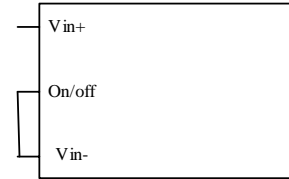

Permanently on

### Recommended remote on/off circuit for active high

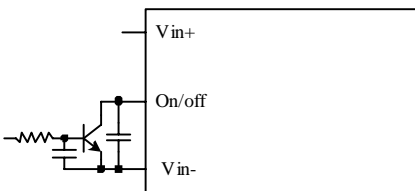

Control with open collector/drain circuit

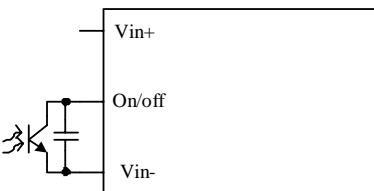

Control with photocoupler circuit

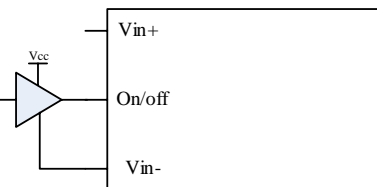

Control with logic circuit

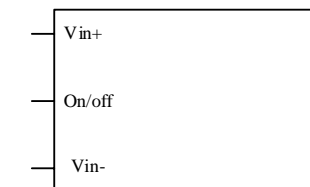

Permanently on

# ISOLATED DC/DC CONVERTERS

36 Vdc - 75 Vdc Input, 5 Vdc/20 A Output



Nov 05, 2009

Bel Power, Inc., a subsidiary of Bel Fuse, Inc.

## Output Trim Equations

Equations for calculating the trim resistor are shown below. The Trim Down resistor should be connected between the Trim pin and Sense (-) pin. The Trim Up resistor should be connected between the Trim pin and the Sense (+). Only one of the resistors should be used for any given application.

Minimum trim down voltage is 4.5V

Maximum trim up voltage is 5.5V.

The total voltage increased by trim and remote sense should not exceed 10% of the nominal output voltage.

$$R_{trimdown} = \frac{511}{\Delta\%} - 10.2[k\Omega]$$

$$R_{trimup} = \frac{5.11 \times V_o \times (100 + \Delta\%)}{1.225 \times \Delta\%} - \frac{510}{\Delta\%} - 10.2[k\Omega]$$

**Note:** 
$$\Delta\% = \left| \frac{V_{DES} - V_o}{V_o} \right| \times 100$$

$V_{DES}$  = Desired(trimmed) output voltage[V]

$V_o$  = Normal output voltage(5V)

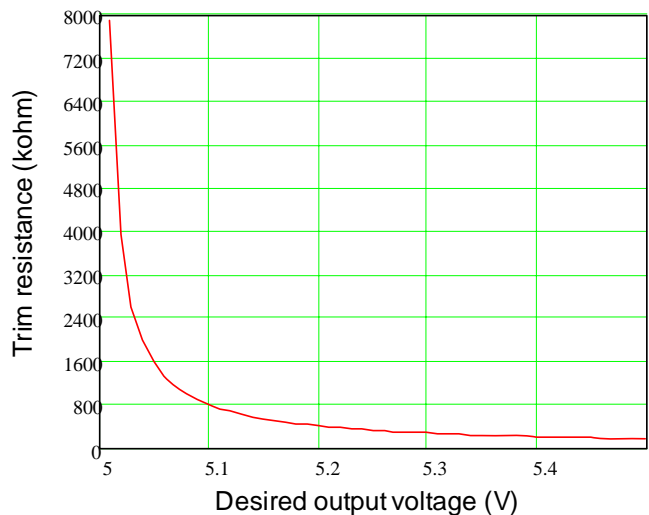
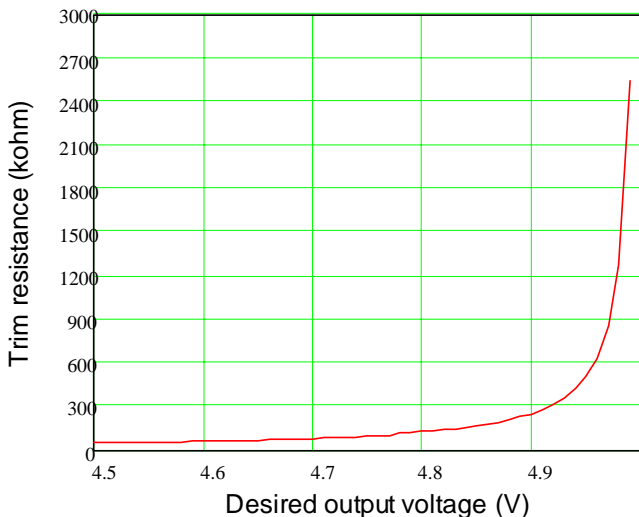
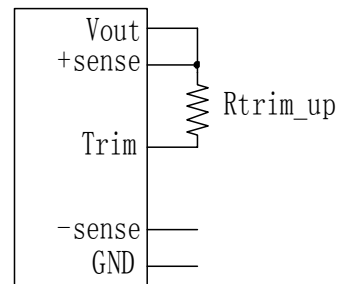
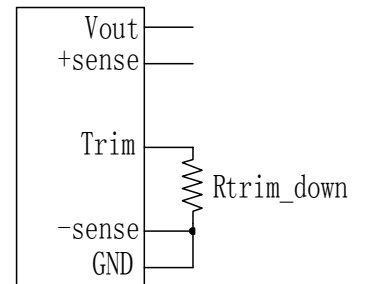

## ISOLATED DC/DC CONVERTERS

36 Vdc - 75 Vdc Input,

5 Vdc/20 A Output

**bel**

Nov 05, 2009

*Bel Power, Inc. , a subsidiary of Bel Fuse, Inc.*

### Remote Sense

This module has remote sense compensation feature. It can minimize the effects of resistance between module's output and load in system layout and facilitates accurate voltage regulation at load terminals or other selected point.

1. The remote sense lines carries very little current and hence do not require a large cross-sectional area.
2. This module compensates for a maximum drop of 10% of the nominal output voltage.
3. If the unit is already trimmed up, the available remote sense compensation range should be correspondingly reduced. The total voltage increased by trim and remote sense should not exceed 10% of the nominal output voltage.
4. When using remote sense compensation, all the resistance, parasitic inductance and capacitance of the system are incorporated within the feedback loop of this module. It can make an effect on the module's compensation, affecting the stability and dynamic response. A 0.1uF ceramic capacitor can be connected at the point of load to de-couple noise on the sense wires.
5. Recommend the connection of remote sense compensation as below figure. There are a resistor RS+ (10 ohm) from Vo+ to Sense+ and a resistor RS- (10 ohm) from Vo- to Sense- inside of this module.

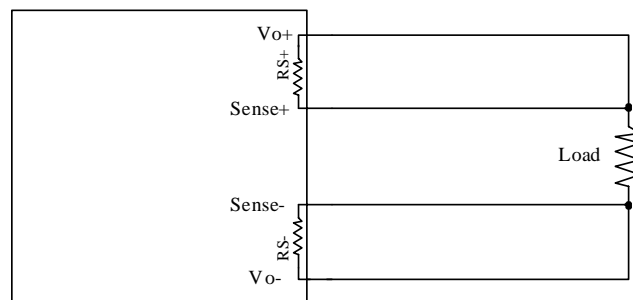

6. If not using remote sense compensation, please connect sense directly to output at module's pin, that is, connect sense+ to Vo+ and sense- to Vo- at module's pin, the shorter the better. See below figure.

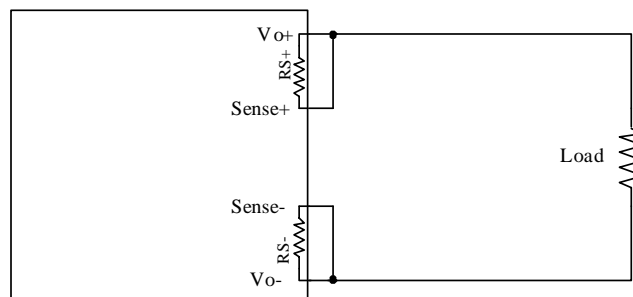

# ISOLATED DC/DC CONVERTERS

36 Vdc - 75 Vdc Input, 5 Vdc/20 A Output



Nov 05, 2009

Bel Power, Inc., a subsidiary of Bel Fuse, Inc.

## Safety & EMC

### Safety

1. Material flammability UL94V-0
2. TUV Certification EN60950-1
3. UL Certification UL60950-1

### EMC

1. Surge IEC61000-4-5
2. DC-DIP IEC61000-4-29
3. Conductive EMI EN55022 class A

Compliance to EN55022 class A (both q.peak and average) with the following inductive and capacitive filter

Setup:

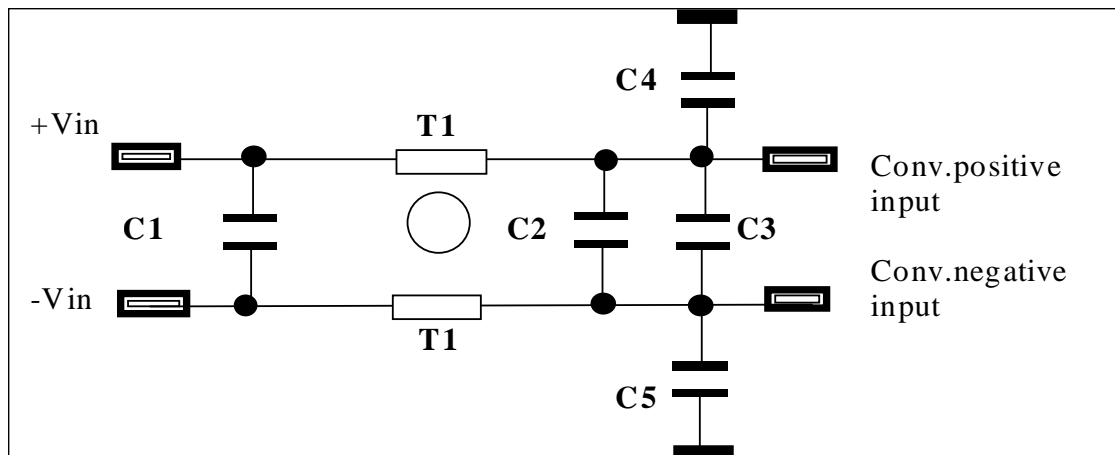

Item	Designator	Parameter	Vendor	Vendor P/N
1	C1	1uF/100V,ceramic	Murata	GRM32ER72A105KA01L
2	C2	0.1uF/100V, ceramic	TDK	C3216X7R2A104K
3	C3	100uF/100V, AL cap	Nichicon	UVZ2A101MPD
4	C4	22nF/1000V,ceramic	Johanson	631S41W223KV4E
5	C5	22nF/1000V,ceramic	Johanson	631S41W223KV4E
6	T1	1.3mH, common mode	Pulse	P0402NL



## ISOLATED DC/DC CONVERTERS

36 Vdc - 75 Vdc Input, 5 Vdc/20 A Output



Nov 05, 2009

*Bel Power, Inc. , a subsidiary of Bel Fuse, Inc.*

### Over Voltage Protection

The output over voltage protection consists of circuitry that monitors the voltage on the output terminals. If the voltage on the output terminals exceeds the over voltage protection threshold, the module will shutdown into hiccup mode and restart once every 700mS. The module operates normally when the fault is cleared.

Test setup:

$R \geq 1K$

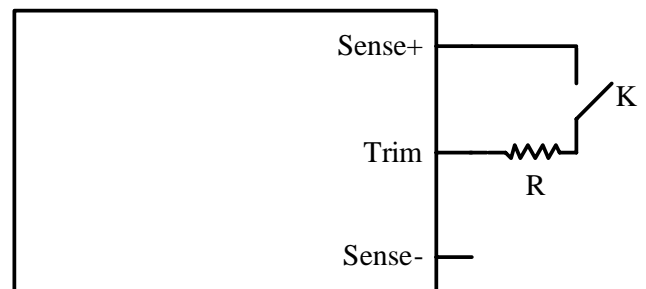
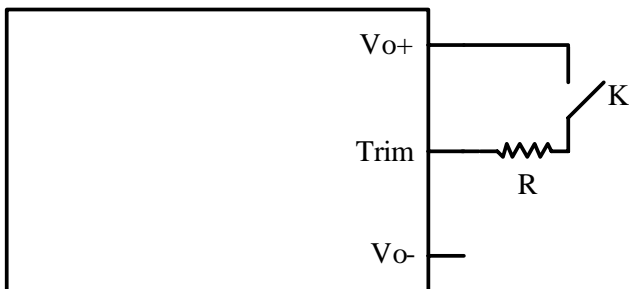

# ISOLATED DC/DC CONVERTERS

36 Vdc - 75 Vdc Input, 5 Vdc/20 A Output



Nov 05, 2009

Bel Power, Inc., a subsidiary of Bel Fuse, Inc.

## Mechanical Outline

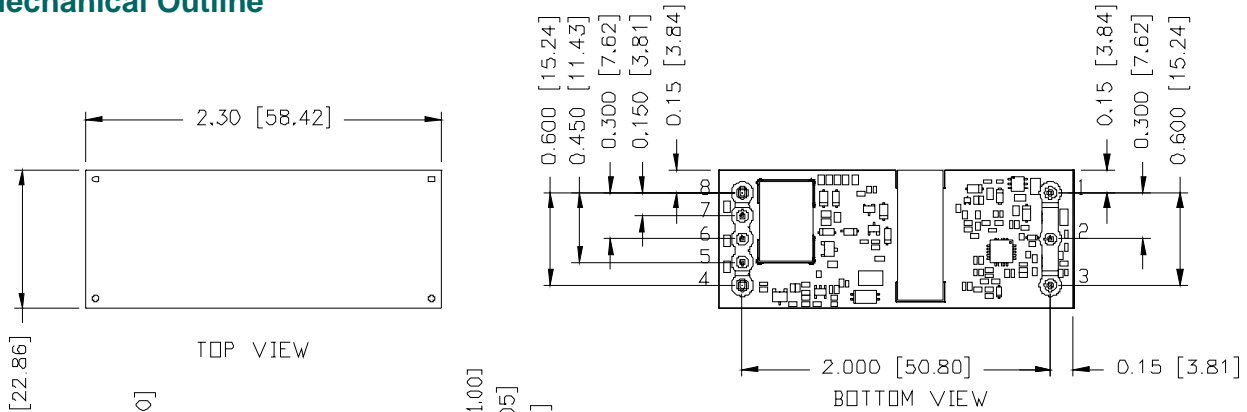

UNIT: INCH [mm]

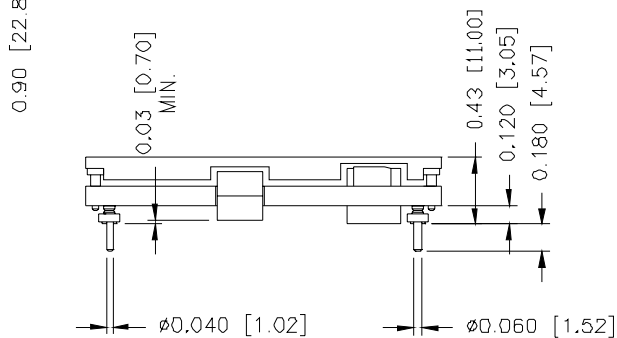

### RECOMMENDED PAD LAYOUT

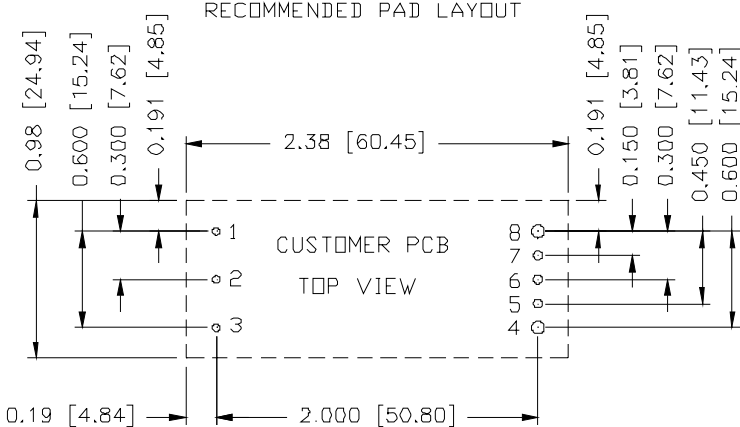

1,2,3,5,6,7  $\phi$ 0.047 HOLE SIZE,  $\phi$ 0.08 min PAD SIZE  
4,8  $\phi$ 0.07 HOLE SIZE,  $\phi$ 0.10 min PAD SIZE

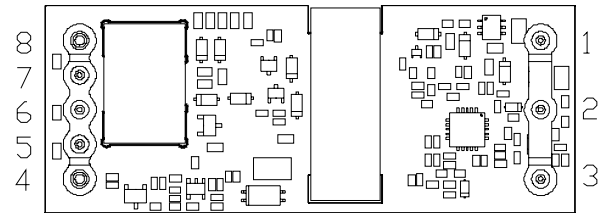

### BOTTOM VIEW

Pin	Function	Dia.	Pin	Function	Dia.
1	Vin(+)	0.04"	5	Sense(-)	0.04"
2	ON/OFF	0.04"	6	Trim	0.04"
3	Vin(-)	0.04"	7	Sense(+)	0.04"
4	Vout(-)	0.06"	8	Vout(+)	0.06"

**Note:** 1. Pin 5 must be connected to Vout(-).  
2. Pin 7 must be connected to Vout(+).

**Note:** This module is recommended and compatible with Pb-Free Wave Soldering and must be soldered using a peak solder temperature of no more than 260 °C for less than 5 seconds.

### Note:

- All Pins: Material - Copper Alloy;  
Finish – 3 micro inches minimum Gold over 50 micro inches minimum Nickel plate.
- Undimensioned components are shown for visual reference only.
- All dimensions in inches (mm); Tolerances: x.xx +/-0.02 in. (x.x +/-0.5mm) x.xxx +/-0.010 in. (x.xx +/-0.25mm).

## ISOLATED DC/DC CONVERTERS

36 Vdc - 75 Vdc Input, 5 Vdc/20 A Output



Nov 05, 2009

*Bel Power, Inc. , a subsidiary of Bel Fuse, Inc.*

### Revision History

Date	Revision	Changes Detail	Approval
2009-05-21	PA	First release	Joe Wei
2009-11-05	PB	<ol style="list-style-type: none"><li>1、 Update the max input voltage from 75V to 80V.</li><li>2、 Relax the typical efficiency from 92.5% to 92%.</li><li>3、 Change the max over current limit from 30A to 35A.</li><li>4、 Relax the output voltage trim range.</li></ol>	JZ Wang

### RoHS Compliance

Complies with the European Directive 2002/95/EC, calling for the elimination of lead and other hazardous substances from electronic products.



©2009 Bel Fuse Inc. Specifications subject to change without notice. 110509

11

#### CORPORATE

**Bel Fuse Inc.**  
206 Van Vorst Street  
Jersey City, NJ 07302  
Tel 201-432-0463  
Fax 201-432-9542  
[www.belfuse.com](http://www.belfuse.com)

#### FAR EAST

**Bel Fuse Ltd.**  
8F/ 8 Luk Hop Street  
San Po Kong  
Kowloon, Hong Kong  
Tel 852-2328-5515  
Fax 852-2352-3706  
[www.belfuse.com](http://www.belfuse.com)

#### EUROPE

**Bel Fuse Europe Ltd.**  
Preston Technology Management Centre  
Marsh Lane, Suite G7, Preston  
Lancashire, PR1 8UD, U.K.  
Tel 44-1772-556601  
Fax 44-1772-888366  
[www.belfuse.com](http://www.belfuse.com)