

High Voltage, High Gain BIMOSFET™ Monolithic Bipolar MOS Transistor

IXBF12N300

$$V_{CES} = 3000V$$

$$I_{C110} = 11A$$

$$V_{CE(sat)} \leq 3.2V$$

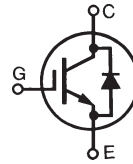

(Electrically Isolated Tab)

Symbol	Test Conditions	Maximum Ratings	
V_{CES}	$T_C = 25^\circ C$ to $150^\circ C$	3000	V
V_{CGR}	$T_J = 25^\circ C$ to $150^\circ C$, $R_{GE} = 1M\Omega$	3000	V
V_{GES}	Continuous	± 20	V
V_{GEM}	Transient	± 30	V
I_{C25}	$T_C = 25^\circ C$	26	A
I_{C110}	$T_C = 110^\circ C$	11	A
I_{CM}	$T_C = 25^\circ C$, 1ms	98	A
SSOA (RBSOA)	$V_{GE} = 15V$, $T_{VJ} = 125^\circ C$, $R_G = 20\Omega$	$I_{CM} = 98$	A
	Clamped Inductive Load	1500	V
P_C	$T_C = 25^\circ C$	125	W
T_J		-55 ... +150	$^\circ C$
T_{JM}		150	$^\circ C$
T_{stg}		-55 ... +150	$^\circ C$
T_L	1.6mm (0.062 in.) from Case for 10s	300	$^\circ C$
T_{SOLD}	Plastic Body for 10 seconds	260	$^\circ C$
F_C	Mounting Force	20..120 / 4.5..27	Nm/lb.in.
V_{ISOL}	50/60Hz, 1 Minute	4000	V~
Weight		5	g

ISOPLUS i4-Pak™

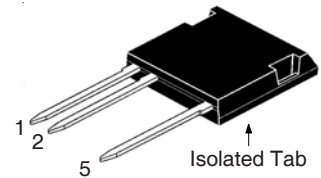

1 = Gate
2 = Emitter
5 = Collector

Features

- Silicon Chip on Direct-Copper Bond (DCB) Substrate
- Isolated Mounting Surface
- 4000V~ Electrical Isolation
- High Blocking Voltage
- High Peak Current Capability
- Low Saturation Voltage

Advantages

- Low Gate Drive Requirement
- High Power Density

Applications

- Switch-Mode and Resonant-Mode Power Supplies
- Capacitor Discharge Circuits
- Uninterrupted Power Supplies(UPS)
- Laser Drivers
- AC Switches

Symbol	Test Conditions ($T_J = 25^\circ C$ Unless Otherwise Specified)	Characteristic Values		
		Min.	Typ.	Max.
BV_{CES}	$I_C = 250\mu A$, $V_{GE} = 0V$	3000		V
$V_{GE(th)}$	$I_C = 250\mu A$, $V_{CE} = V_{GE}$	3.0		5.0 V
I_{CES}	$V_{CE} = 0.8 \cdot V_{CES}$, $V_{GE} = 0V$ Note 2, $T_J = 125^\circ C$			25 μA 1 mA
I_{GES}	$V_{CE} = 0V$, $V_{GE} = \pm 20V$			± 100 nA
$V_{CE(sat)}$	$I_C = I_{C90}$, $V_{GE} = 15V$, Note 1 $T_J = 125^\circ C$		2.8	3.2 V
			3.5	V

Symbol Test Conditions

($T_J = 25^\circ\text{C}$ Unless Otherwise Specified)

Characteristic Values

Symbol	Test Conditions	Characteristic Values		
		Min.	Typ.	Max.
g_{fs}	$I_C = I_{C90}, V_{CE} = 10V$, Note 1	6.5	10.8	S
C_{ies}	$V_{CE} = 25V, V_{GE} = 0V, f = 1\text{MHz}$		1290	pF
C_{oes}			56	pF
C_{res}			19	pF
Q_g	$I_C = I_{C90}, V_{GE} = 15V, V_{CE} = 1000V$		62	nC
Q_{ge}			13	nC
Q_{gc}			8.5	nC
$t_{d(on)}$	Resistive Switching Times, $T_J = 25^\circ\text{C}$ $I_C = I_{C90}, V_{GE} = 15V$ $V_{CE} = 1250V, R_G = 10\Omega$		64	ns
t_r			140	ns
$t_{d(off)}$			180	ns
t_f			540	ns
$t_{d(on)}$	Resistive Switching Times, $T_J = 125^\circ\text{C}$ $I_C = I_{C90}, V_{GE} = 15V$ $V_{CE} = 1250V, R_G = 10\Omega$		65	ns
t_r			395	ns
$t_{d(off)}$			175	ns
t_f			530	ns
R_{thJC}				1.00 $^\circ\text{C/W}$
R_{thCS}		0.15		$^\circ\text{C/W}$

ISOPLUS i4-Pak™ (HV) Outline

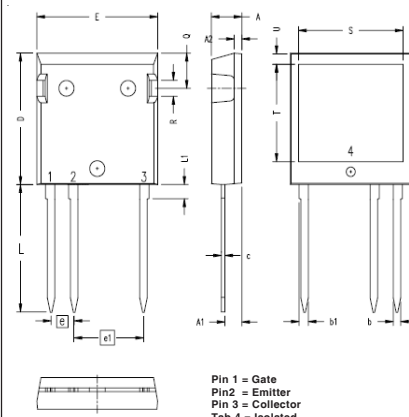

SYM	INCHES		MILLIMETERS	
	MIN	MAX	MIN	MAX
A	.190	.205	4.83	5.21
A1	.102	.118	2.59	3.00
A2	.046	.085	1.17	2.16
b	.045	.055	1.14	1.40
b1	.058	.068	1.47	1.73
C	.020	.029	0.51	0.74
D	.819	.840	20.80	21.34
E	.770	.799	19.56	20.29
e	.150 BSC		3.81 BSC	
e1	.450 BSC		11.43 BSC	
L	.780	.840	19.81	21.34
L1	.083	.102	2.11	2.59
Q	.210	.244	5.33	6.20
R	.100	.180	2.54	4.57
S	.660	.690	16.76	17.53
T	.590	.620	14.99	15.75
U	.065	.080	1.65	2.03

Reverse Diode

Symbol Test Conditions

($T_J = 25^\circ\text{C}$ Unless Otherwise Specified)

Characteristic Values

Symbol	Test Conditions	Characteristic Values		
		Min.	Typ.	Max.
V_F	$I_F = 12A, V_{GE} = 0V$			2.1 V
t_{rr}	$I_F = 6A, V_{GE} = 0V, -di_F/dt = 100A/\mu\text{s}$ $V_R = 100V, V_{GE} = 0V$		1.4	μs
I_{RM}			21	A

Notes:

1. Pulse test, $t \leq 300\mu\text{s}$, duty cycle, $d \leq 2\%$.
2. Device must be heatsunk for high temperature leakage current measurements to avoid thermal runaway.

IXYS Reserves the Right to Change Limits, Test Conditions and Dimensions.

IXYS MOSFETs and IGBTs are covered by one or more of the following U.S. patents:	4,835,592	4,931,844	5,049,961	5,237,481	6,162,665	6,404,065 B1	6,683,344	6,727,585	7,005,734 B2	7,157,338B2
	4,860,072	5,017,508	5,063,307	5,381,025	6,259,123 B1	6,534,343	6,710,405 B2	6,759,692	7,063,975 B2	
	4,881,106	5,034,796	5,187,117	5,486,715	6,306,728 B1	6,583,505	6,710,463	6,771,478 B2	7,071,537	

Fig. 1. Output Characteristics @ $T_J = 25^\circ\text{C}$

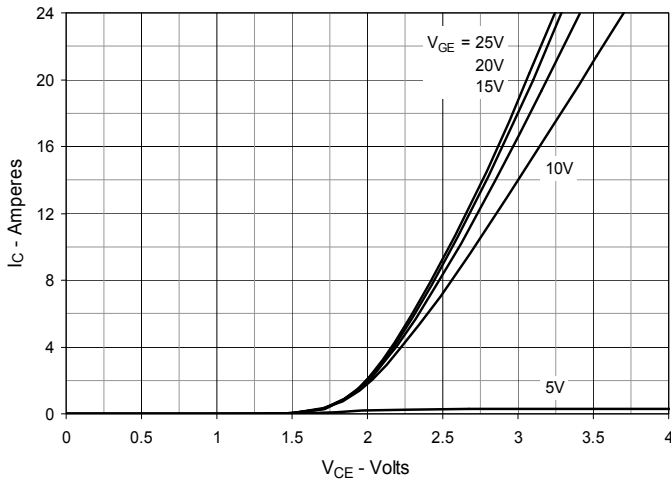

Fig. 2. Extended Output Characteristics @ $T_J = 25^\circ\text{C}$

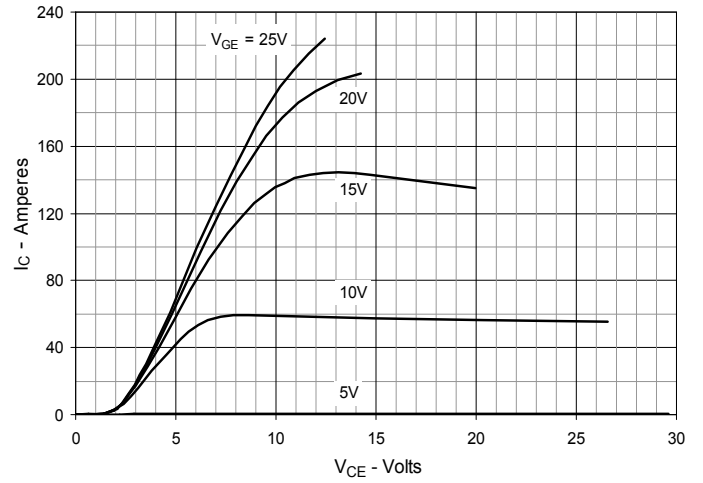

Fig. 3. Output Characteristics @ $T_J = 125^\circ\text{C}$

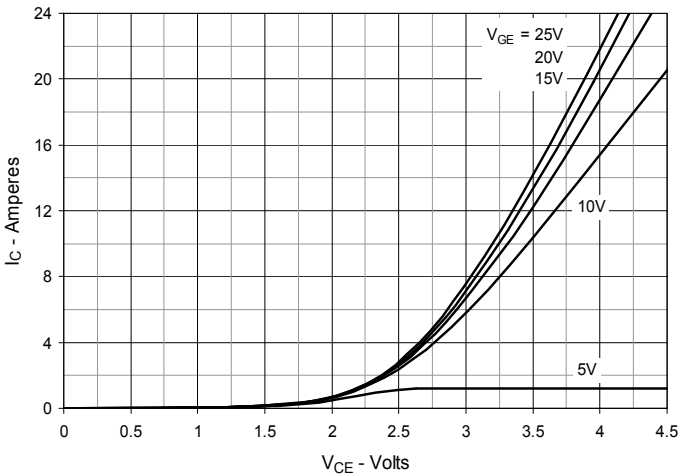

Fig. 4. Dependence of $V_{CE(sat)}$ on Junction Temperature

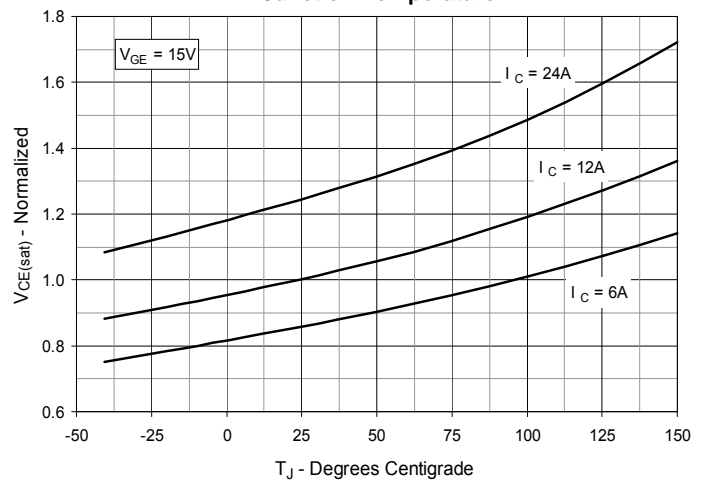

Fig. 5. Collector-to-Emitter Voltage vs. Gate-to-Emitter Voltage

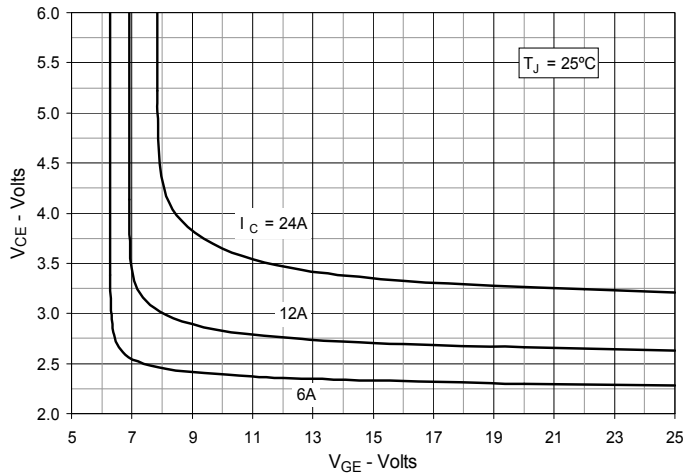

Fig. 6. Input Admittance

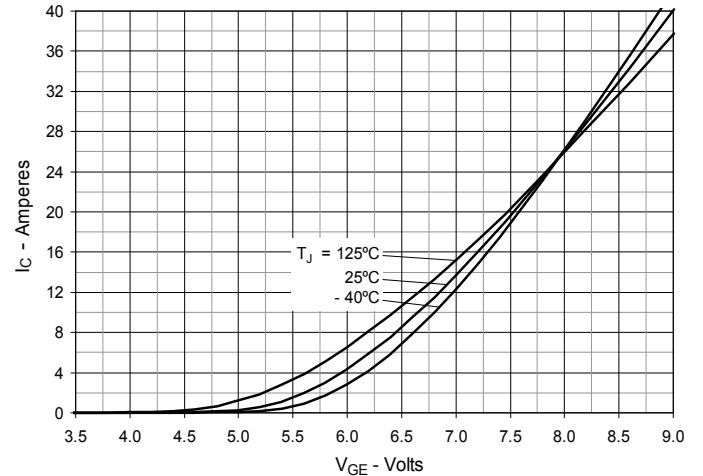

Fig. 7. Transconductance

Fig. 8. Forward Voltage Drop of Intrinsic Diode

Fig. 9. Gate Charge

Fig. 10. Capacitance

Fig. 11. Reverse-Bias Safe Operating Area

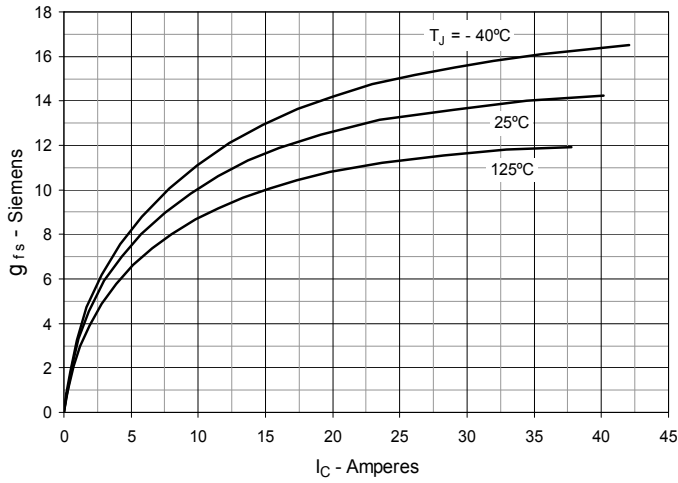
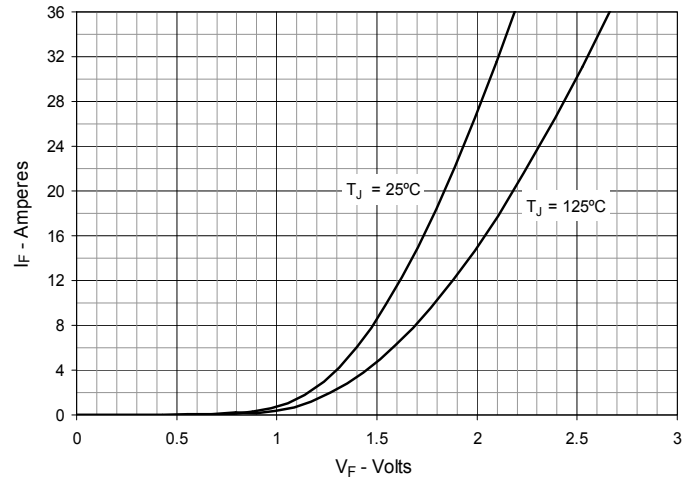
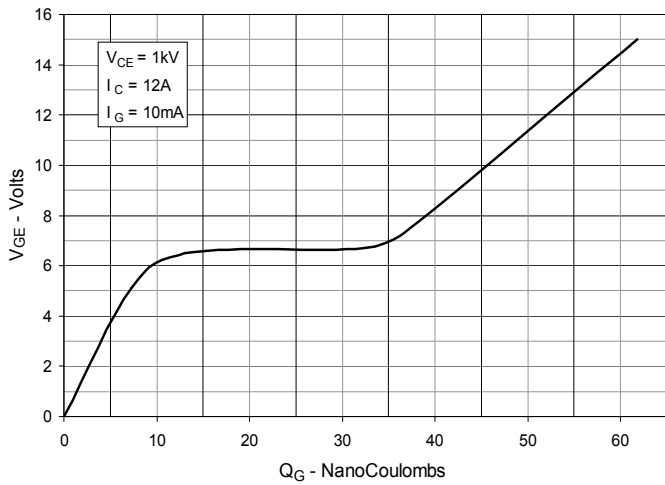
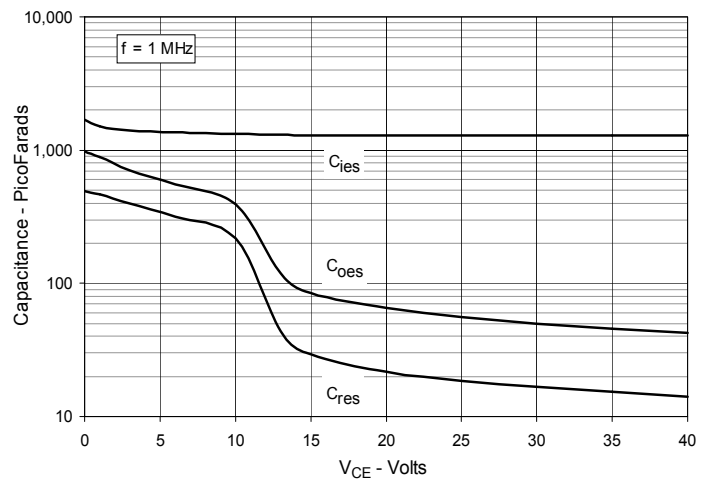
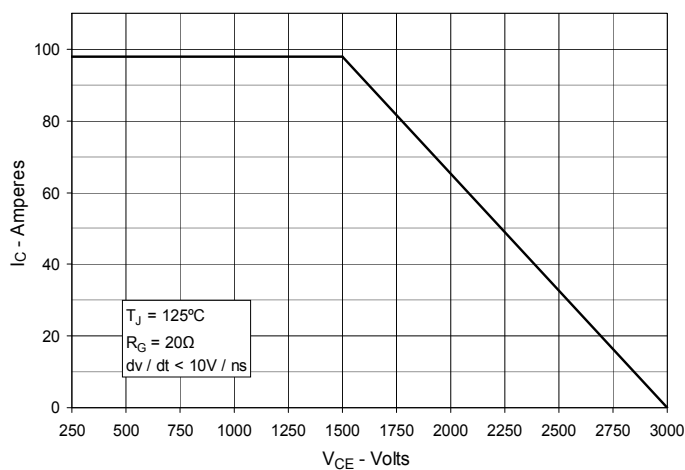
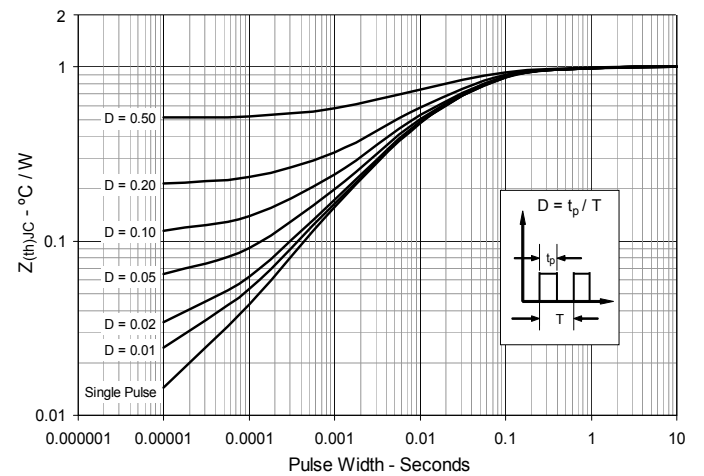
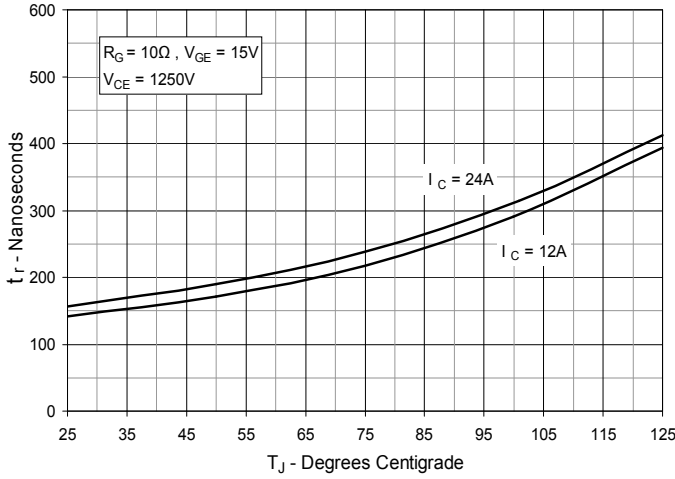
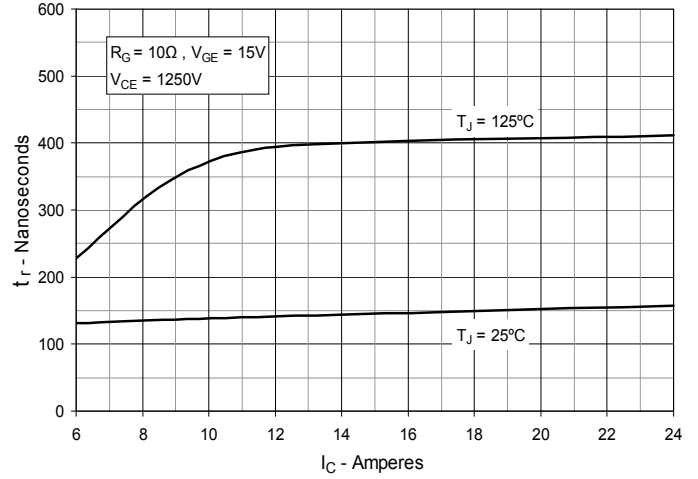
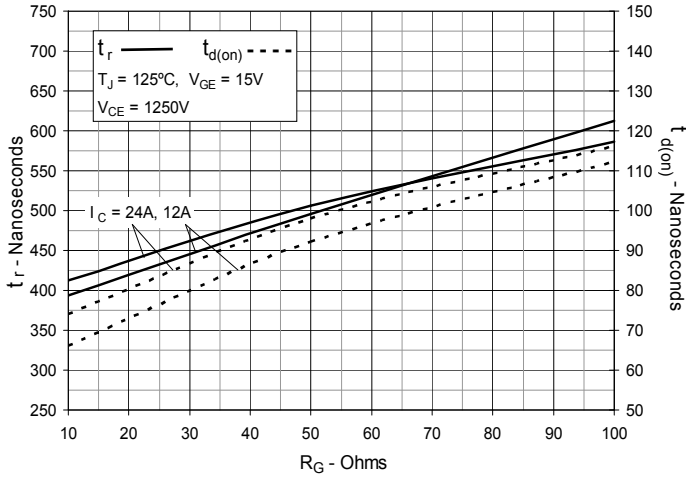
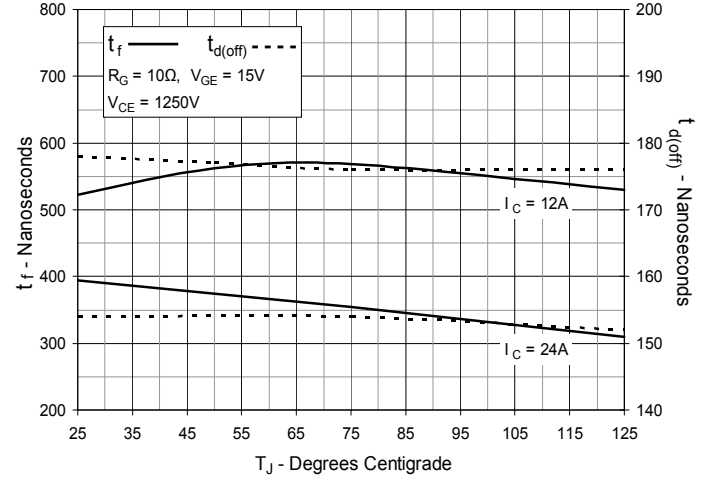
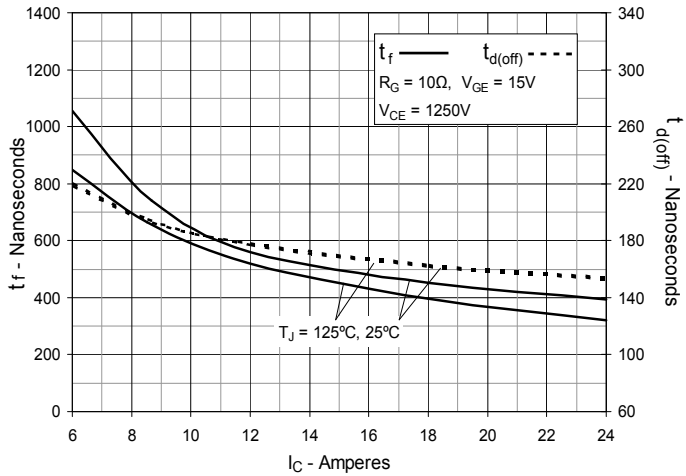
Fig. 12. Maximum Transient Thermal Impedance

Fig. 13. Resistive Turn-on Rise Time vs. Junction Temperature

Fig. 14. Resistive Turn-on Rise Time vs. Collector Current

Fig. 15. Resistive Turn-on Switching Times vs. Gate Resistance

Fig. 16. Resistive Turn-off Switching Times vs. Junction Temperature

Fig. 17. Resistive Turn-off Switching Times vs. Collector Current

Fig. 18. Resistive Turn-off Switching Times vs. Gate Resistance
