

NESG7030M04

Data Sheet

R09DS0037EJ0100
 Rev.1.00
 Apr 18, 2012

NPN Silicon Germanium Carbon RF Transistor

FEATURES

- The device is an ideal choice for low noise, high gain amplification.
 $NF = 0.75 \text{ dB TYP. @ } V_{CE} = 2 \text{ V, } I_C = 5 \text{ mA, } f = 5.8 \text{ GHz}$
 $G_a = 14 \text{ dB TYP. @ } V_{CE} = 2 \text{ V, } I_C = 5 \text{ mA, } f = 5.8 \text{ GHz}$
- $P_{O(1 \text{ dB})} = 4.5 \text{ dBm TYP. @ } V_{CE} = 2 \text{ V, } I_{C(\text{set})} = 10 \text{ mA, } f = 2 \text{ GHz}$
- Maximum stable power gain: $MSG = 16.5 \text{ dB TYP. @ } V_{CE} = 2 \text{ V, } I_C = 15 \text{ mA, } f = 5.8 \text{ GHz}$
- SiGe: C HBT technology
- This product is improvement of ESD.
- Flat-lead 4-pin thin-type super minimold (M04 PKG)

OUTLINE

RENESAS Package code : M04
 (Package name : Flat-lead 4-pin thin-type super minimold (M04 PKG))

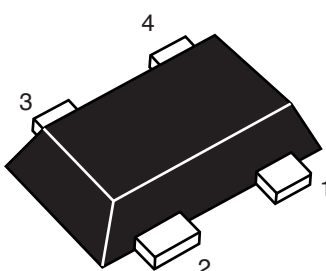

Note : Marking is "T1R."

1. Emitter
2. Collector
3. Emitter
4. Base

ORDERING INFORMATION

Part Number	Order Number	Package	Quantity	Supplying Form
NESG7030M04	NESG7030M04-A	Flat-lead 4-pin thin-type super minimold (M04 PKG) (Pb-Free)	50 pcs (Non reel)	• 8 mm wide embossed taping • Pin 1(Emitter), Pin 2 (Collector) face the perforation side of the tape
NESG7030M04-T2	NESG7030M04-T2-A		3 kpcs/reel	
NESG7030M04-T2B	NESG7030M04-T2B-A		15kpcs/reel	

Remark To order evaluation samples, please contact your nearby sales office.
 Unit sample quantity is 50 pcs.

CAUTION

Observe precautions when handling because these devices are sensitive to electrostatic discharge.

ABSOLUTE MAXIMUM RATINGS (T_A = +25°C)

Parameter	Symbol	Ratings	Unit
Collector to Base Voltage	V _{CBO}	10	V
Collector to Emitter Voltage	V _{CEO}	4.3	V
Base Current	I _B ^{Note1}	2	mA
Collector Current	I _C	30	mA
Total Power Dissipation	P _{tot} ^{Note2}	125	mW
Junction Temperature	T _j	150	°C
Storage Temperature	T _{stg}	-65 to +150	°C

- Notes: 1. Depend on the ESD protect device.
 2. Mounted on 1.08 cm² × 1.0 mm (t) glass epoxy PWB

ELECTRICAL CHARACTERISTICS (T_A = +25°C)

Parameter	Symbol	Test Conditions	MIN.	TYP.	MAX.	Unit
DC Characteristics						
Collector Cut-off Current	I _{CBO}	V _{CB} = 4.3 V, I _E = 0	-	-	100	nA
Emitter Cut-off Current	I _{EBO}	V _{EB} = 0.4 V, I _C = 0	-	-	100	nA
DC Current Gain	h _{FE} ^{Note 1}	V _{CE} = 2 V, I _C = 5 mA	200	320	500	-
RF Characteristics						
Reverse Transfer Capacitance	C _{re} ^{Note 2}	V _{CB} = 2 V, I _E = 0, f = 1 MHz	-	50	80	fF
Insertion Power Gain	S _{21e} ²	V _{CE} = 2 V, I _C = 15 mA, f = 5.8 GHz	11.0	13.0	-	dB
Maximum Stable Power Gain	MSG ^{Note 3}	V _{CE} = 2 V, I _C = 15 mA, f = 5.8 GHz	-	16.5	-	dB
Noise Figure (1)	NF1	V _{CE} = 2 V, I _C = 5 mA, f = 2 GHz, Z _S = Z _{Sopt} , Z _L = Z _{Lopt}	-	0.5	-	dB
Associated Gain (1)	G _{a1}	V _{CE} = 2 V, I _C = 5 mA, f = 2 GHz, Z _S = Z _{Sopt} , Z _L = Z _{Lopt}	-	21.0	-	dB
Noise Figure (2)	NF2	V _{CE} = 2 V, I _C = 5 mA, f = 5.8 GHz, Z _S = Z _{Sopt} , Z _L = Z _{Lopt}	-	0.75	1.15	dB
Associated Gain (2)	G _{a2}	V _{CE} = 2 V, I _C = 5 mA, f = 5.8 GHz, Z _S = Z _{Sopt} , Z _L = Z _{Lopt}	12.0	14.0	-	dB
Gain 1 dB Compression Output Power	P _{O(1 dB)}	V _{CE} = 2 V, I _{C(set)} = 10 mA, f = 2 GHz, Z _S = Z _{Sopt} , Z _L = Z _{Lopt}	-	4.5	-	dBm

- Notes: 1. Pulse measurement: PW ≤ 350 μs, Duty Cycle ≤ 2%
 2. Collector to base capacitance when the emitter grounded.
 3. $MSG = \left| \frac{S_{21}}{S_{12}} \right|$

h_{FE} CLASSIFICATION

Rank	YFB
Marking	T1R
h _{FE} Value	200 to 500

TYPICAL CHARACTERISTICS ($T_A = +25^\circ\text{C}$, unless otherwise specified)

TOTAL POWER DISSIPATION vs. AMBIENT TEMPERATURE

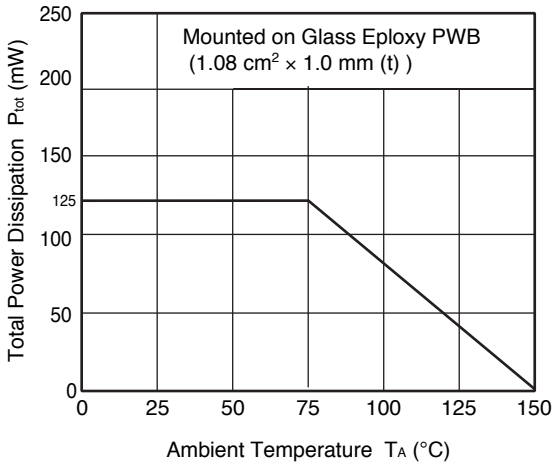

REVERSE TRANSFER CAPACITANCE vs. COLLECTOR TO BASE VOLTAGE

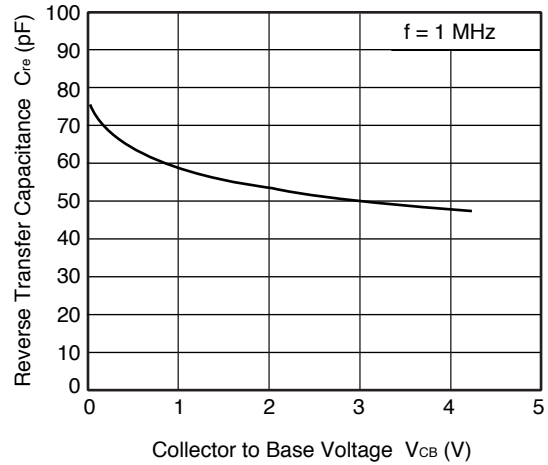

COLLECTOR CURRENT vs. BASE TO EMITTER VOLTAGE

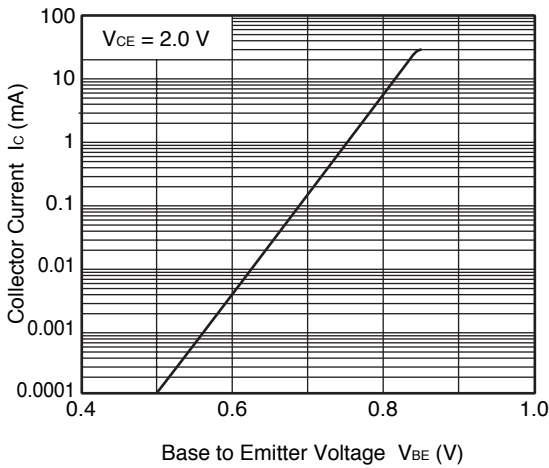

COLLECTOR CURRENT vs. COLLECTOR TO EMITTER VOLTAGE

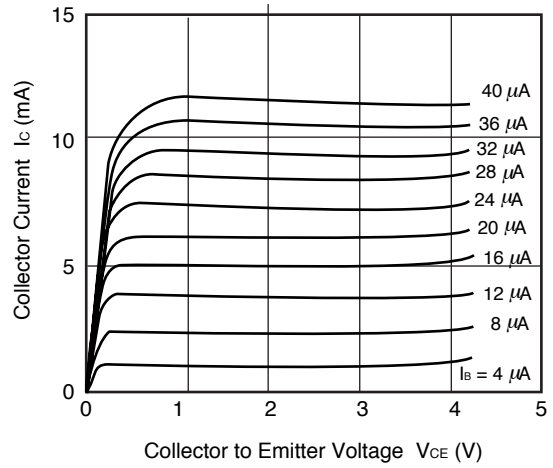

DC CURRENT GAIN vs. COLLECTOR CURRENT

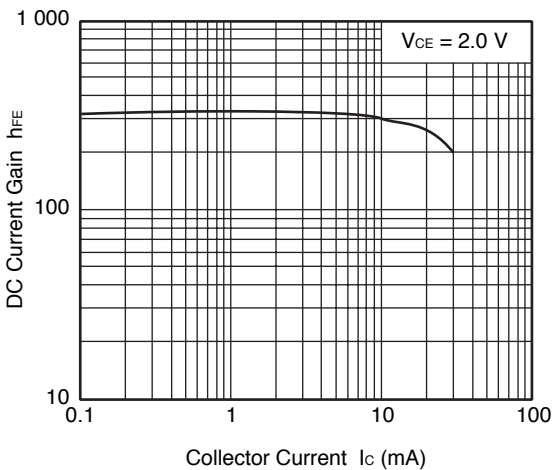

Remark The graph indicates nominal characteristics.

GAIN BANDWIDTH PRODUCT vs. COLLECTOR CURRENT

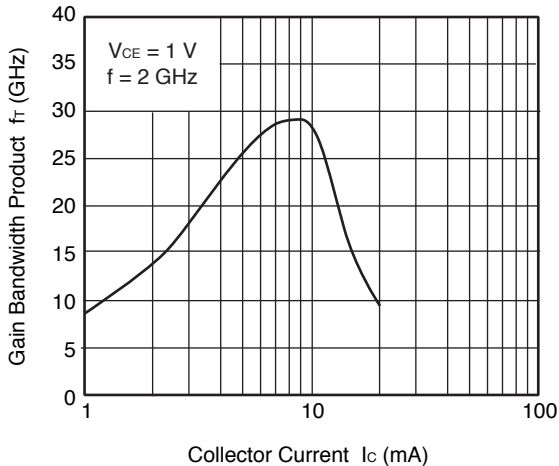

GAIN BANDWIDTH PRODUCT vs. COLLECTOR CURRENT

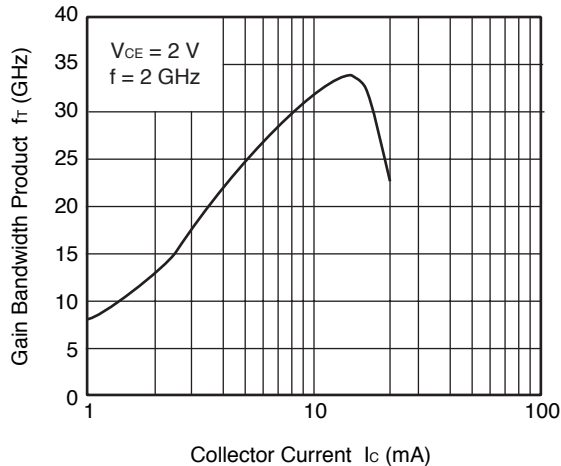

GAIN BANDWIDTH PRODUCT vs. COLLECTOR CURRENT

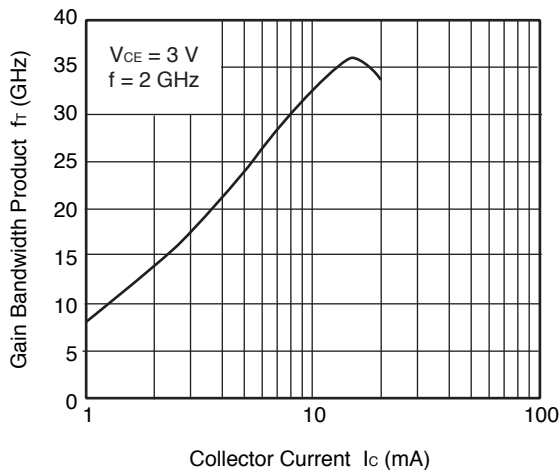

INSERTION POWER GAIN, MAG, MSG vs. FREQUENCY

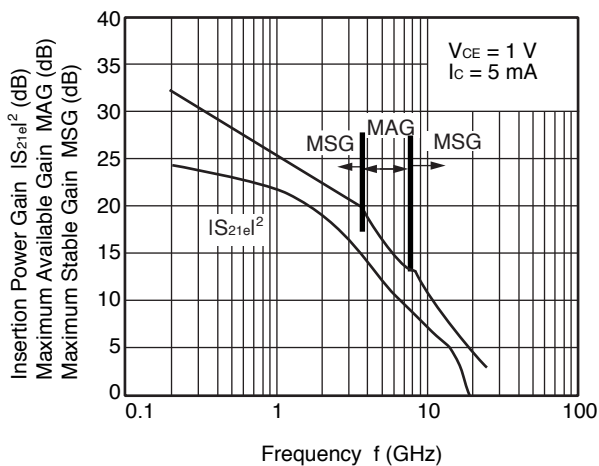

INSERTION POWER GAIN, MAG, MSG vs. FREQUENCY

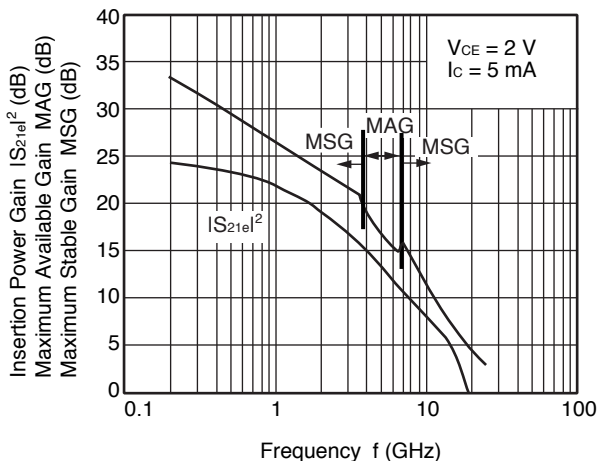

INSERTION POWER GAIN, MAG, MSG vs. FREQUENCY

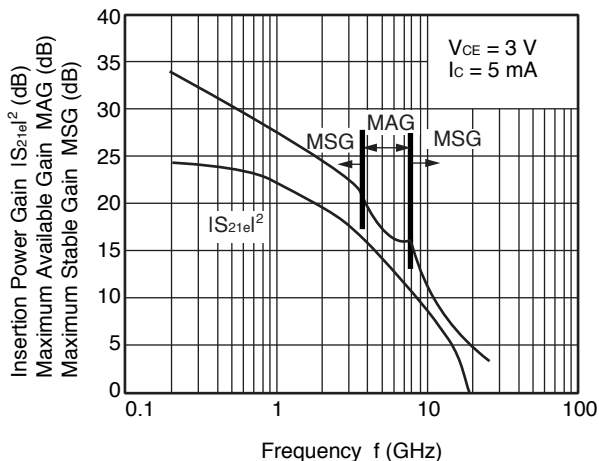

Remark The graph indicates nominal characteristics.

INSERTION POWER GAIN,
MAG, MSG vs. FREQUENCY

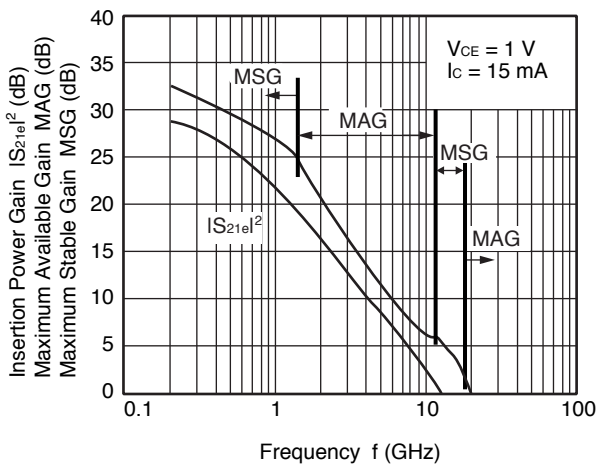

INSERTION POWER GAIN,
MAG, MSG vs. FREQUENCY

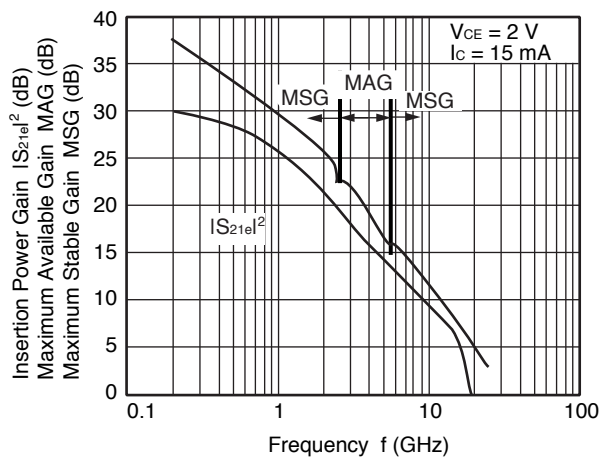

INSERTION POWER GAIN,
MAG, MSG vs. FREQUENCY

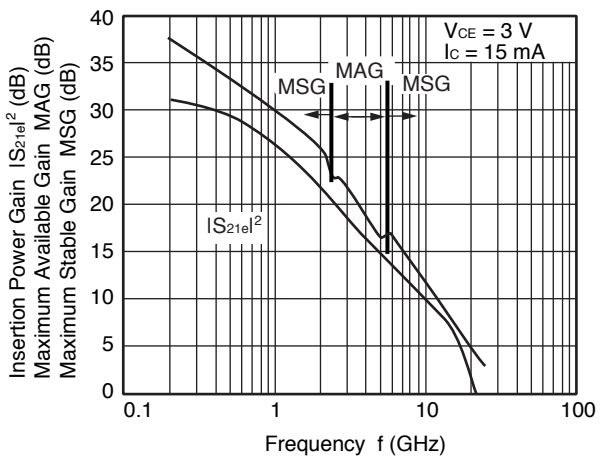

Remark The graph indicates nominal characteristics.

INSERTION POWER GAIN, MAG, MSG vs. COLLECTOR CURRENT

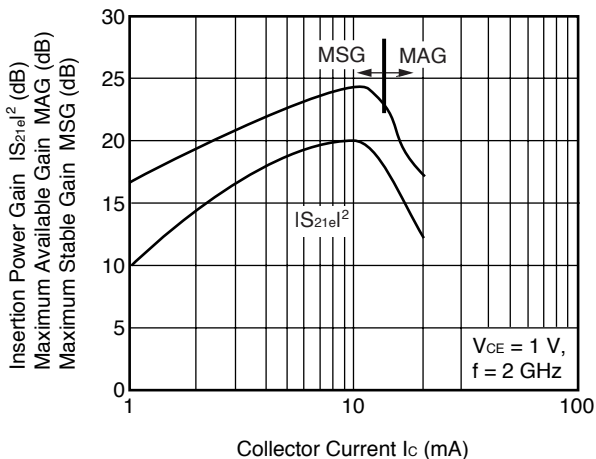

INSERTION POWER GAIN, MAG vs. COLLECTOR CURRENT

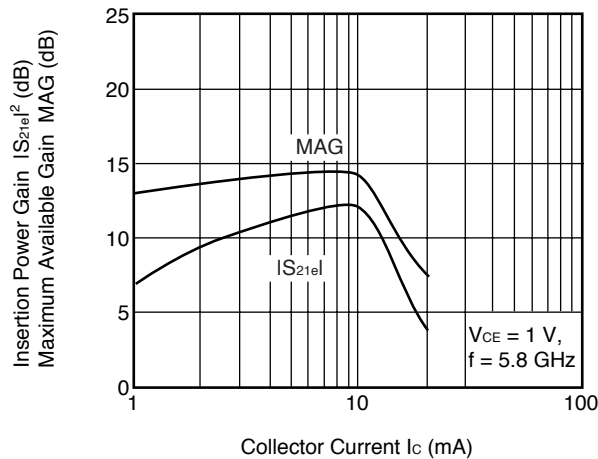

INSERTION POWER GAIN, MAG, MSG vs. COLLECTOR CURRENT

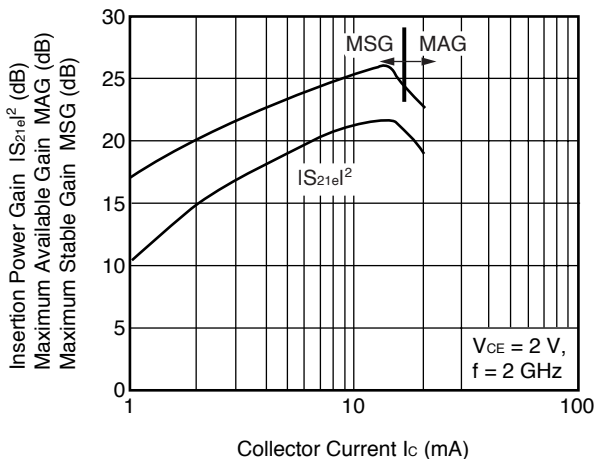

INSERTION POWER GAIN, MAG vs. COLLECTOR CURRENT

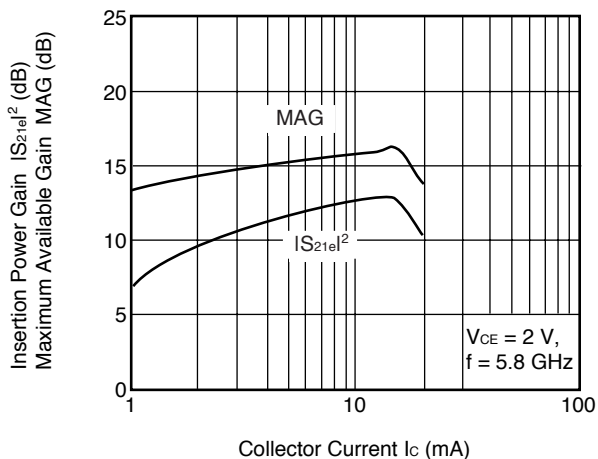

INSERTION POWER GAIN, MAG, MSG vs. COLLECTOR CURRENT

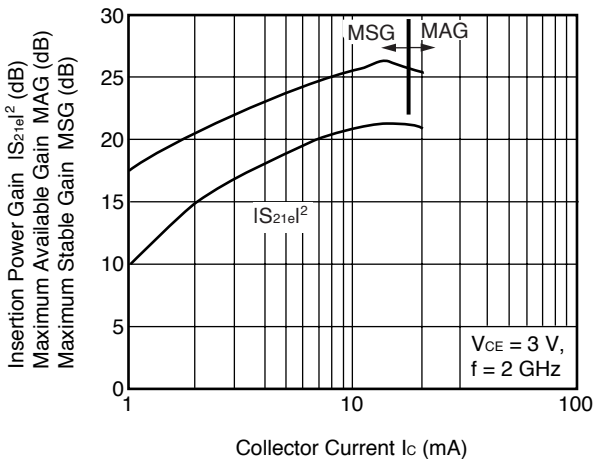

INSERTION POWER GAIN, MAG, MSG vs. COLLECTOR CURRENT

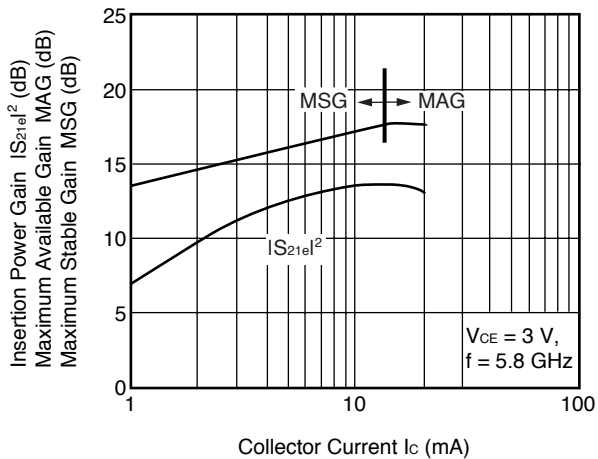

Remark The graph indicates nominal characteristics.

NOISE FIGURE, ASSOCIATED GAIN vs. COLLECTOR CURRENT

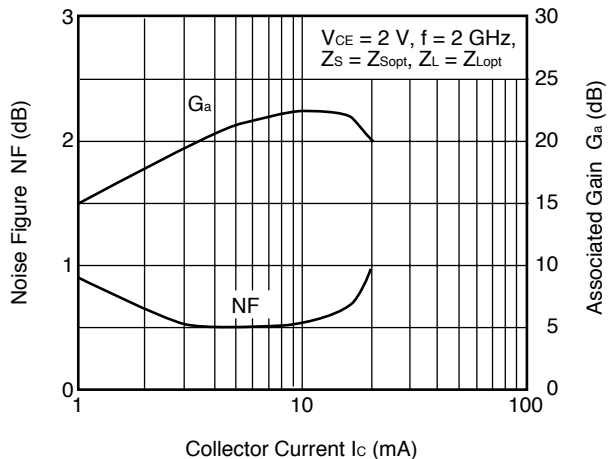

NOISE FIGURE, ASSOCIATED GAIN vs. COLLECTOR CURRENT

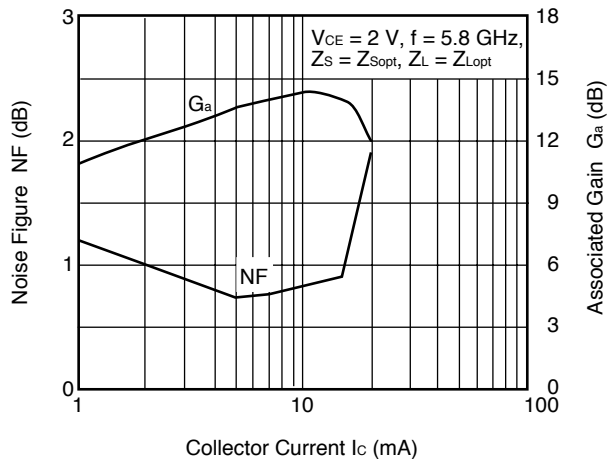

OUTPUT POWER, COLLECTOR CURRENT vs. INPUT POWER

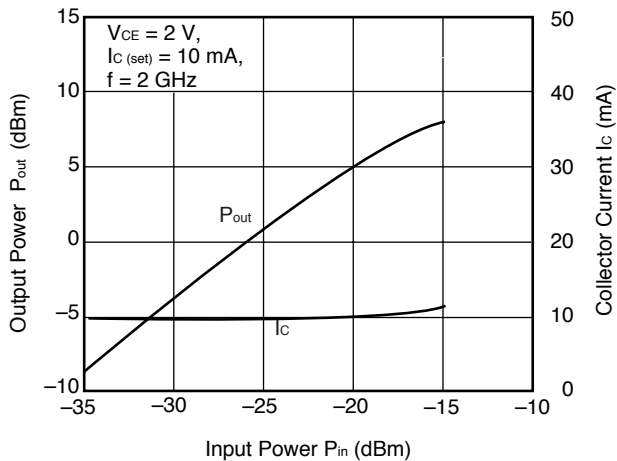

OUTPUT POWER, COLLECTOR CURRENT vs. INPUT POWER

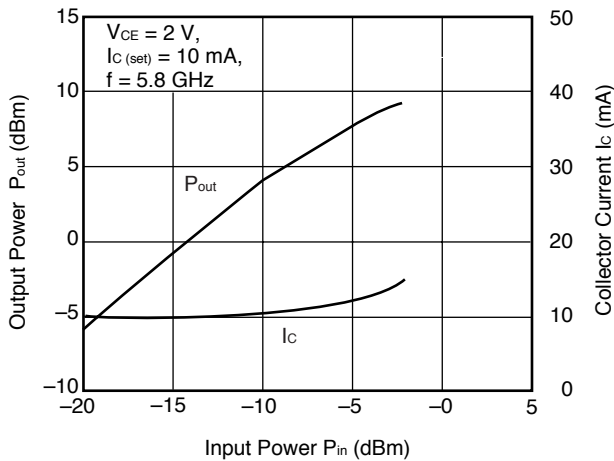

Remark The graph indicates nominal characteristics.

S-PARAMETERS

S-parameters and noise parameters are provided on our web site in a form (S2P) that enables direct import to microwave circuit simulators without keyboard inputs.

Click here to download S-parameters.

[Products] → [RF Devices] → [Device Parameters]

URL <http://www.renesas.com/products/microwave/download/parameter/>

PACKAGE DIMENSIONS

FLAT-LEAD 4-PIN THIN-TYPE SUPER MINIMOLD (M04 PKG) (UNIT: mm)

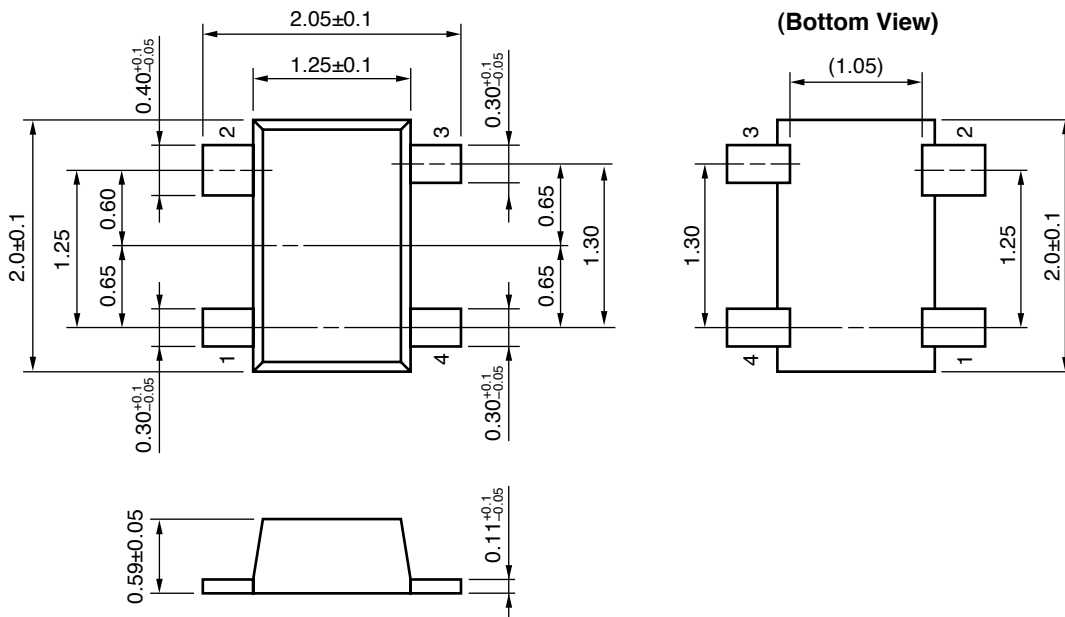

PIN CONNECTIONS

- 1. Emitter
- 2. Collector
- 3. Emitter
- 4. Base

Revision History	NESG7030M04 Data Sheet
-------------------------	-------------------------------

Rev.	Date	Description	
		Page	Summary
1.00	Apr 18, 2012	–	First edition issued

All trademarks and registered trademarks are the property of their respective owners.