



PART NAME

# SNAP UTILITY BOX

PART No.

CU-18423-B CU-18423-W

REVISION DATE

10-7-14

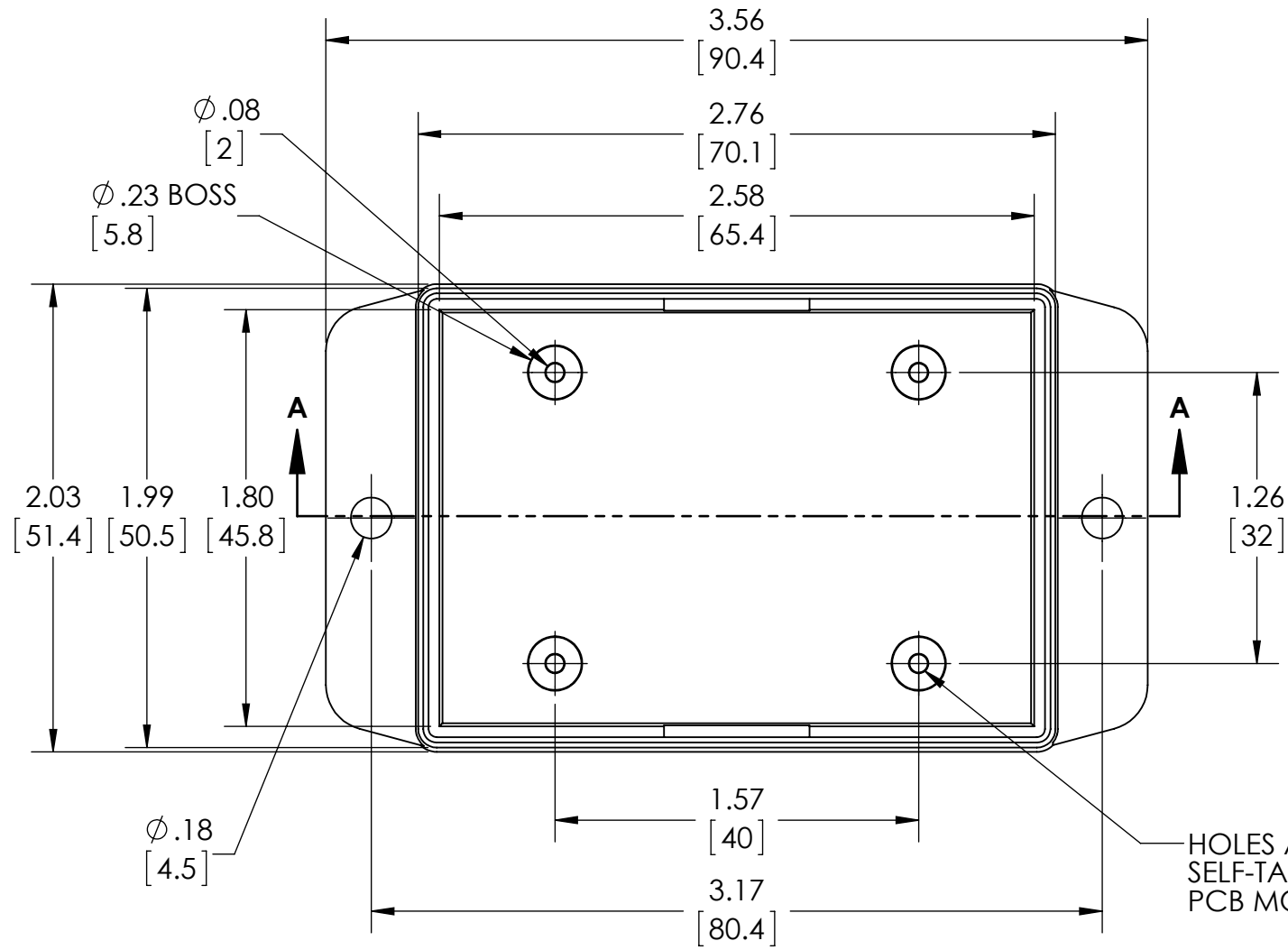

Holes accept M2.6 x 6mm LG. SELF-TAPPING SCREWS FOR PCB MOUNTING

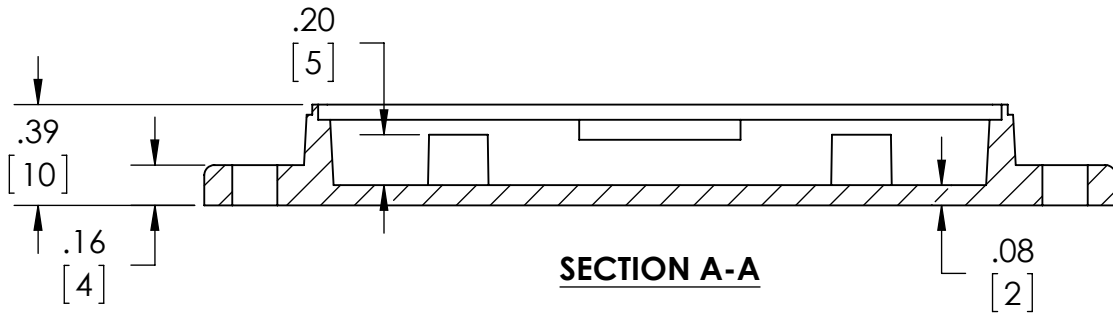
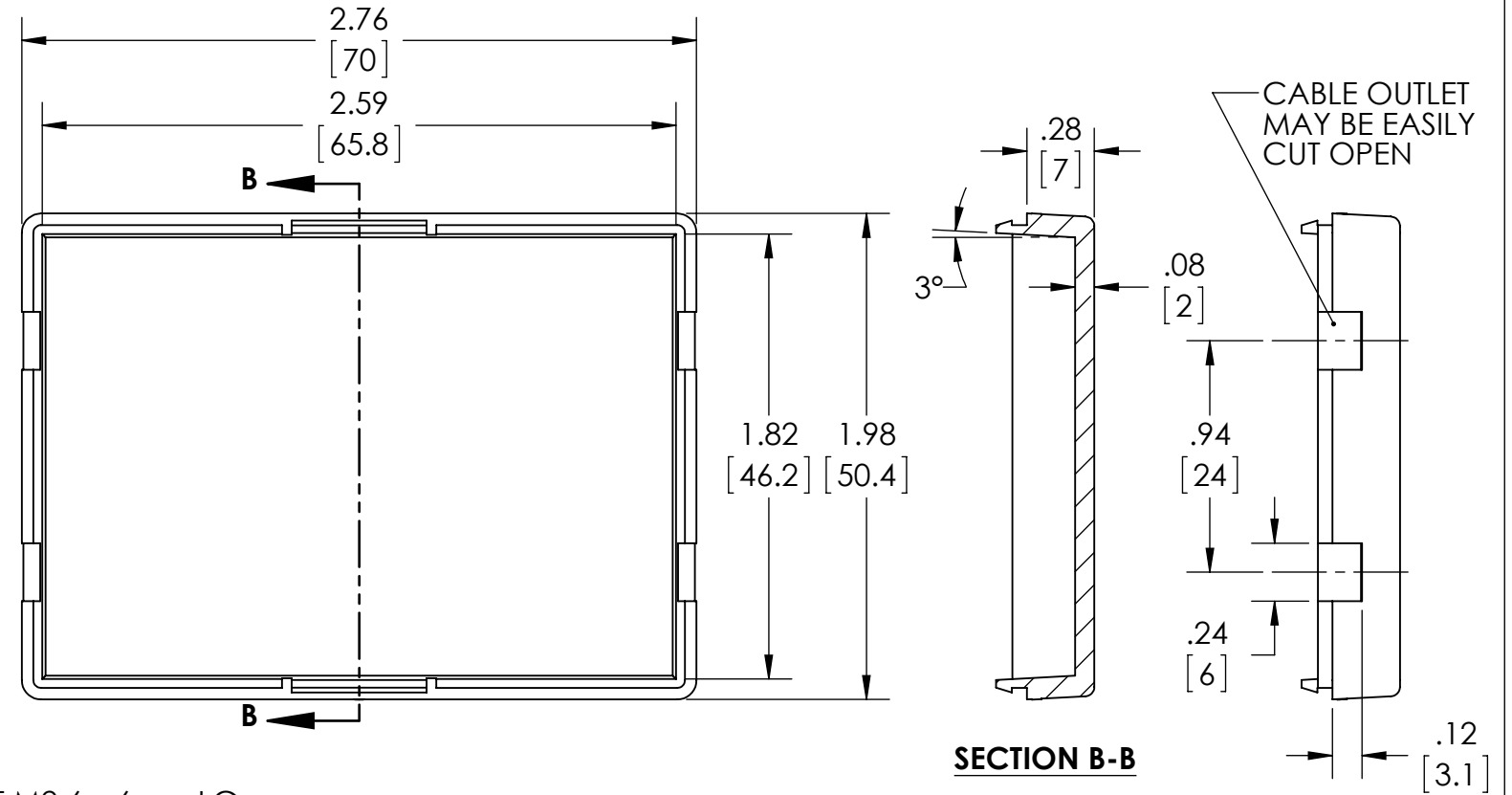

SECTION A-A

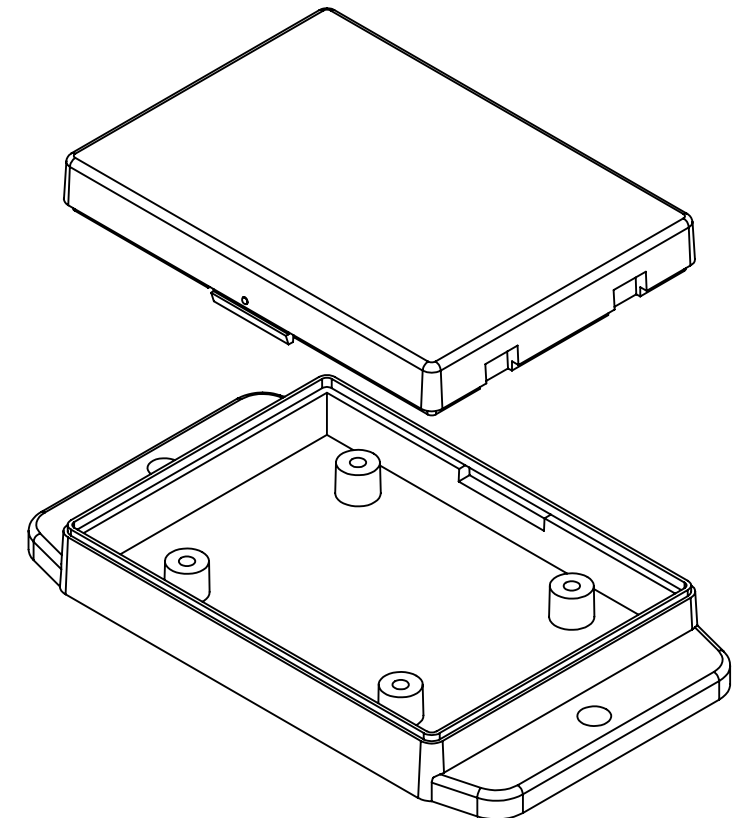

MATERIAL:  
ABS UL94-HB

COLOR:  
BLACK OR WHITE

DIMENSIONS IN INCH[MM]

DRAWING FOR REFERENCE

