

Sensor/actuator box - SACB-4/ 3-L- 5,0PUR M5 - 1530663

Please be informed that the data shown in this PDF Document is generated from our Online Catalog. Please find the complete data in the user's documentation. Our General Terms of Use for Downloads are valid (<http://download.phoenixcontact.com>)



Sensor/actuator box, Connection method: M5 socket Metal, Number of slots: 4, Number of positions: 3, Slot assignment: Single, Status indication: Yes, pnp; Master cable connection: Fixed connection 180°, PUR/PVC, Cable length: 5 m, Shielding: No

Product Features

- ✓ Safety in the field, thanks to molded housing and high degree of protection
- ✓ Flexible, distributed bundling of signals in one master cable
- ✓ Convenient: increased machine availability thanks to quick and easy diagnostics



Key commercial data

Packing unit	1 PCE
Weight per Piece (excluding packing)	272.6 GRM
Custom tariff number	85444290
Country of origin	Germany

Technical data

General

Rated voltage	24 V DC
Max. operating voltage U_{max}	30 V DC
Current carrying capacity per I/O signal	1 A
Current carrying capacity per slot	1 A
Total rated current	3 A
Number of positions	3
Number of slots	4
Inflammability class according to UL 94	V0
Sensor/actuator connection system	M5 socket

Ambient conditions

Degree of protection	IP67
----------------------	------

Sensor/actuator box - SACB-4/ 3-L- 5,0PUR M5 - 1530663

Technical data

Ambient conditions

Ambient temperature (operation)	-25 °C ... 80 °C
	-30 °C ... 70 °C (cable, fixed installation)
	-5 °C ... 70 °C (cable, flexible installation)

Local diagnostics function

Local diagnostics	Supply voltage Green LED
	Status display I/O Yellow LED

Master cable data/connection data

Connection method	Fixed connection
Length of cable	5 m
Cable type	Master cable suitable for flexible cable conduit
Signal line cross section	8x 0.25 mm ²
Power supply cross section	2x 0.5 mm ²
External diameter	6 mm
Max. bending cycles	1000000

Insulation material

Housing material	PA-GF
Contact material	CuZn
Contact surface material	Ni/Au
Material of threaded sleeve	Cu alloy
Material of threaded sleeve surface	Nickel-plated

Pin assignment

Slot/position = Wire color or connection	1 / 4 (A) = WH
	2 / 4 (A) = GN
	3 / 4 (A) = YE
	4 / 4 (A) = GY
	1-4 / 1 (+ 24 V) = BN
	1-4 / 3 (0 V) = BU

Classifications

eCl@ss

eCl@ss 4.0	27140815
eCl@ss 4.1	27140815
eCl@ss 5.0	27143423
eCl@ss 5.1	27143423

Sensor/actuator box - SACB-4/ 3-L- 5,0PUR M5 - 1530663

Classifications

eCl@ss

eCl@ss 6.0	27143423
eCl@ss 7.0	27449001
eCl@ss 8.0	27449001

ETIM

ETIM 2.0	EC000200
ETIM 3.0	EC001856
ETIM 4.0	EC002585
ETIM 5.0	EC002585

UNSPSC

UNSPSC 6.01	31261501
UNSPSC 7.0901	31261501
UNSPSC 11	31261501
UNSPSC 12.01	31261501
UNSPSC 13.2	31261501

Approvals

Approvals

Approvals

GOST

Ex Approvals

Approvals submitted

Approval details

GOST 
--

Accessories

Accessories

Sensor/actuator box - SACB-4/ 3-L- 5,0PUR M5 - 1530663

Accessories

Protective cap

Screw plug - PROT-M5 - 1533288



An M5 screw plug for the unoccupied M5 sockets of the sensor/actuator cable, boxes and flush-type connectors

Drawings

Schematic diagram

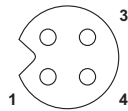

M5 slot, socket, 3-pos.

Dimensioned drawing

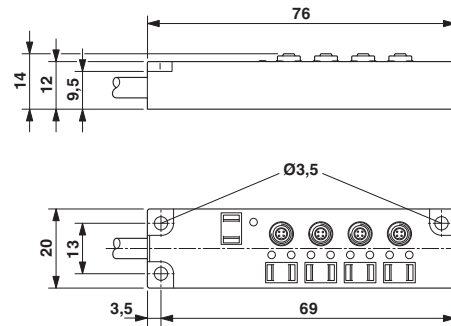

Circuit diagram

