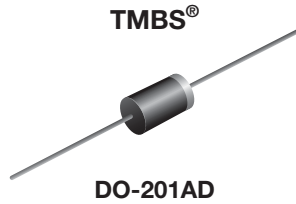

# Photovoltaic Solar Cell Protection Schottky Rectifier

 Ultra Low  $V_F = 0.30\text{ V}$  at  $I_F = 5\text{ A}$ 

## FEATURES

- Trench MOS Schottky technology
- Low forward voltage drop, low power losses
- High efficiency operation
- High forward surge capability
- Solder dip 275 °C max. 10 s, per JESD 22-B106
- Material categorization: For definitions of compliance please see [www.vishay.com/doc?99912](http://www.vishay.com/doc?99912)

**RoHS**  
COMPLIANT

## TYPICAL APPLICATIONS

For use in solar cell junction box as a bypass diode for protection, using DC forward current without reverse bias.

## MECHANICAL DATA

**Case:** DO-201AD

Molding compound meets UL 94 V-0 flammability rating  
Base P/N-E3 - RoHS-compliant, commercial grade

**Terminals:** Matte tin plated leads, solderable per J-STD-002 and JESD 22-B102

E3 suffix meets JESD 201 class 1A whisker test

**Polarity:** Color band denotes cathode end

PRIMARY CHARACTERISTICS	
$I_{F(AV)}$	15 A
$V_{RRM}$	45 V
$I_{FSM}$	200 A
$V_F$ at $I_F = 15\text{ A}$	0.38 V
$T_{OP}$ max. (AC mode)	150 °C
$T_J$ max. (DC forward current)	200 °C
Package	DO-201AD
Diode variations	Single die

MAXIMUM RATINGS ( $T_A = 25\text{ °C}$ unless otherwise noted)			
PARAMETER	SYMBOL	VSB1545S	UNIT
Device marking code		V1545S	
Maximum repetitive peak reverse voltage	$V_{RRM}$	45	V
Maximum DC forward current (fig. 1, 2)	$I_{F(DC)}^{(1)}$	15	A
	$I_{F(DC)}^{(2)}$	7.0	
Peak forward surge current 8.3 ms single half sine-wave superimposed on rated load	$I_{FSM}$	200	A
Operating junction temperature range (AC mode)	$T_{OP}$	-40 to +150	°C
Junction temperature in DC forward current without reverse bias, $t \leq 1\text{ h}$	$T_J^{(3)}$	$\leq 200$	

### Notes

- (1) With heatsink
- (2) Without heatsink, free air
- (3) Meets the requirements of IEC 61215 ed. 2 bypass diode thermal test



ELECTRICAL CHARACTERISTICS (T <sub>A</sub> = 25 °C unless otherwise noted)						
PARAMETER	TEST CONDITIONS	SYMBOL	TYP.	MAX.	UNIT	
Instantaneous forward voltage	I <sub>F</sub> = 5.0 A	T <sub>A</sub> = 25 °C	V <sub>F</sub> <sup>(1)</sup>	0.42	-	V
	I <sub>F</sub> = 7.5 A			0.44	-	
	I <sub>F</sub> = 15 A			0.48	0.59	
	I <sub>F</sub> = 5.0 A	T <sub>A</sub> = 125 °C		0.30	-	
	I <sub>F</sub> = 7.5 A			0.33	-	
	I <sub>F</sub> = 15 A			0.38	0.46	
Reverse current	V <sub>R</sub> = 45 V	T <sub>A</sub> = 25 °C	I <sub>R</sub> <sup>(2)</sup>	-	1000	μA
		T <sub>A</sub> = 125 °C		13.8	30	mA
Typical junction capacitance	4.0 V, 1 MHz	C <sub>J</sub>	1995	-	pF	

**Notes**

- (1) Pulse test: 300 μs pulse width, 1 % duty cycle
- (2) Pulse test: 40 ms pulse width

THERMAL CHARACTERISTICS (T <sub>A</sub> = 25 °C unless otherwise noted)			
PARAMETER	SYMBOL	VSB1545S	UNIT
Thermal resistance	R <sub>θJA</sub> <sup>(1)</sup>	45	°C/W
	R <sub>θJL</sub> <sup>(1)</sup>	9	
Typical thermal resistance	R <sub>θJL</sub> <sup>(2)</sup>	4	°C/W

**Notes**

- (1) Without heatsink, free air; units mounted on PCB with 2 mm x 2 mm copper pad areas at 9.5 mm lead length
- (2) Leads clipped at 3 mm lead length from plastic body on 7.0 cm x 2.2 cm x 1.9 cm x 2 heatsink

ORDERING INFORMATION (Example)				
PREFERRED P/N	UNIT WEIGHT (g)	PREFERRED PACKAGE CODE	BASE QUANTITY	DELIVERY MODE
VSB1545S-E3/54	1.20	54	1400	13" diameter paper tape and reel
VSB1545S-E3/73	1.20	73	1000	Ammo pack packaging

**RATINGS AND CHARACTERISTICS CURVES (T<sub>A</sub> = 25 °C unless otherwise noted)**

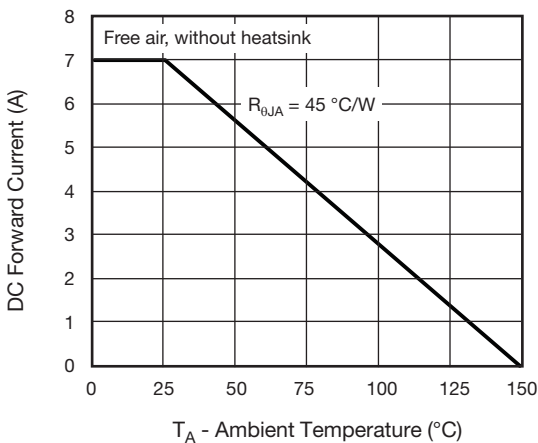

Fig. 1 - Forward Current Derating Curve

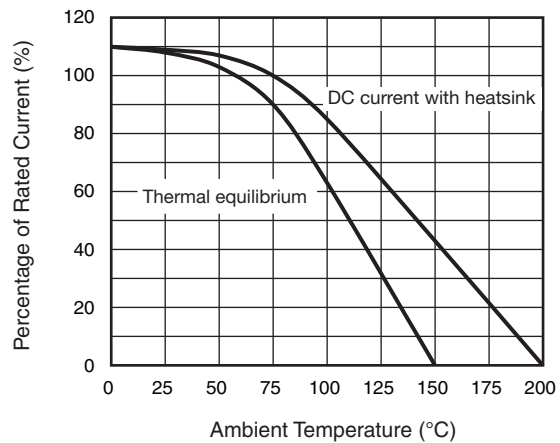

Fig. 2 - Rated Forward Current vs. Ambient Temperature

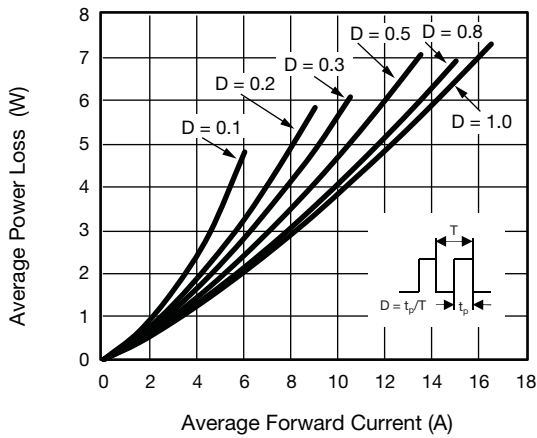

Fig. 3 - Forward Power Loss Characteristics

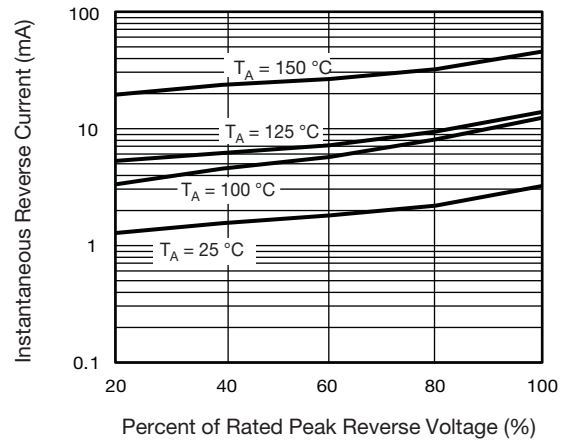

Fig. 5 - Typical Reverse Leakage Characteristics

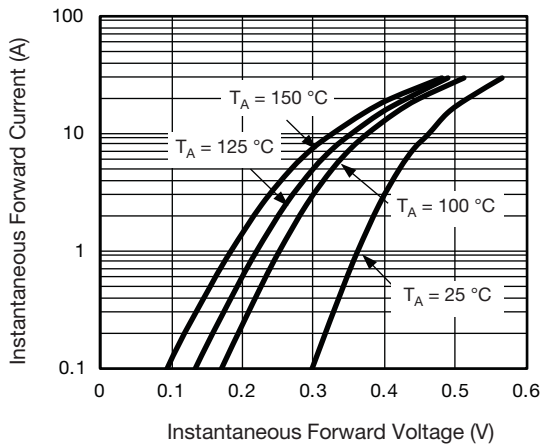

Fig. 4 - Typical Instantaneous Forward Characteristics

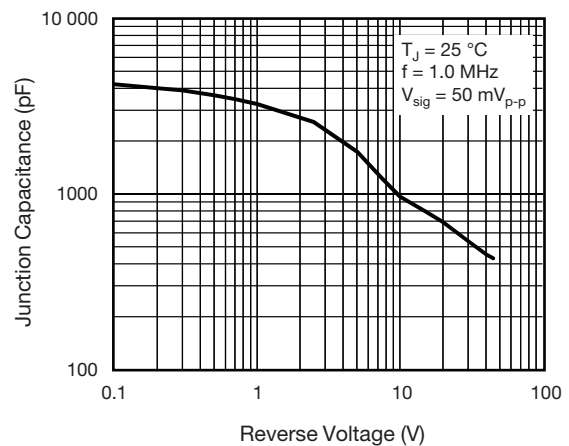
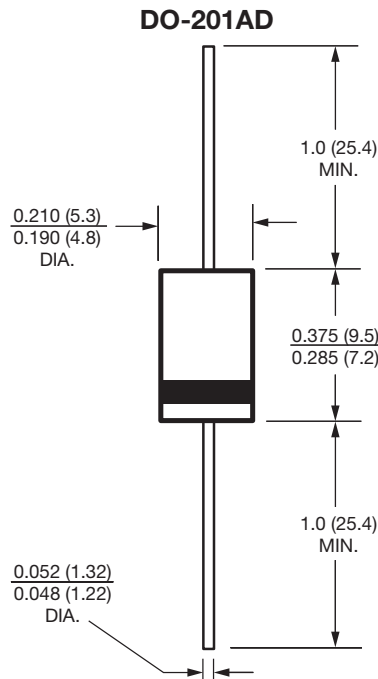

Fig. 6 - Typical Junction Capacitance

**PACKAGE OUTLINE DIMENSIONS** in inches (millimeters)





## **Disclaimer**

ALL PRODUCT, PRODUCT SPECIFICATIONS AND DATA ARE SUBJECT TO CHANGE WITHOUT NOTICE TO IMPROVE RELIABILITY, FUNCTION OR DESIGN OR OTHERWISE.

Vishay Intertechnology, Inc., its affiliates, agents, and employees, and all persons acting on its or their behalf (collectively, "Vishay"), disclaim any and all liability for any errors, inaccuracies or incompleteness contained in any datasheet or in any other disclosure relating to any product.

Vishay makes no warranty, representation or guarantee regarding the suitability of the products for any particular purpose or the continuing production of any product. To the maximum extent permitted by applicable law, Vishay disclaims (i) any and all liability arising out of the application or use of any product, (ii) any and all liability, including without limitation special, consequential or incidental damages, and (iii) any and all implied warranties, including warranties of fitness for particular purpose, non-infringement and merchantability.

Statements regarding the suitability of products for certain types of applications are based on Vishay's knowledge of typical requirements that are often placed on Vishay products in generic applications. Such statements are not binding statements about the suitability of products for a particular application. It is the customer's responsibility to validate that a particular product with the properties described in the product specification is suitable for use in a particular application. Parameters provided in datasheets and / or specifications may vary in different applications and performance may vary over time. All operating parameters, including typical parameters, must be validated for each customer application by the customer's technical experts. Product specifications do not expand or otherwise modify Vishay's terms and conditions of purchase, including but not limited to the warranty expressed therein.

Except as expressly indicated in writing, Vishay products are not designed for use in medical, life-saving, or life-sustaining applications or for any other application in which the failure of the Vishay product could result in personal injury or death. Customers using or selling Vishay products not expressly indicated for use in such applications do so at their own risk. Please contact authorized Vishay personnel to obtain written terms and conditions regarding products designed for such applications.

No license, express or implied, by estoppel or otherwise, to any intellectual property rights is granted by this document or by any conduct of Vishay. Product names and markings noted herein may be trademarks of their respective owners.