

LR2-O-90

~10° x 40° oval beam optimized for LUXEON Rebel ES. 14.8 mm high assembly with installation tape. Variant with beam direction rotated 90°.

TECHNICAL SPECIFICATIONS:

Dimensions	Ø 21.6 mm
Height	14.8 mm
Fastening	tape, pin
Colour	white
Box size	480 x 280 x 300 mm
Box weight	10 kg
Quantity in Box	1680 pcs
ROHS compliant	yes ⓘ



MATERIAL SPECIFICATIONS:

Component	Type	Material	Colour
LXP2-O-90	Lens	PMMA	clear
LR2-ES-LH1-HLD	Holder	PC	white
HEIDI-TAPE	Tape	PU tape	black

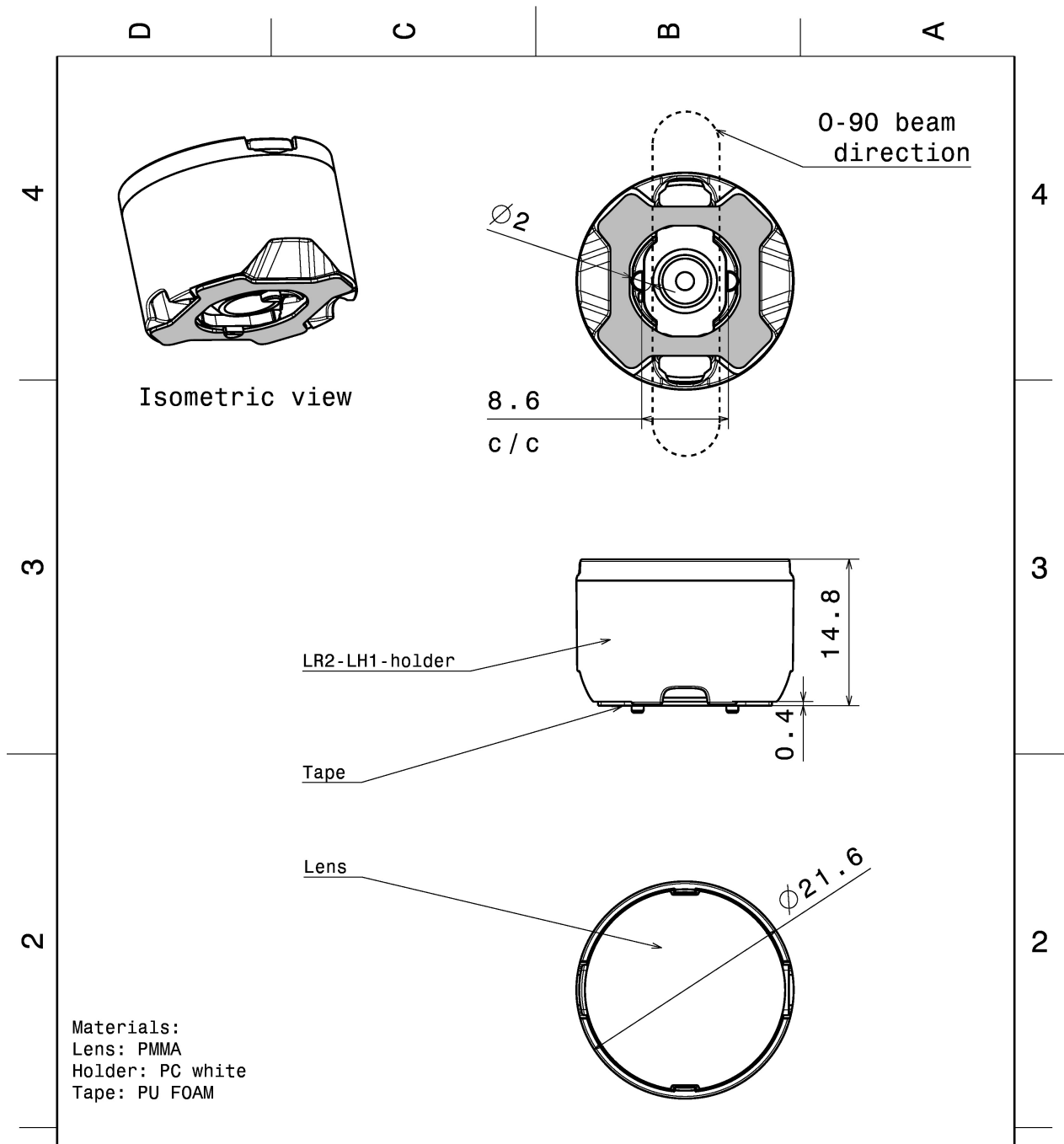

This drawing is our property. It can't be reproduced or communicated without our written agreement.		LEDiL		Ledil Oy Salorankatu 10 FIN-24100 SALO Finland	
DRAWING TITLE		Datasheet LR2-ES series			
DRAWN BY ah	DATE 27.1.2012	SIZE A4	DRAWING NUMBER		REV 3
CHECKED BY sn	DATE 27.1.2012	SCALE 1:1	WEIGHT (g)	SHEET 1/1	
DESIGNED BY pl	DATE 27.08.2010				

PHOTOMETRIC DATA (MEASURED):



LED XP-L
 FWHM 16.0 + 39.0°
 Efficiency 89 %
 Peak intensity 3.300 cd/lm
 Required components:

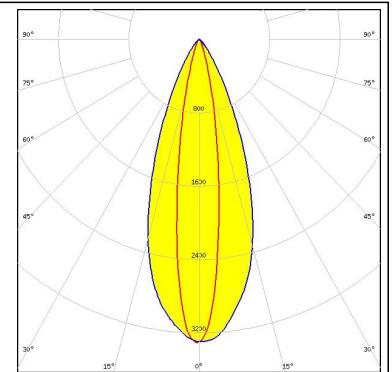

LED LUXEON Rebel ES
 FWHM 13.0 + 36.0°
 Efficiency 92 %
 Peak intensity 4.700 cd/lm
 Required components:

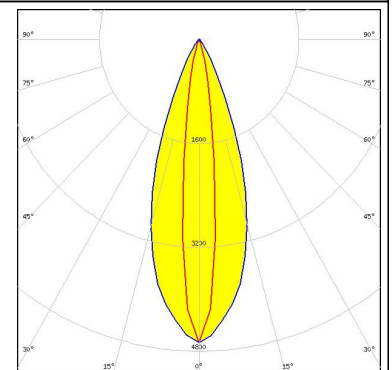
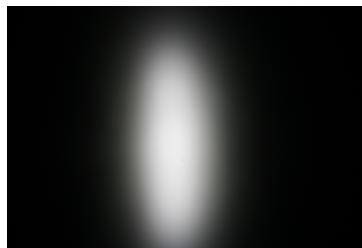

LED LUXEON T
 FWHM 14.0 + 39.0°
 Efficiency 88 %
 Peak intensity 4.100 cd/lm
 Required components:

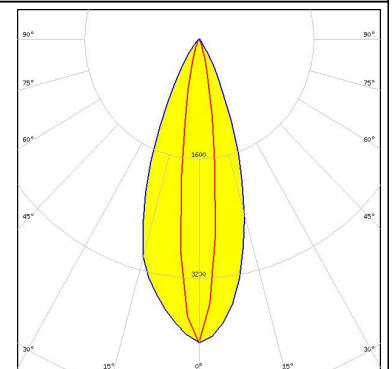

LED LUXEON TX
 FWHM 14.0 + 41.0°
 Efficiency 90 %
 Peak intensity 4.200 cd/lm
 Required components:

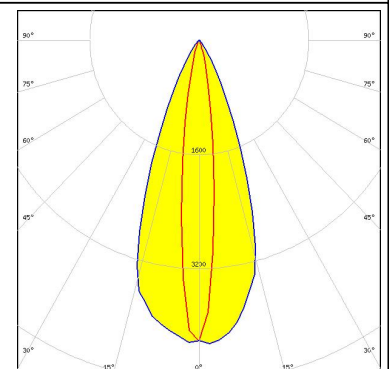
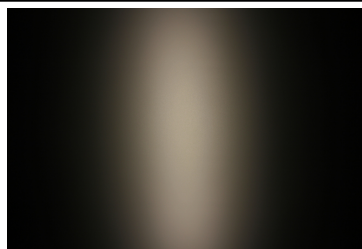

PHOTOMETRIC DATA (MEASURED):



LED LUXEON Z ES
FWHM 10.0 + 40.0°
Efficiency 89 %
Peak intensity 6.000 cd/lm
Required components:

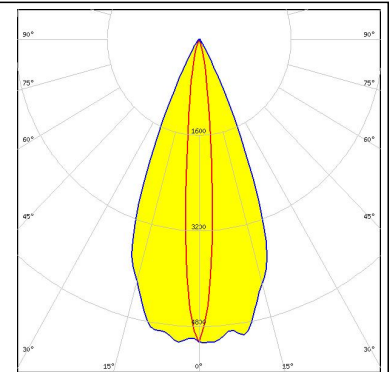
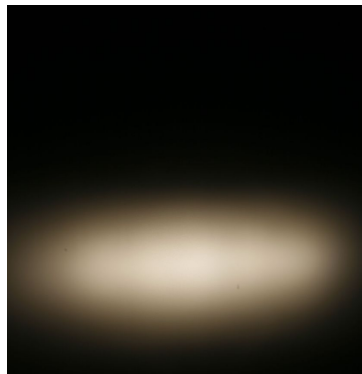

LED NVSxx19B/NVSxx19C
FWHM 13.0 + 43.0°
Efficiency 94 %
Peak intensity 4.100 cd/lm
Required components:

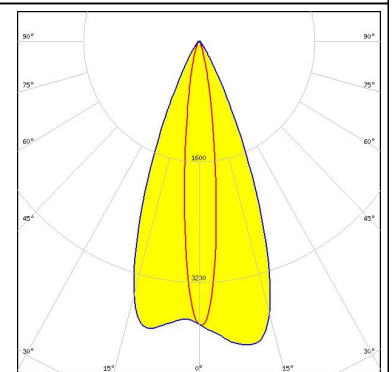
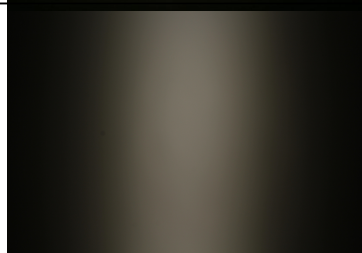

LED Oslon Square EC
FWHM 14.0 + 34.0°
Efficiency 88 %
Peak intensity 4.300 cd/lm
Required components:

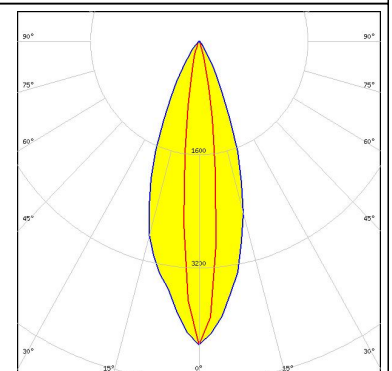
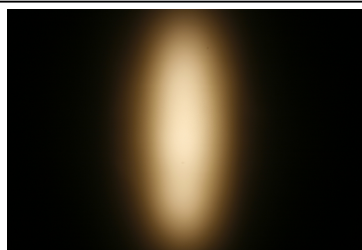

PHOTOMETRIC DATA (SIMULATED):



LED XP-G3
FWHM 15.0 + 41.0°
Efficiency 93 %
Peak intensity 3.800 cd/lm
Required components:

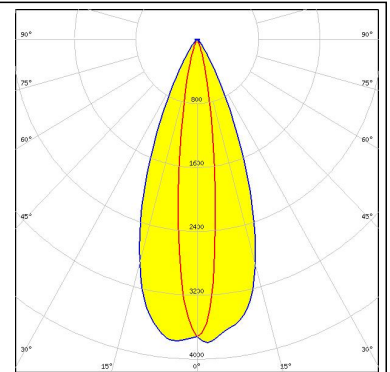

LED LUXEON C
FWHM 9.6 + 44.0°
Efficiency 94 %
Peak intensity 5.500 cd/lm
Required components:

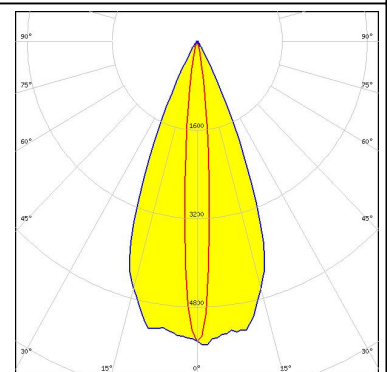

LED LUXEON Z
FWHM 9.0 + 45.0°
Efficiency 94 %
Peak intensity 5.700 cd/lm
Required components:

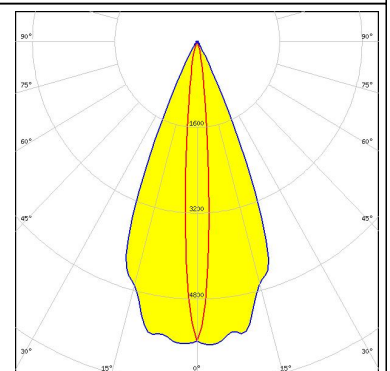

GENERAL INFORMATION:

NOTE: The typical beam angle will be changed by different color, chip size and chip position tolerance. The typical total beam angle is the full angle measured where the luminous intensity is half of the peak value.

MATERIALS:

As part of our continuous research and improvement processes, and to ensure the best possible quality and availability of our products, LEDiL reserves the right to change material grades without notice.

PRODUCT DATA USER AGREEMENT AND DISCLAIMER:

The measured data in the provided downloadable LEDiL Product Datasheets and Mechanical 2D-Drawings is rounded and provided as reference for planning. LEDiL Oy's optical specifications have been verified by conducting performance testing of the products in accordance with the company's quality system. The reported data are averaged results of multiple measurements with typical variation. LEDiL Oy reserves the right to without prior notification make changes and improvements to its products.

LEDiL Oy assumes neither warranty, nor guarantee nor any other liability of any kind for the contents and correctness of the provided data. The provided data has been generated with highest diligence but the provided data may in reality not represent the complete possible variation range of all intrinsic parameters. Therefore, in certain cases a deviation from the provided data could occur.

LEDiL Oy reserves the right to undertake technical changes of its products without further notification which could lead to changes in the provided data. LEDiL Oy assumes no liability of any kind for the possible deviation from any provided data or any other damage resulting from the usage of the provided data.

The user agrees to this disclaimer and user agreement with the download or usage of the provided files.

LEDiL Oy

Joensuunkatu 13
FI-24240 SALO
Finland

LEDiL Inc.

228 West Page Street
Suite D
Sycamore IL 60178
USA

Local sales and technical support

[www.ledil.com/
where_to_buy](http://www.ledil.com/where_to_buy)

Shipping locations

Salo, Finland
Hong Kong, China

Distribution Partners

[www.ledil.com/
where_to_buy](http://www.ledil.com/where_to_buy)