

TL3365 SERIES TACT SWITCH

ANTI-VANDAL SWITCHES
 DETECTOR SWITCHES
 DIP SWITCHES
 KEYLOCK SWITCHES
 NAVIGATION SWITCHES
 PUSHBUTTON SWITCHES
 ROCKER SWITCHES
 ROTARY SWITCHES
 SLIDE SWITCHES
 SNAP ACTION SWITCHES
TACTILE SWITCHES
 TOGGLE SWITCHES
 CAP OPTIONS



APPLICATIONS / MARKETS



Audio / Visual

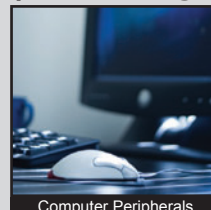

Computer Peripherals

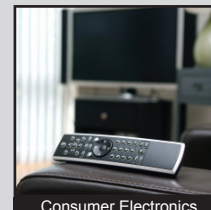

Consumer Electronics

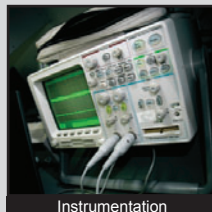

Instrumentation



Telecommunication



Medical Equipment

RoHS

SPECIFICATIONS

Electrical Rating: 50mA @ 12VDC
Electrical Life: 100,000 Cycles
Mechanical Life: 100,000 Cycles
Contact Resistance: 100mΩ Max. Initial
Insulation Resistance: 100M Ω at 100VDC
Dielectric Strength: 250VAC for 1 min.
Operating Temperature: -20°C to 70°C
Storage Temperature: -30°C to 80°C
Operating Force: 180 gf
Travel: 0.2mm
Contact Arrangement: SPST

FEATURES & BENEFITS

- Ultraminiature
- Surface mount

PART NUMBER CONFIGURATOR

Series	Model	Actuator Option	Actuation Force	Contact Material	Termination
<input type="text" value="TL"/>	<input type="text" value="3365"/>	<input type="text" value="A - 2.25mm"/>	<input type="text" value="F180 - 180 gf"/>	<input type="text" value="Q - Silver"/>	<input type="text" value="Q - Gullwing"/>

Specifications subject to change without notice



E-SWITCH®

www.e-switch.com

800.867.2717

2

TL3365 SERIES TACT SWITCH

BODY DIMENSIONS

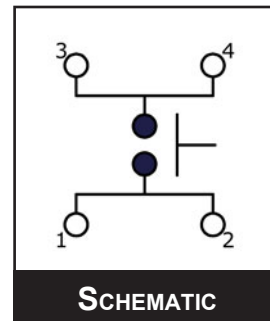
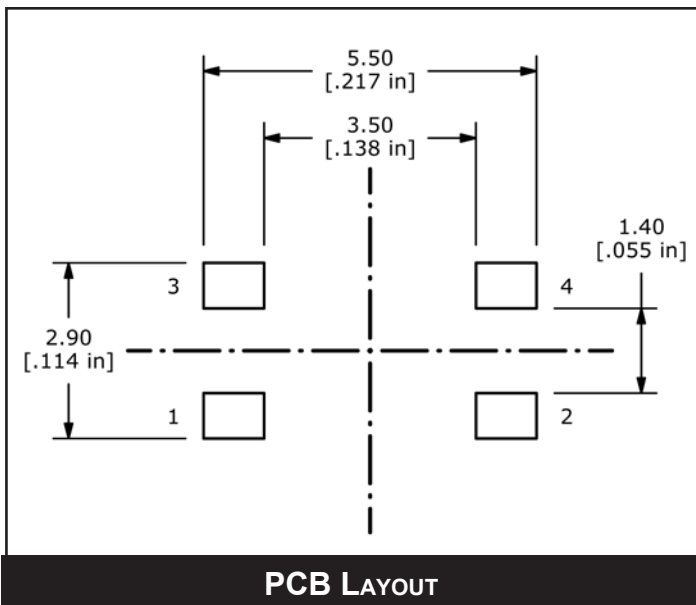
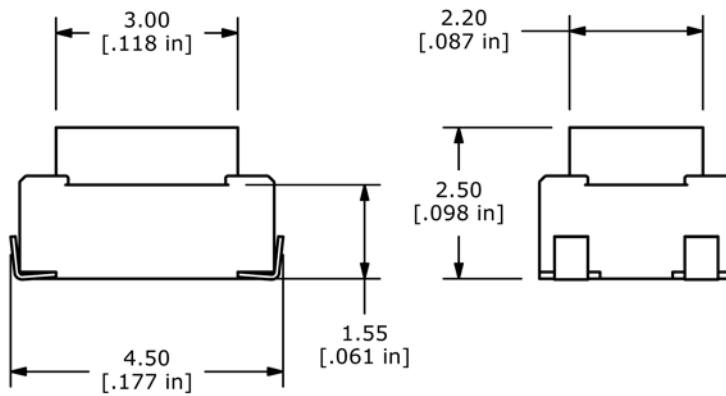
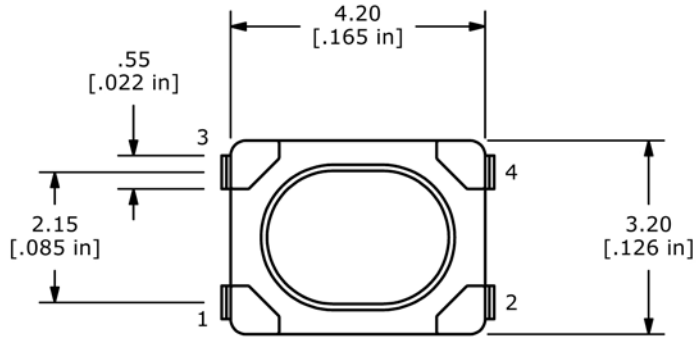

- ANTI-VANDAL SWITCHES
- DETECTOR SWITCHES
- DIP SWITCHES
- KEYLOCK SWITCHES
- NAVIGATION SWITCHES
- PUSHBUTTON SWITCHES
- ROCKER SWITCHES
- ROTARY SWITCHES
- SLIDE SWITCHES
- SNAP ACTION SWITCHES
- TACTILE SWITCHES**
- TOGGLE SWITCHES
- CAP OPTIONS

