

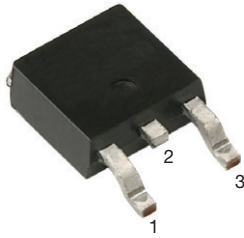

## Surface Mount Fast Soft Recovery Rectifier Diode, 8 A

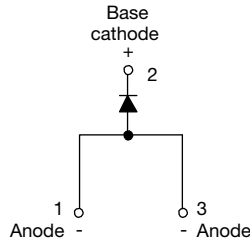

TO-252AA (D-PAK)



### FEATURES

- Glass passivated pellet chip junction
- Meets MSL level 1, per J-STD-020, LF maximum peak of 260 °C
- Material categorization: for definitions of compliance please see [www.vishay.com/doc?99912](http://www.vishay.com/doc?99912)



**RoHS**  
COMPLIANT  
HALOGEN  
**FREE**

### APPLICATIONS

- Output rectification and freewheeling diode in inverters, choppers and converters
- Input rectifications where severe restrictions on conducted EMI should be met

### DESCRIPTION

The VS-8EWF..S-M3 fast soft recovery rectifier series has been optimized for combined short reverse recovery time, low forward voltage drop and low leakage current.

The glass passivation ensures stable reliable operation in the most severe temperature and power cycling conditions.

| PRODUCT SUMMARY |                  |
|-----------------|------------------|
| Package         | TO-252AA (D-PAK) |
| $I_{F(AV)}$     | 8 A              |
| $V_R$           | 1000 V, 1200 V   |
| $V_F$ at $I_F$  | 1.3 V            |
| $I_{FSM}$       | 150 A            |
| $t_{rr}$        | 80 ns            |
| $T_J$ max.      | 150 °C           |
| Diode variation | Single die       |
| Snap factor     | 0.6              |

| MAJOR RATINGS AND CHARACTERISTICS |                           |             |       |
|-----------------------------------|---------------------------|-------------|-------|
| SYMBOL                            | CHARACTERISTICS           | VALUES      | UNITS |
| $I_{F(AV)}$                       | Sinusoidal waveform       | 8           | A     |
| $V_{RRM}$                         |                           | 1000/1200   | V     |
| $I_{FSM}$                         |                           | 150         | A     |
| $V_F$                             | 8 A, $T_J = 25\text{ °C}$ | 1.3         | V     |
| $t_{rr}$                          | 1 A, 100 A/ $\mu$ s       | 80          | ns    |
| $T_J$                             | Range                     | -40 to +150 | °C    |

| VOLTAGE RATINGS |   |  |                           |
|-----------------|---|--|---------------------------|
| PART NUMBER     | $V_{RRM}$ , MAXIMUM PEAK REVERSE VOLTAGE<br>V | $V_{RSM}$ , MAXIMUM NON-REPETITIVE PEAK REVERSE VOLTAGE<br>V | $I_{RRM}$ AT 150 °C<br>mA |
| VS-8EWF10S-M3   | 1000  | 1100   | 4                         |
| VS-8EWF12S-M3   | 1200  | 1300   |                           |

| ABSOLUTE MAXIMUM RATINGS                            |               |  |        |                           |
|---|---------------|--|--------|---------------------------|
| PARAMETER   | SYMBOL        | TEST CONDITIONS  | VALUES | UNITS                     |
| Maximum average forward current                     | $I_{F(AV)}$   | $T_C = 96\text{ °C}$ , 180° conduction half sine wave      | 8      | A                         |
| Maximum peak one cycle non-repetitive surge current | $I_{FSM}$     | 10 ms sine pulse, rated $V_{RRM}$ applied                  | 125    |                           |
|   |               | 10 ms sine pulse, no voltage reapplied                     | 150    |                           |
| Maximum $I^2t$ for fusing                           | $I^2t$        | 10 ms sine pulse, rated $V_{RRM}$ applied                  | 78     | A <sup>2</sup> s          |
|   |               | 10 ms sine pulse, no voltage reapplied                     | 110    |                           |
| Maximum $I^2\sqrt{t}$ for fusing                    | $I^2\sqrt{t}$ | $t = 0.1\text{ ms to }10\text{ ms}$ , no voltage reapplied | 1100   | A <sup>2</sup> $\sqrt{s}$ |



| <b>ELECTRICAL SPECIFICATIONS</b> |             |                                       |                               |        |            |
|----------------------------------|-------------|---------------------------------------|-------------------------------|--------|------------|
| PARAMETER                        | SYMBOL      | TEST CONDITIONS                       |                               | VALUES | UNITS      |
| Maximum forward voltage drop     | $V_{FM}$    | 8 A, $T_J = 25\text{ }^\circ\text{C}$ |                               | 1.3    | V          |
| Forward slope resistance         | $r_t$       | $T_J = 150\text{ }^\circ\text{C}$     |                               | 25.6   | m $\Omega$ |
| Threshold voltage                | $V_{F(TO)}$ |                                       |                               | 0.93   | V          |
| Maximum reverse leakage current  | $I_{RM}$    | $T_J = 25\text{ }^\circ\text{C}$      | $V_R = \text{Rated } V_{RRM}$ | 0.1    | mA         |
|                                  |             | $T_J = 150\text{ }^\circ\text{C}$     |                               | 4      |            |

| <b>RECOVERY CHARACTERISTICS</b> |          |   |        |         |  |
|---------------------------------|----------|---|--------|---------|--|
| PARAMETER                       | SYMBOL   | TEST CONDITIONS   | VALUES | UNITS   |  |
| Reverse recovery time           | $t_{rr}$ | $I_F$ at 8 A <sub>pk</sub><br>25 A/ $\mu$ s<br>$T_J = 25\text{ }^\circ\text{C}$ | 270    | ns      |  |
| Reverse recovery current        | $I_{rr}$ |   | 4.2    | A       |  |
| Reverse recovery charge         | $Q_{rr}$ |   | 1      | $\mu$ C |  |
| Snap factor                     | S        |   | 0.6    |         |  |

| <b>THERMAL - MECHANICAL SPECIFICATIONS</b>                  |                  |                             |             |                    |
|---|------------------|-----------------------------|-------------|--------------------|
| PARAMETER   | SYMBOL           | TEST CONDITIONS             | VALUES      | UNITS              |
| Maximum junction and storage temperature range              | $T_J, T_{Stg}$   |                             | -40 to +150 | $^\circ\text{C}$   |
| Maximum thermal resistance, junction to case                | $R_{thJC}$       | DC operation                | 2.5         | $^\circ\text{C/W}$ |
| Typical thermal resistance, junction to ambient (PCB mount) | $R_{thJA}^{(1)}$ |                             | 50          |                    |
| Soldering temperature                                       | $T_S$            | For 10 s                    | 260         | $^\circ\text{C}$   |
| Approximate weight  |                  |                             | 1           | g                  |
|   |                  |                             | 0.03        | oz.                |
| Marking device  |                  | Case style TO-252AA (D-PAK) | 8EWF10S     |                    |
|   |                  |                             | 8EWF12S     |                    |

**Note**

<sup>(1)</sup> When mounted on 1" square (650 mm<sup>2</sup>) PCB of FR-4 or G-10 material 4 oz. (140  $\mu$ m) copper 40  $^\circ\text{C/W}$   
For recommended footprint and soldering techniques refer to application note #AN-994

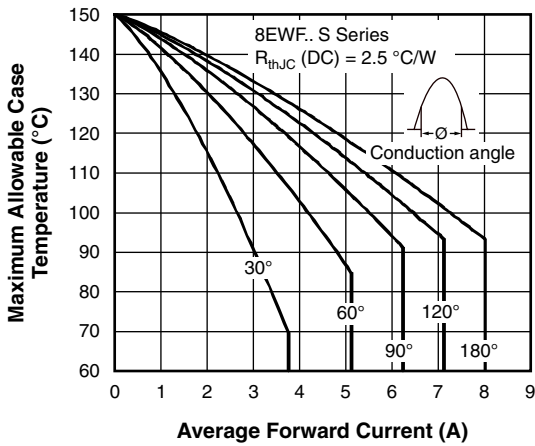

Fig. 1 - Current Rating Characteristics

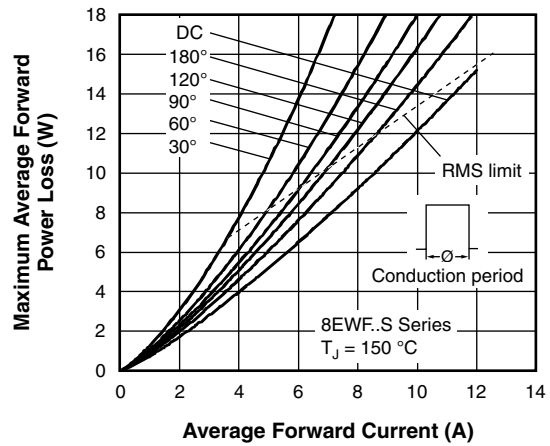

Fig. 4 - Forward Power Loss Characteristics

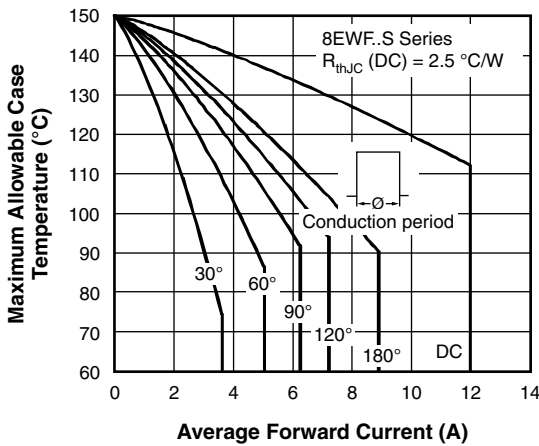

Fig. 2 - Current Rating Characteristics

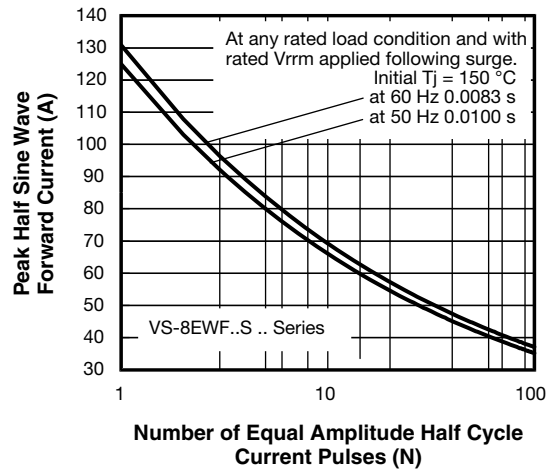

Fig. 5 - Maximum Non-Repetitive Surge Current

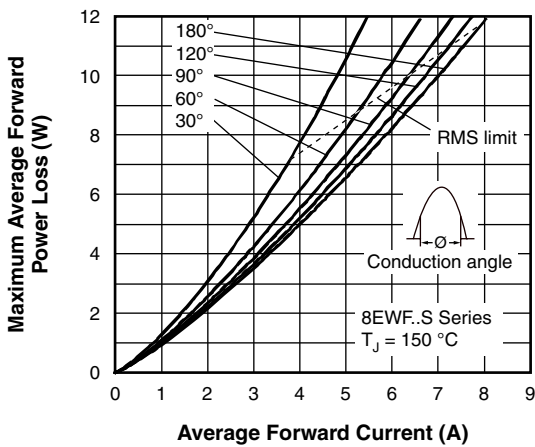

Fig. 3 - Forward Power Loss Characteristics

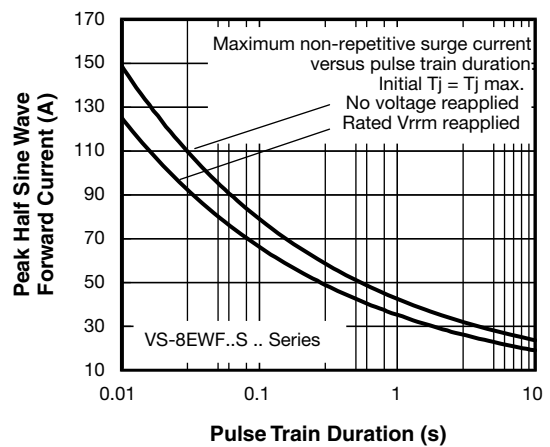

Fig. 6 - Maximum Non-Repetitive Surge Current

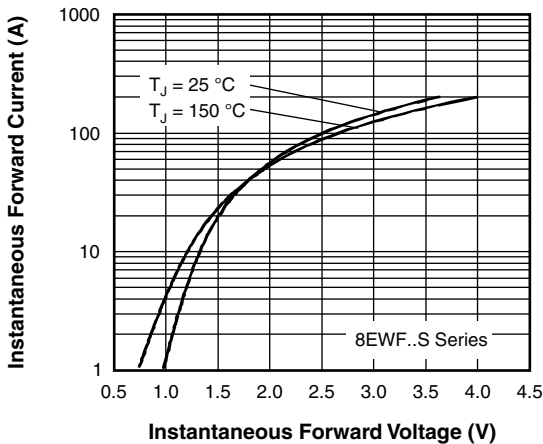

Fig. 7 - Forward Voltage Drop Characteristics

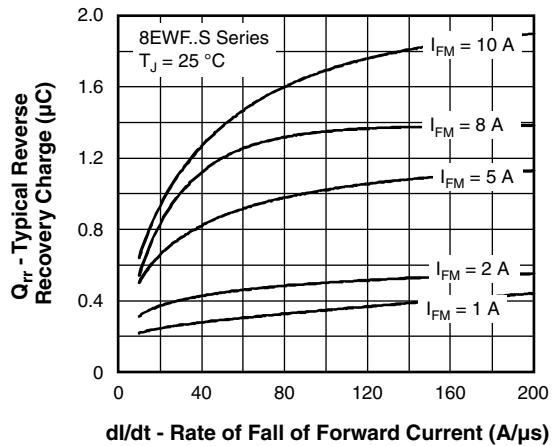

Fig. 10 - Recovery Charge Characteristics,  $T_J = 25\text{ }^\circ\text{C}$

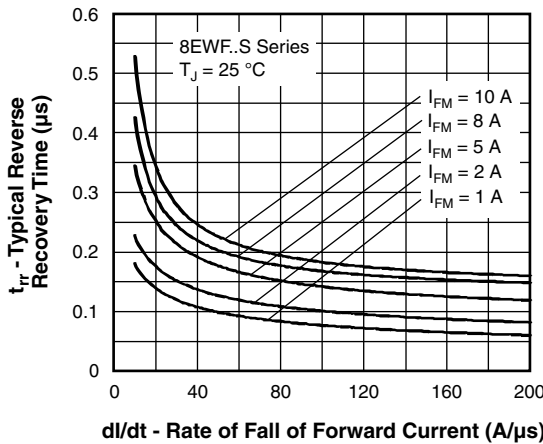

Fig. 8 - Recovery Time Characteristics,  $T_J = 25\text{ }^\circ\text{C}$

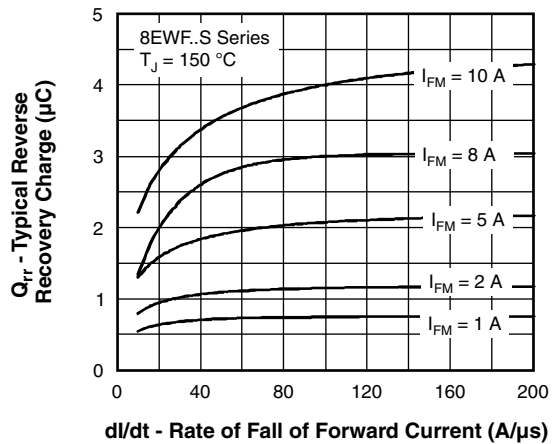

Fig. 11 - Recovery Charge Characteristics,  $T_J = 150\text{ }^\circ\text{C}$

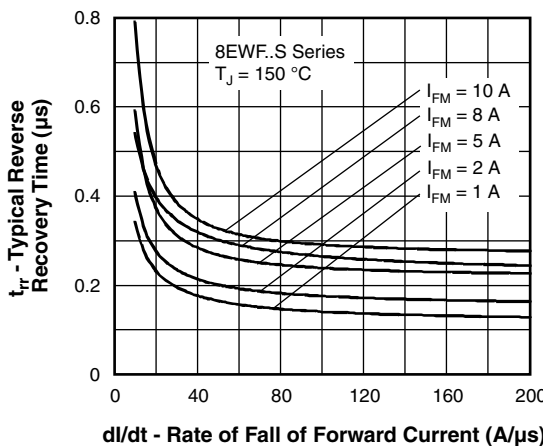

Fig. 9 - Recovery Time Characteristics,  $T_J = 150\text{ }^\circ\text{C}$

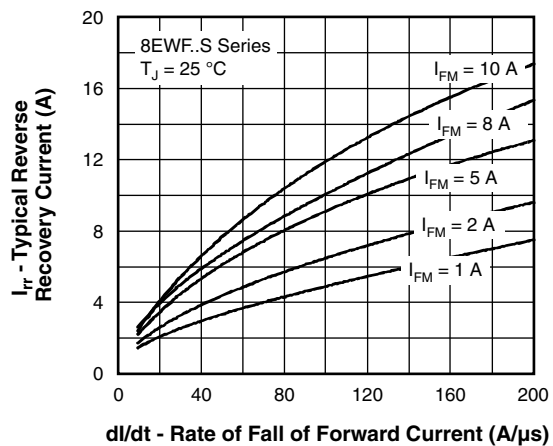

Fig. 12 - Recovery Current Characteristics,  $T_J = 25\text{ }^\circ\text{C}$

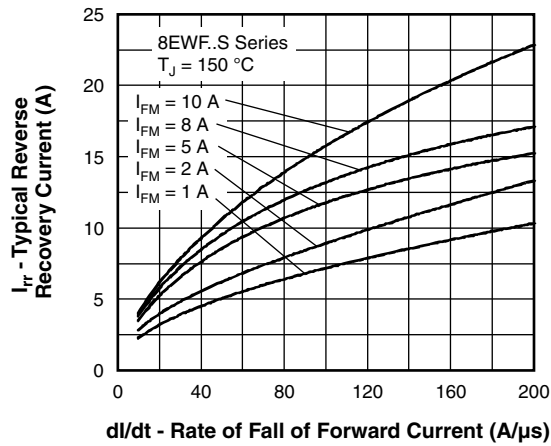

Fig. 13 - Recovery Current Characteristics,  $T_J = 150\text{ }^\circ\text{C}$

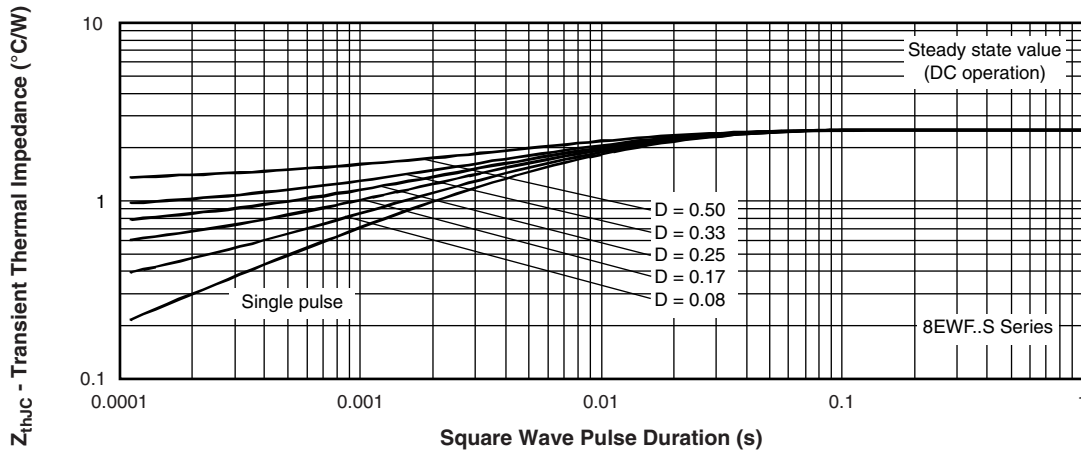
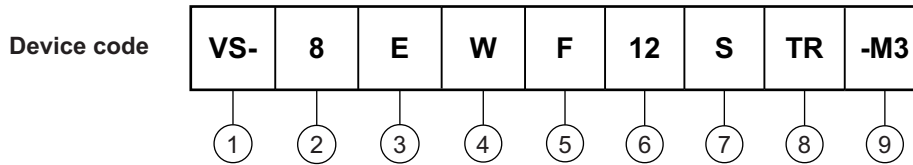

Fig. 14 - Thermal Impedance  $Z_{thJC}$  Characteristics



## ORDERING INFORMATION TABLE



- 1** - Vishay Semiconductors product
- 2** - Current rating (8 = 8 A)
- 3** - Circuit configuration:  
E = single diode
- 4** - Package:  
W = D-PAK
- 5** - Type of silicon:  
F = fast soft recovery rectifier
- 6** - Voltage code x 100 =  $V_{RRM}$ 

|             |
|-------------|
| 10 = 1000 V |
| 12 = 1200 V |
- 7** - S = surface mountable
- 8** -
  - TR = tape and reel
  - TRR = tape and reel (right oriented)
  - TRL = tape and reel (left oriented)
- 9** - Environmental digit:  
-M3 = halogen-free, RoHS-compliant, and terminations lead (Pb)-free

| ORDERING INFORMATION (Example) |                  |                        |                          |
|--------------------------------|------------------|------------------------|--------------------------|
| PREFERRED P/N                  | QUANTITY PER T/R | MINIMUM ORDER QUANTITY | PACKAGING DESCRIPTION    |
| VS-8EWF10S-M3                  | 75               | 3000                   | Antistatic plastic tubes |
| VS-8EWF10STR-M3                | 2000             | 2000                   | 13" diameter reel        |
| VS-8EWF10STRL-M3               | 3000             | 3000                   | 13" diameter reel        |
| VS-8EWF10STRR-M3               | 3000             | 3000                   | 13" diameter reel        |
| VS-8EWF12S-M3                  | 75               | 3000                   | Antistatic plastic tubes |
| VS-8EWF12STR-M3                | 2000             | 2000                   | 13" diameter reel        |
| VS-8EWF12STRL-M3               | 3000             | 3000                   | 13" diameter reel        |
| VS-8EWF12STRR-M3               | 3000             | 3000                   | 13" diameter reel        |

| LINKS TO RELATED DOCUMENTS |  |
|----------------------------|--|
| Dimensions                 | <a href="http://www.vishay.com/doc?95627">www.vishay.com/doc?95627</a> |
| Part marking information   | <a href="http://www.vishay.com/doc?95176">www.vishay.com/doc?95176</a> |
| Packaging information      | <a href="http://www.vishay.com/doc?95033">www.vishay.com/doc?95033</a> |
| SPICE model                | <a href="http://www.vishay.com/doc?95552">www.vishay.com/doc?95552</a> |



# D-PAK (TO-252AA) "M"

**DIMENSIONS** in millimeters and inches

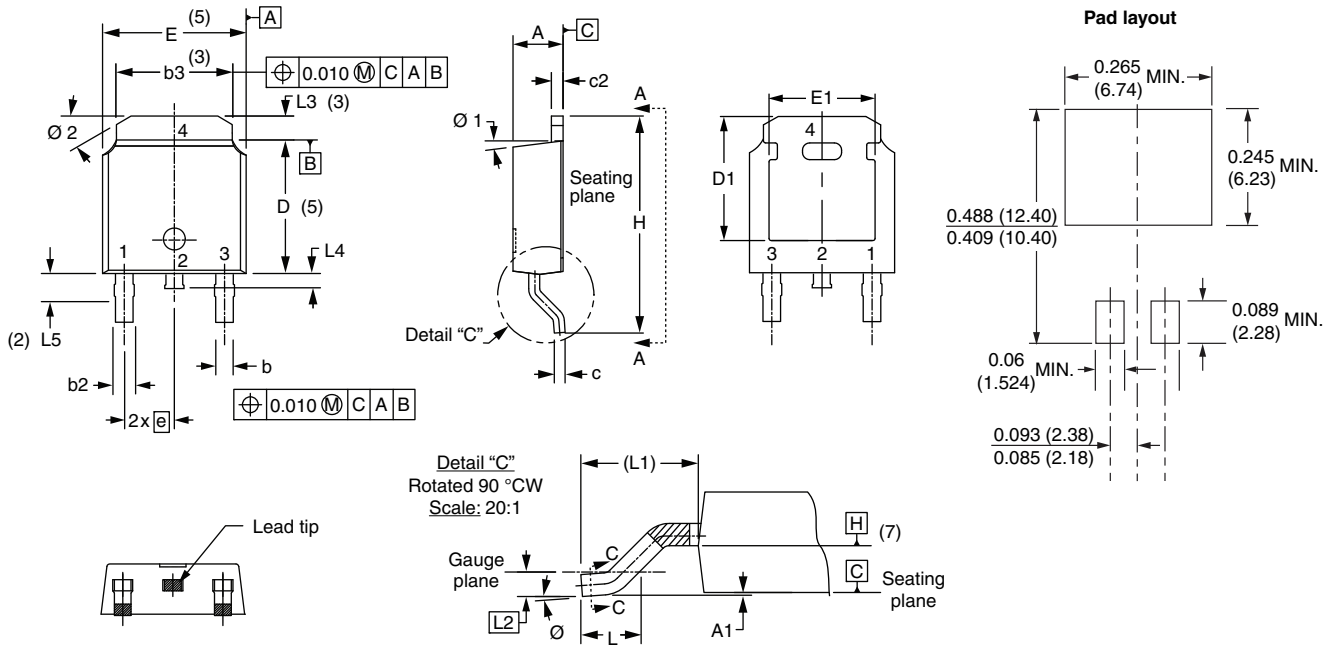

| SYMBOL | MILLIMETERS |      | INCHES |       | NOTES | SYMBOL | MILLIMETERS |       | INCHES     |       | NOTES |
|--------|-------------|------|--------|-------|-------|--------|-------------|-------|------------|-------|-------|
|        | MIN.        | MAX. | MIN.   | MAX.  |       |        | MIN.        | MAX.  | MIN.       | MAX.  |       |
| A      | 2.18        | 2.39 | 0.086  | 0.094 |       | e      | 2.29 BSC    |       | 0.090 BSC  |       |       |
| A1     | -           | 0.13 | -      | 0.005 |       | H      | 9.40        | 10.41 | 0.370      | 0.410 |       |
| b      | 0.64        | 0.89 | 0.025  | 0.035 |       | L      | 1.40        | 1.78  | 0.055      | 0.070 |       |
| b2     | 0.76        | 1.14 | 0.030  | 0.045 |       | L1     | 2.74 BSC    |       | 0.108 REF. |       |       |
| b3     | 4.95        | 5.46 | 0.195  | 0.215 | 3     | L2     | 0.51 BSC    |       | 0.020 BSC  |       |       |
| c      | 0.46        | 0.61 | 0.018  | 0.024 |       | L3     | 0.89        | 1.27  | 0.035      | 0.050 | 3     |
| c2     | 0.46        | 0.89 | 0.018  | 0.035 |       | L4     | -           | 1.02  | -          | 0.040 |       |
| D      | 5.97        | 6.22 | 0.235  | 0.245 | 5     | L5     | 1.14        | 1.52  | 0.045      | 0.060 | 2     |
| D1     | 5.21        | -    | 0.205  | -     | 3     | Ø      | 0°          | 10°   | 0°         | 10°   |       |
| E      | 6.35        | 6.73 | 0.250  | 0.265 | 5     | Ø1     | 0°          | 15°   | 0°         | 15°   |       |
| E1     | 4.32        | -    | 0.170  | -     | 3     | Ø2     | 25°         | 35°   | 25°        | 35°   |       |

**Notes**

- (1) Dimensioning and tolerancing as per ASME Y14.5M-1994
- (2) Lead dimension uncontrolled in L5
- (3) Dimension D1, E1, L3 and b3 establish a minimum mounting surface for thermal pad
- (4) Section C - C dimension apply to the flat section of the lead between 0.13 and 0.25 mm (0.005 and 0.10") from the lead tip
- (5) Dimension D, and E do not include mold flash. Mold flash shall not exceed 0.127 mm (0.005") per side. These dimensions are measured at the outermost extremes of the plastic body
- (6) Dimension b1 and c1 applied to base metal only
- (7) Datum A and B to be determined at datum plane H
- (8) Outline conforms to JEDEC® outline TO-252AA



## Disclaimer

ALL PRODUCT, PRODUCT SPECIFICATIONS AND DATA ARE SUBJECT TO CHANGE WITHOUT NOTICE TO IMPROVE RELIABILITY, FUNCTION OR DESIGN OR OTHERWISE.

Vishay Intertechnology, Inc., its affiliates, agents, and employees, and all persons acting on its or their behalf (collectively, "Vishay"), disclaim any and all liability for any errors, inaccuracies or incompleteness contained in any datasheet or in any other disclosure relating to any product.

Vishay makes no warranty, representation or guarantee regarding the suitability of the products for any particular purpose or the continuing production of any product. To the maximum extent permitted by applicable law, Vishay disclaims (i) any and all liability arising out of the application or use of any product, (ii) any and all liability, including without limitation special, consequential or incidental damages, and (iii) any and all implied warranties, including warranties of fitness for particular purpose, non-infringement and merchantability.

Statements regarding the suitability of products for certain types of applications are based on Vishay's knowledge of typical requirements that are often placed on Vishay products in generic applications. Such statements are not binding statements about the suitability of products for a particular application. It is the customer's responsibility to validate that a particular product with the properties described in the product specification is suitable for use in a particular application. Parameters provided in datasheets and / or specifications may vary in different applications and performance may vary over time. All operating parameters, including typical parameters, must be validated for each customer application by the customer's technical experts. Product specifications do not expand or otherwise modify Vishay's terms and conditions of purchase, including but not limited to the warranty expressed therein.

Except as expressly indicated in writing, Vishay products are not designed for use in medical, life-saving, or life-sustaining applications or for any other application in which the failure of the Vishay product could result in personal injury or death. Customers using or selling Vishay products not expressly indicated for use in such applications do so at their own risk. Please contact authorized Vishay personnel to obtain written terms and conditions regarding products designed for such applications.

No license, express or implied, by estoppel or otherwise, to any intellectual property rights is granted by this document or by any conduct of Vishay. Product names and markings noted herein may be trademarks of their respective owners.