

Features

- Attenuation: 1 dB Steps to 50 dB
- Low DC Power Consumption
- Integral TTL Driver
- 50 ohm Impedance
- Test Boards are Available
- Tape and Reel Packaging Available
- Lead-Free SOW-24 Package
- 100% Matte Tin Plating over Copper
- Halogen-Free “Green” Mold Compound
- 260°C Reflow Compatible
- RoHS* Compliant Version of AT65-0106

Description

MACOM's MAAD-007086-000100 is a GaAs FET 6-bit digital attenuator with a 1 dB minimum step size and a 50 dB total attenuation range. This device is in a SOW-24, wide body plastic surface mount package. The MAAD-007086-000100 is ideally suited for use where accuracy, fast speed, very low power consumption and low costs are required.

Ordering Information

Part Number	Package
MAAD-007086-000100	Bulk Packaging
MAAD-007086-0001TR	1000 piece reel
MAAD-007086-0001TB	Sample Test Board

Note: Reference Application Note M513 for reel size information.

Schematic with Off-Chip Components

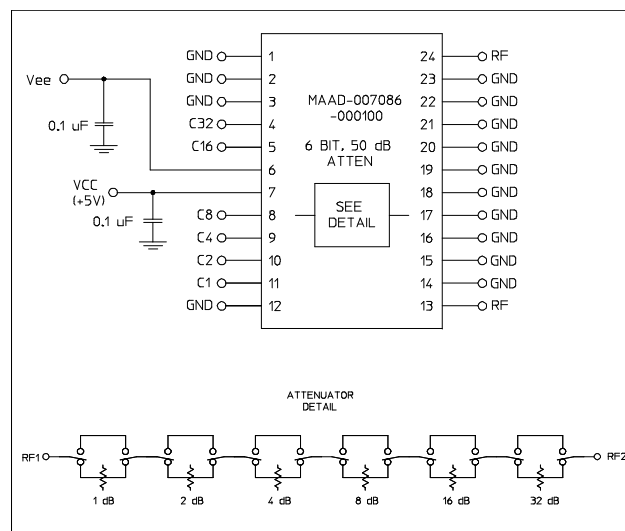

Pin Configuration

Pin No.	Function	Pin No.	Function
1	GND	13	RF
2	GND	14	GND
3	GND	15	GND
4	C32	16	GND
5	C16	17	GND
6	V _{EE}	18	GND
7	V _{CC}	19	GND
8	C8	20	GND
9	C4	21	GND
10	C2	22	GND
11	C1	23	GND
12	GND	24	RF

* Restrictions on Hazardous Substances, European Union Directive 2002/95/EC.

Digital Attenuator 50 dB, 6-Bit, TTL Driver, DC - 2.0 GHz

Rev. V4

Electrical Specifications: $T_A = 25^\circ\text{C}$, $Z_0 = 50\Omega$

Parameter	Test Conditions	Frequency	Units	Min	Typ	Max
Insertion Loss	—	DC - 2.0 GHz	dB	—	4.2	4.7
Attenuation Accuracy	Individual Bits 1-2-4-8-16-32 dB	DC - 2.0 GHz	dB	—	—	$\pm(.3 + 3\%$ of atten setting)
	Any Combination of Bits 3 to 15 dB	DC - 2.0 GHz	dB	—	—	$\pm(.5 + 5\%$ of atten setting)
	Any Combination of Bits 17 to 31 dB	DC - 2.0 GHz	dB	—	—	$\pm(.3 + 3\%$ of atten setting)
	Any Combination of Bits 32 to 50 dB	DC - 2.0 GHz	dB	—	—	$\pm(.5 + 7\%$ of atten setting)
VSWR	Full Range	DC - 2.0 GHz	Ratio	—	1.8:1	2:1
Switching Speed ¹	50% Cntl to 90%/10% RF	—	ns	—	75	150
	10% to 90% or 90% to 10%	—	ns	—	20	50
1 dB Compression	—	50 MHz	dBm	—	+21	—
	—	0.5 - 2.0 GHz	dBm	—	+24	—
Input IP_3	Two-tone inputs up to +5 dBm @ 0 dB Attenuation	50 MHz	dB	—	+35	—
		0.5-2.0 GHz	dB	—	+48	—
V _{CC}	—	—	V	4.75	5.0	5.25
V _{EE}	—	—	V	-8.0	-5.0	-4.75
V _{IL} V _{IH}	LOW-level input voltage	—	V	0.0	—	0.8
	HIGH-level input voltage	—	V	2.0	—	5.0
I _{in} (Input Leakage Current)	V _{in} = V _{CC} or GND	—	uA	-1.0	—	1.0
I _{CC} (Quiescent Supply Current)	V _{cntrl} = V _{CC} or GND	—	uA	—	250	400
ΔI_{CC} (Additional Supply Current Per TTL Input Pin)	V _{CC} = Max, V _{cntrl} = V _{CC} - 2.1 V	—	mA	—	—	1.0
I _{EE}	V _{EE} min to max, V _{in} = V _{IL} or V _{IH}	—	mA	-1.0	-0.2	—
Thermal Resistance θ_{JA}	PCB mount on FR4 material, copper trace, still air at +25°C	—	°C/W	—	60-80	—

1. Decoupling capacitors (.01 μ F) are required on power supply lines.

Absolute Maximum Ratings^{2,3}

Parameter	Absolute Maximum
Max. Input Power 0.05 GHz 0.5 - 2.0 GHz	+27 dBm +34 dBm
V _{CC}	-0.5V \leq V _{CC} \leq +7.0V
V _{EE}	-8.5V \leq V _{EE} \leq +0.5V
V _{CC} - V _{EE}	-0.5V \leq V _{CC} - V _{EE} \leq 14.5V
V _{in} ⁴	-0.5V \leq V _{in} \leq V _{CC} + 0.5V
Operating Temperature	-40°C to +85°C
Storage Temperature	-65°C to +125°C

- Exceeding any one or combination of these limits may cause permanent damage to this device.
- MACOM does not recommend sustained operation near these survivability limits.
- Standard CMOS TTL interface, latch-up will occur if logic signal is applied prior to power supply.

Handling Procedures

Please observe the following precautions to avoid damage:

Static Sensitivity

Gallium Arsenide Integrated Circuits are sensitive to electrostatic discharge (ESD) and can be damaged by static electricity. Proper ESD control techniques should be used when handling these devices.

2

MACOM Technology Solutions Inc. (MACOM) and its affiliates reserve the right to make changes to the product(s) or information contained herein without notice. Visit www.macom.com for additional data sheets and product information.

Truth Table (Digital Attenuator)

C32	C16	C8	C4	C2	C1	Attenuation
0	0	0	0	0	0	Loss, Reference
0	0	0	0	0	1	1 dB
0	0	0	0	1	0	2 dB
0	0	0	1	0	0	4 dB
0	0	1	0	0	0	8 dB
0	1	0	0	0	0	16 dB
1	0	0	0	0	0	32 dB
1	1	0	0	1	0	50 dB

0 = TTL Low; 1 = TTL High

Typical Performance Curves

Insertion Loss vs. Temperature

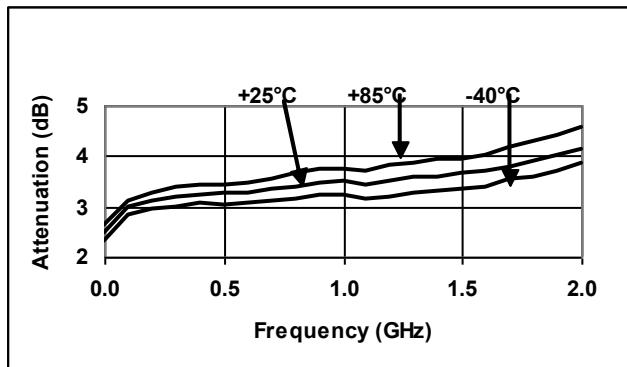

1 dB Attenuation Variation from -40°C to +85°C

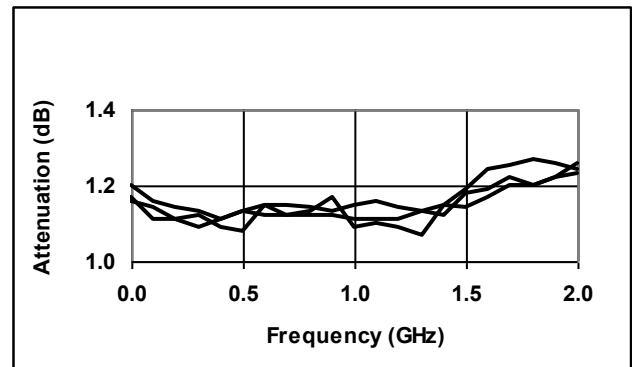

2 dB Attenuation Variation from -40°C to +85°C

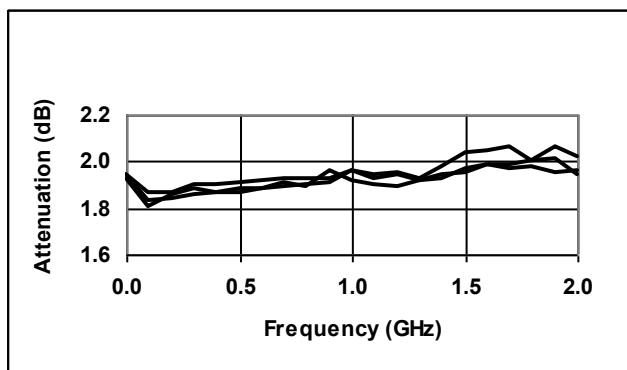

4 dB Attenuation Variation from -40°C to +85°C

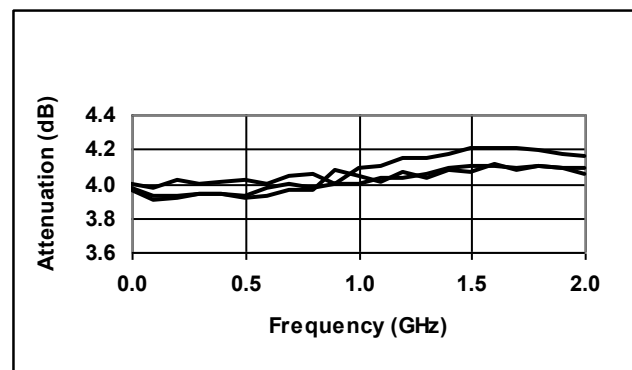

Typical Performance Curves

8 dB Attenuation Variation from -40°C to +85°C

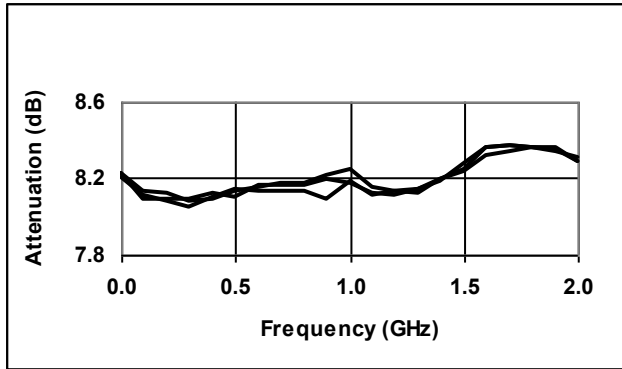

16 dB Attenuation Variation from -40°C to +85°C

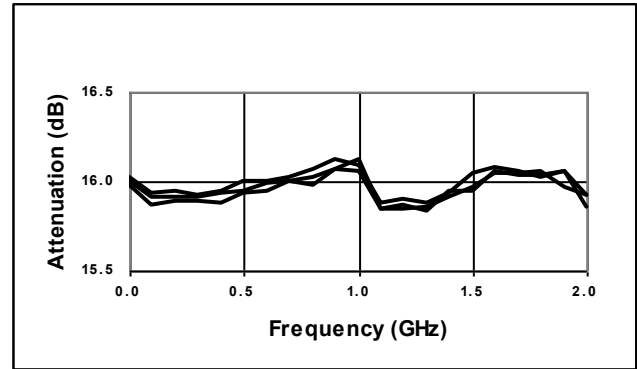

32 dB Attenuation Variation from -40°C to +85°C

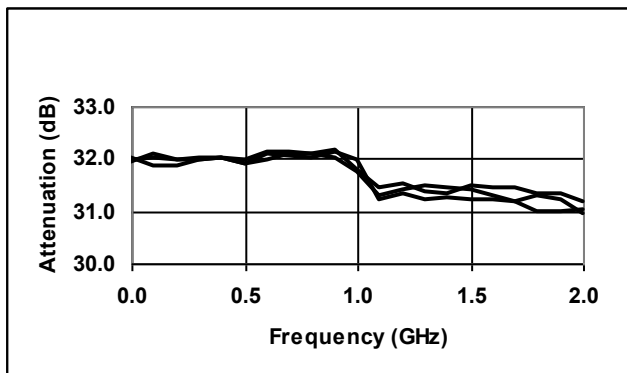

Max. Attenuation Variation from -40°C to +85°C

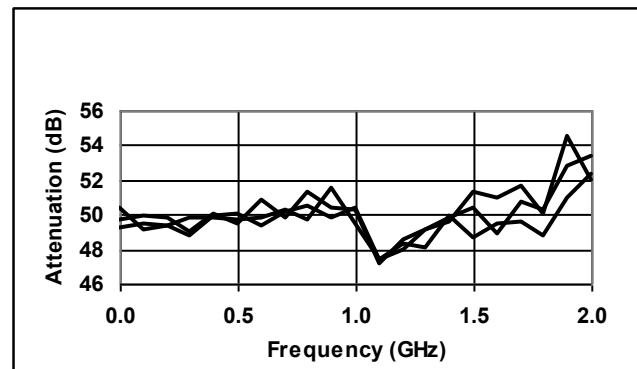

Reference Loss VSWR (S11, S22)

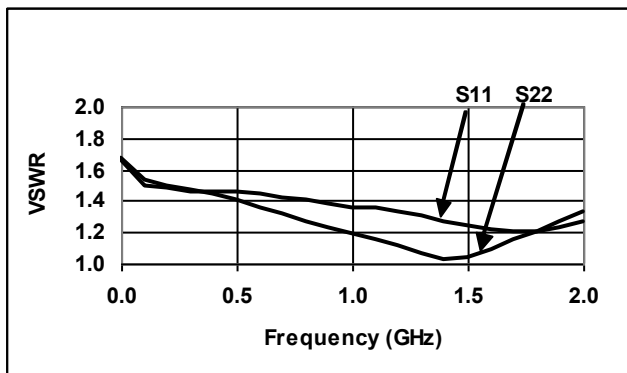

1 dB VSWR (S11, S22)

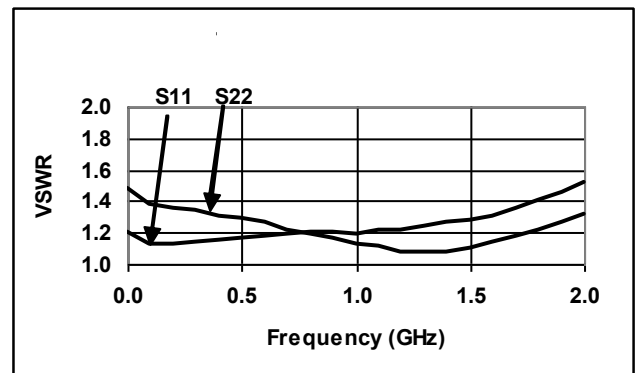

Typical Performance Curves

2 dB VSWR (S11, S22)

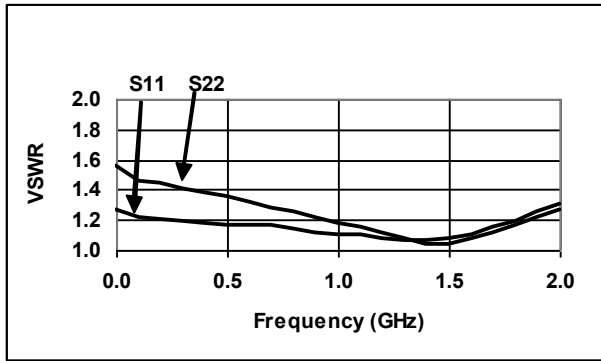

4 dB VSWR (S11, S22)

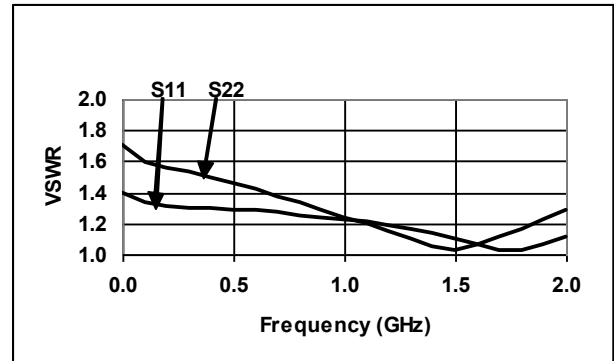

8 dB VSWR (S11, S22)

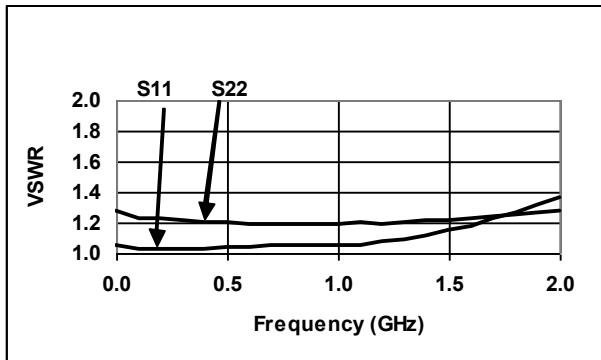

16 dB VSWR (S11, S22)

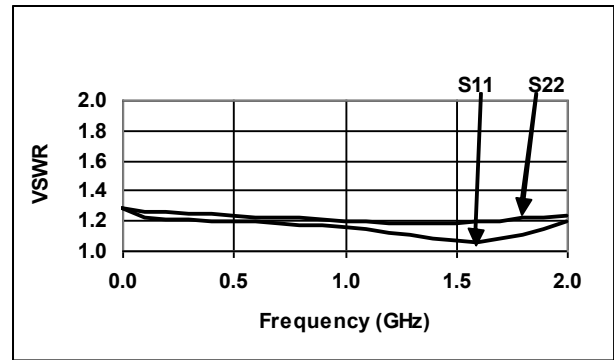

32 dB VSWR (S11, S22)

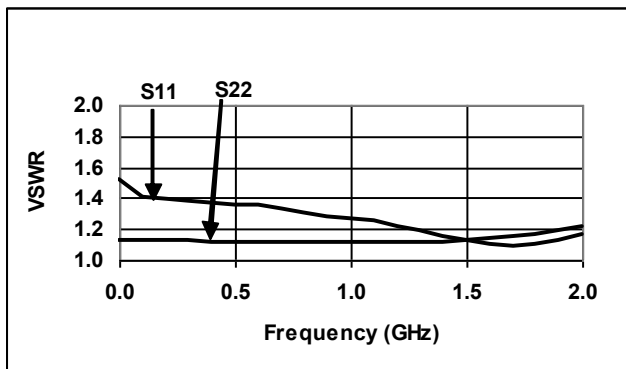

50 dB VSWR (S11, S22)

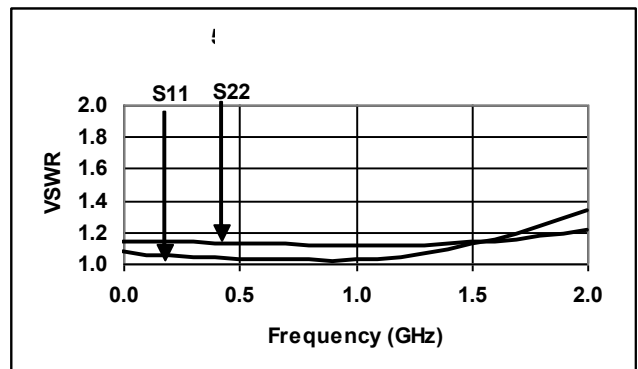

Lead-Free, SOW-24[†]

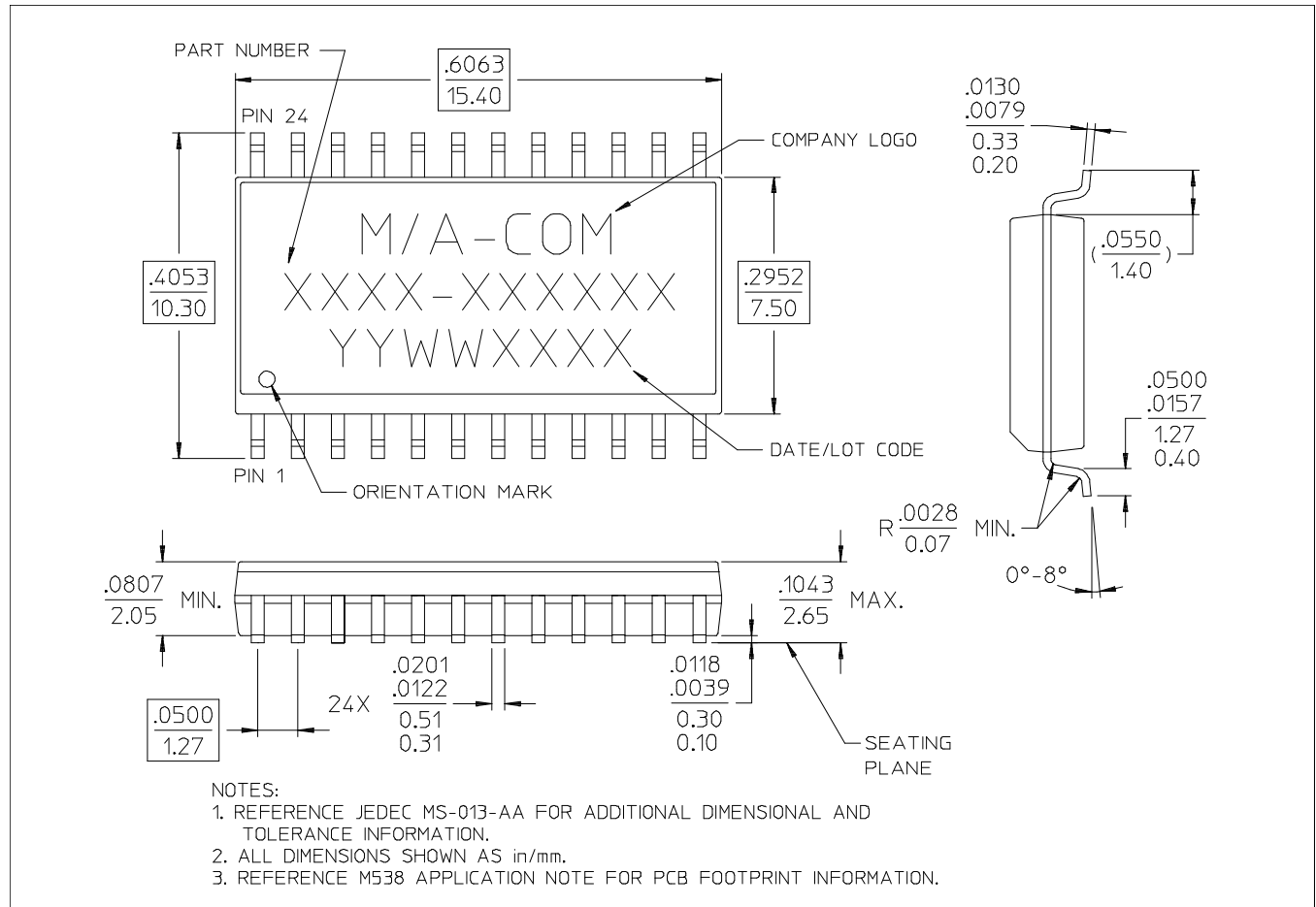

[†] Reference Application Note M538 for lead-free solder reflow recommendations.

M/A-COM Technology Solutions Inc. All rights reserved.

Information in this document is provided in connection with M/A-COM Technology Solutions Inc ("MACOM") products. These materials are provided by MACOM as a service to its customers and may be used for informational purposes only. Except as provided in MACOM's Terms and Conditions of Sale for such products or in any separate agreement related to this document, MACOM assumes no liability whatsoever. MACOM assumes no responsibility for errors or omissions in these materials. MACOM may make changes to specifications and product descriptions at any time, without notice. MACOM makes no commitment to update the information and shall have no responsibility whatsoever for conflicts or incompatibilities arising from future changes to its specifications and product descriptions. No license, express or implied, by estoppel or otherwise, to any intellectual property rights is granted by this document.

THESE MATERIALS ARE PROVIDED "AS IS" WITHOUT WARRANTY OF ANY KIND, EITHER EXPRESS OR IMPLIED, RELATING TO SALE AND/OR USE OF MACOM PRODUCTS INCLUDING LIABILITY OR WARRANTIES RELATING TO FITNESS FOR A PARTICULAR PURPOSE, CONSEQUENTIAL OR INCIDENTAL DAMAGES, MERCHANTABILITY, OR INFRINGEMENT OF ANY PATENT, COPYRIGHT OR OTHER INTELLECTUAL PROPERTY RIGHT. MACOM FURTHER DOES NOT WARRANT THE ACCURACY OR COMPLETENESS OF THE INFORMATION, TEXT, GRAPHICS OR OTHER ITEMS CONTAINED WITHIN THESE MATERIALS. MACOM SHALL NOT BE LIABLE FOR ANY SPECIAL, INDIRECT, INCIDENTAL, OR CONSEQUENTIAL DAMAGES, INCLUDING WITHOUT LIMITATION, LOST REVENUES OR LOST PROFITS, WHICH MAY RESULT FROM THE USE OF THESE MATERIALS.

MACOM products are not intended for use in medical, lifesaving or life sustaining applications. MACOM customers using or selling MACOM products for use in such applications do so at their own risk and agree to fully indemnify MACOM for any damages resulting from such improper use or sale.