



## LOW DROP POWER SCHOTTKY RECTIFIER

**Table 1: Main Product Characteristics**

$I_{F(AV)}$	0.5 A
$V_{RRM}$	20 V
$T_j$ (max)	150°C
$V_F$ (max)	0.30 V

### FEATURES AND BENEFITS

- Very small conduction losses
- Negligible switching losses
- Extremely fast switching
- Low forward voltage drop for higher efficiency and extended battery life
- Low thermal resistance
- Avalanche capability specified

### DESCRIPTION

Single Schottky rectifier suited for switch mode power supplies and high frequency DC to DC converters.

Packaged in STmite, this device is intended for use in low voltage, high frequency inverters, free wheeling and polarity protection applications. Due to the small size of the package this device fits battery powered equipment (cellular, notebook, PDA's, printers) as well chargers and PCMCIA cards.

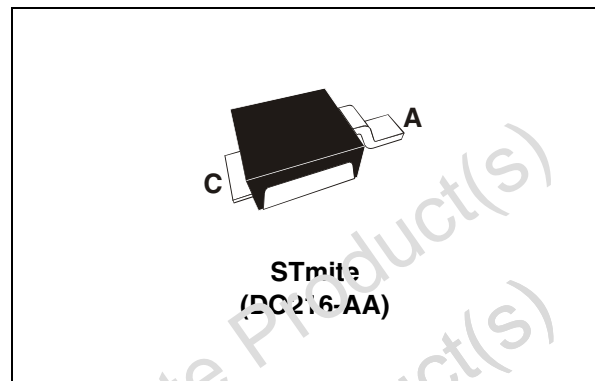

**Table 2: Order Code**

Part Number	Marking
STPS0520M	052

**Table 3: Absolute Ratings** (limiting values)

Symbol	Parameter	Value	Unit
$V_{RRM}$	Repetitive peak reverse voltage	20	V
$I_{F(RMS)}$	RMS forward current	2	A
$I_{F(AV)}$	Average forward current	$T_c = 140^\circ\text{C} \quad \delta = 0.5$	A
$I_{FSM}$	Surge non repetitive forward current	$t_p = 10 \text{ ms sinusoidal}$	A
$P_{ARM}$	Repetitive peak avalanche power	$t_p = 1\mu\text{s} \quad T_j = 25^\circ\text{C}$	W
$T_{stg}$	Storage temperature range	-65 to + 150	°C
$T_j$	Maximum operating junction temperature *	150	°C
dV/dt	Critical rate of rise of reverse voltage (rated $V_R$ , $T_j = 25^\circ\text{C}$ )	10000	V/ $\mu\text{s}$

\*:  $\frac{dP_{tot}}{dT_j} > \frac{1}{R_{th(j-a)}}$  thermal runaway condition for a diode on its own heatsink

# STPS0520M

**Table 4: Thermal Resistance**

Symbol	Parameter	Value	Unit
$R_{th(j-c)}$	Junction to case	20	°C/W
$R_{th(j-l)}^*$	Junction to ambient	250	°C/W

\* Mounted with minimum recommended pad size, PC board FR4.

**Table 5: Static Electrical Characteristics**

Symbol	Parameter	Tests conditions	Min.	Typ	Max.	Unit
$I_R^*$	Reverse leakage current	$T_j = 25^\circ\text{C}$	$V_R = V_{RRM}$	15	50	$\mu\text{A}$
		$T_j = 100^\circ\text{C}$		2	6	$\text{mA}$
		$T_j = 25^\circ\text{C}$	$V_R = 10\text{V}$	7	25	$\mu\text{A}$
		$T_j = 100^\circ\text{C}$		1	3	$\text{mA}$
$V_F^*$	Forward voltage drop	$T_j = 25^\circ\text{C}$	$I_F = 0.5\text{A}$	0.35	0.385	V
		$T_j = 100^\circ\text{C}$		0.25	0.30	
		$T_j = 25^\circ\text{C}$	$I_F = 1\text{A}$	0.38	0.415	
		$T_j = 100^\circ\text{C}$		0.30	0.338	

Pulse test: \*  $t_p = 380 \mu\text{s}$ ,  $\delta < 2\%$

To evaluate the conduction losses use the following equation:  $P = 0.21 I_F(AV) + 0.175 I_F^2 (RMS)$

**Figure 1: Conduction losses versus average current**

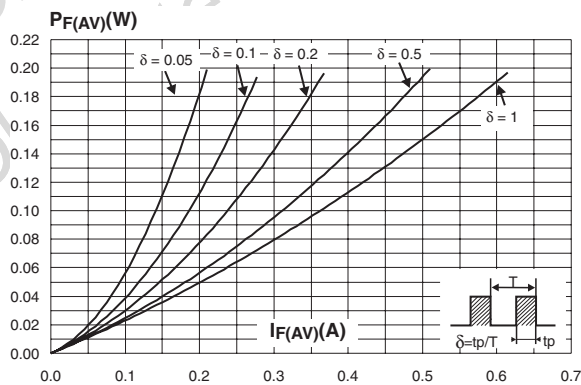

**Figure 2: Average forward current versus ambient temperature ( $\delta = 0.5$ )**

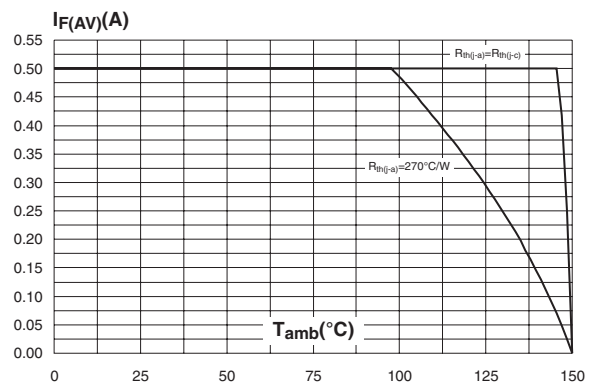

Figure 3: Normalized avalanche power derating versus pulse duration

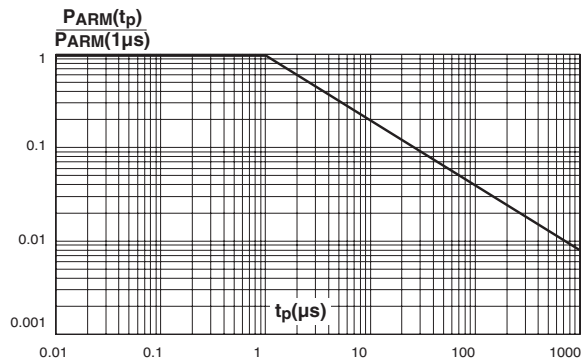

Figure 4: Normalized avalanche power derating versus junction temperature

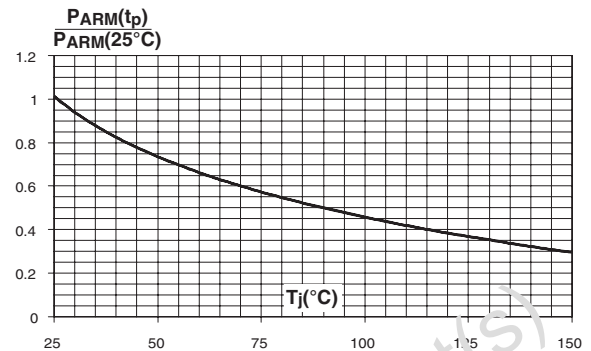

Figure 5: Non repetitive surge peak forward current versus overload duration (maximum values)

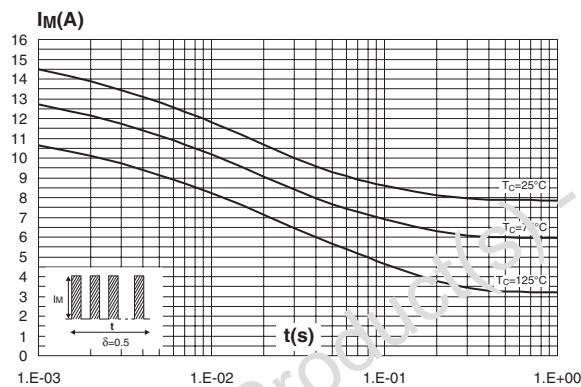

Figure 6: Relative variation of thermal impedance junction to ambient versus pulse duration

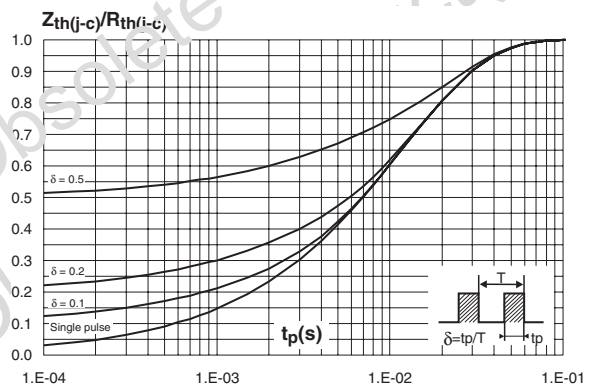

Figure 7: Reverse leakage current versus reverse voltage applied (typical values)

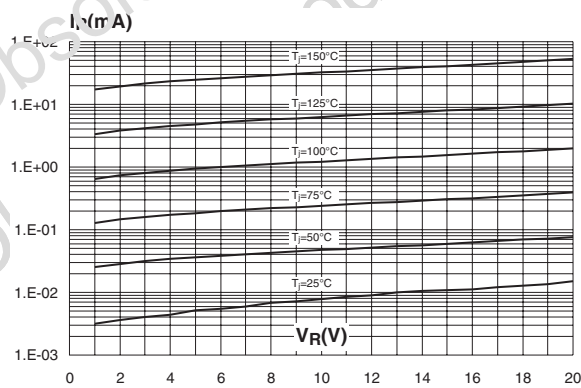

Figure 8: Reverse leakage current versus junction temperature (typical values)

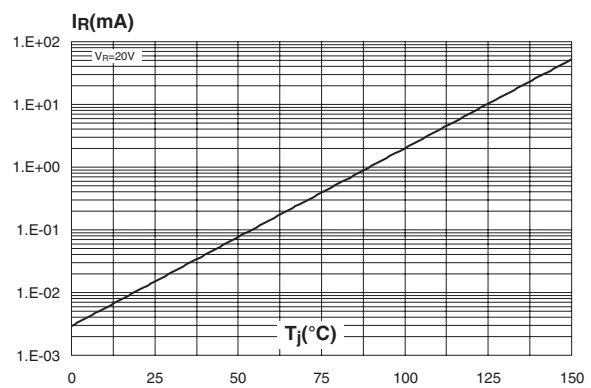

Figure 9: Junction capacitance versus reverse voltage applied (typical values)

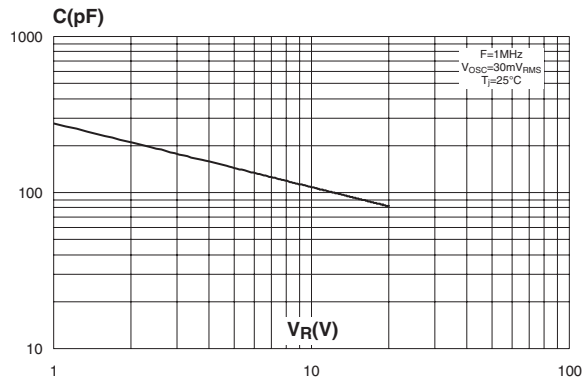

Figure 10: Forward voltage drop versus forward current

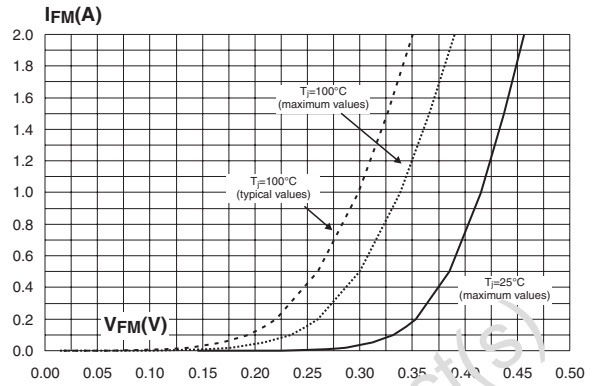

Figure 11: Thermal resistance junction to ambient versus copper surface under tab (epoxy printed board FR4, Cu = 35µm, typical values)

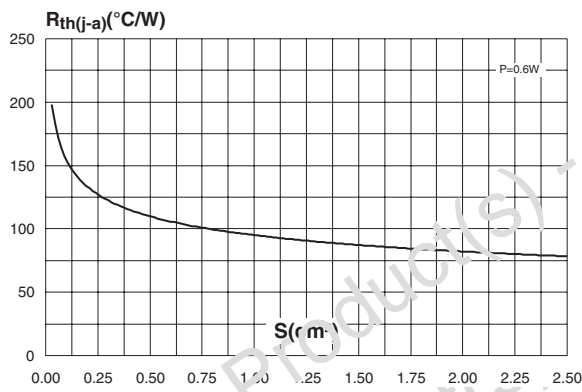

Figure 12: STmite Package Mechanical Data

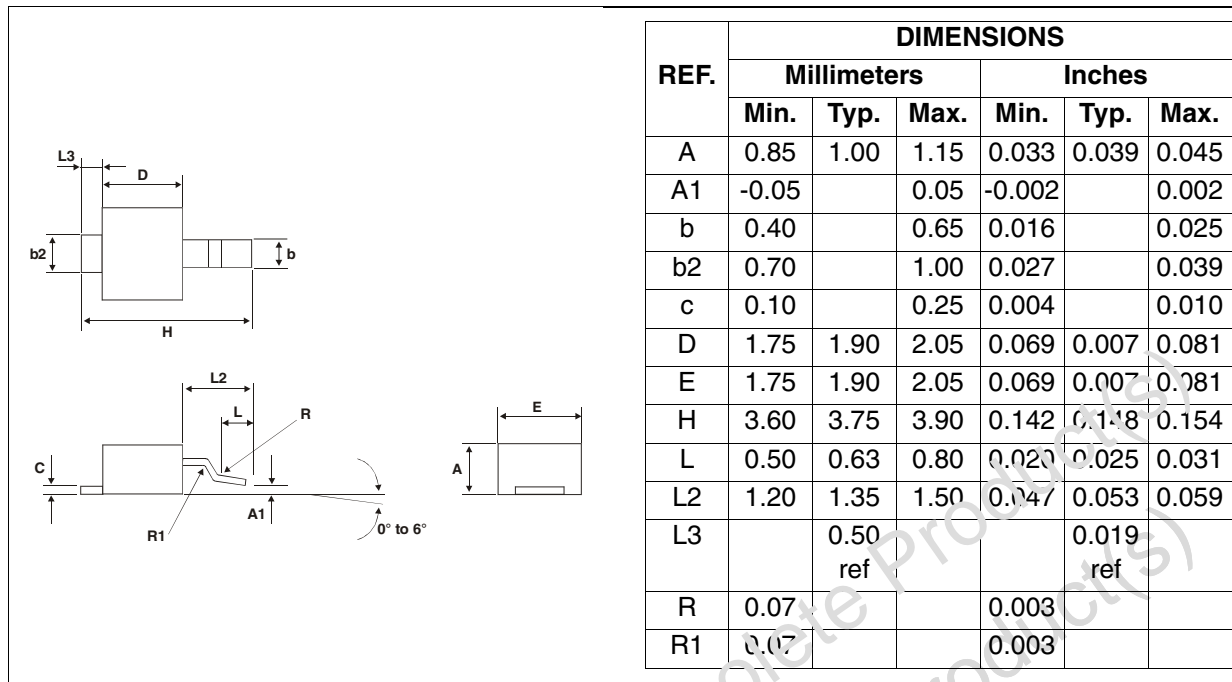

Figure 13: Foot Print Dimensions (in millimeters)

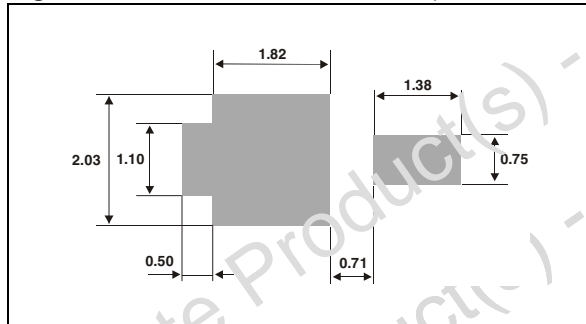

Table 6: Ordering Information

Ordering type	Marking	Package	Weight	Base qty	Delivery mode
STPS0520M	052	STmite	15.5 mg	12000	Tape & reel

Table 7: Revision History

Date	Revision	Description of Changes
Jul-2003	2A	Last update.
13-Sep-2004	3	STmite package dimensions reference A1 change: from blank (min) to -0.05mm and from 0.10 (max) to 0.05mm.
29-Nov-2005	4	Page 2, table 5: conduction losses evaluation values changed: . From $P = 0.34 \times I_{F(AV)} + 0.07 I_{F(RMS)}^2$ . To $P = 0.21 \times I_{F(AV)} + 0.175 I_{F(RMS)}^2$

Information furnished is believed to be accurate and reliable. However, STMicroelectronics assumes no responsibility for the consequences of use of such information nor for any infringement of patents or other rights of third parties which may result from its use. No license is granted by implication or otherwise under any patent or patent rights of STMicroelectronics. Specifications mentioned in this publication are subject to change without notice. This publication supersedes and replaces all information previously supplied. STMicroelectronics products are not authorized for use as critical components in life support devices or systems without express written approval of STMicroelectronics.

The ST logo is a registered trademark of STMicroelectronics.  
All other names are the property of their respective owners

© 2005 STMicroelectronics - All rights reserved

**STMicroelectronics group of companies**

Australia - Belgium - Brazil - Canada - China - Czech Republic - Finland - France - Germany - Hong Kong - India - Israel - Italy - Japan - Malaysia - Malta - Morocco - Singapore - Spain - Sweden - Switzerland - United Kingdom - United States of America

**[www.st.com](http://www.st.com)**