

New

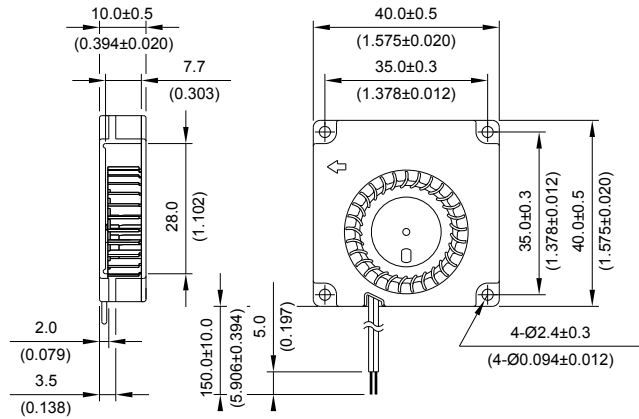

BFB 40 x 40 x 10 MM SERIES

DIMENSIONS DRAWING



UNIT : $\frac{\text{mm}}{\text{(INCH)}}$

- * Bearing Type
Ball Bearings
- * Material
Impeller & Frame : Plastic (UL 94V-0)
- * Lead Wires :
UL 1571 AWG #28 OR Equivalent
Red Wire Positive(+)
Black Wire Negative(-)
- * Weight : 12g (0.42 oz)

P & Q CURVE (AT RATED VOLTAGE)

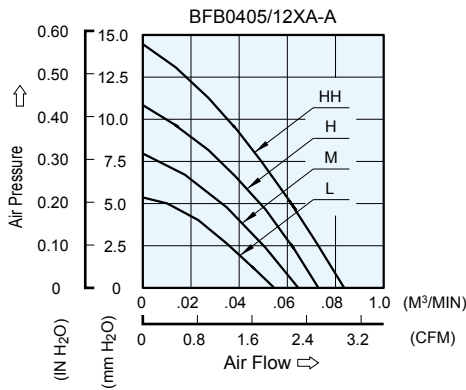

MODEL			Rated Voltage	Operating Voltage Range	Input Current	Input Power	Speed	Maximum Air Flow		Maximum Air Pressure		Noise
PART NO.	REV.	FUNCTION	VDC	VDC	Amp	Watt	R.P.M.	m ³ / min	CFM	mmH ₂ O	IN H ₂ O	dB-A
BFB0405LA	-A	-R00 / -F00	5	4.0 to 5.5	0.06	0.30	5500	0.055	1.94	5.37	0.211	28.0
BFB0412LA	-A	-R00 / -F00	12	7.0 to 13.2	0.04	0.48						
BFB0405MA	-A	-R00 / -F00	5	4.0 to 5.5	0.08	0.40	6500	0.065	2.30	7.93	0.312	29.5
BFB0412MA	-A	-R00 / -F00	12	7.0 to 13.2	0.05	0.60						
BFB0405HA	-A	-R00 / -F00	5	4.0 to 5.5	0.11	0.55	7500	0.074	2.61	10.85	0.427	32.5
BFB0412HA	-A	-R00 / -F00	12	7.0 to 13.2	0.06	0.72						
BFB0405HHA	-A	-R00 / -F00	5	4.0 to 5.5	0.16	0.80	8500	0.085	3.00	14.33	0.564	34.5
BFB0412HHA	-A	-R00 / -F00	12	7.0 to 13.2	0.08	0.96						

* Function type is optional.
 * The max. air flow and the speed are measured in free air ; max. air pressure is measured at zero air flow.
 * Noise is measured in anechoic chamber in free air, one meter from intake side.
 * All readings are typical values at rated voltage.
 * Specifications are subject to change without notice.