

PRODUCT NUMBER SEE SHEET 2

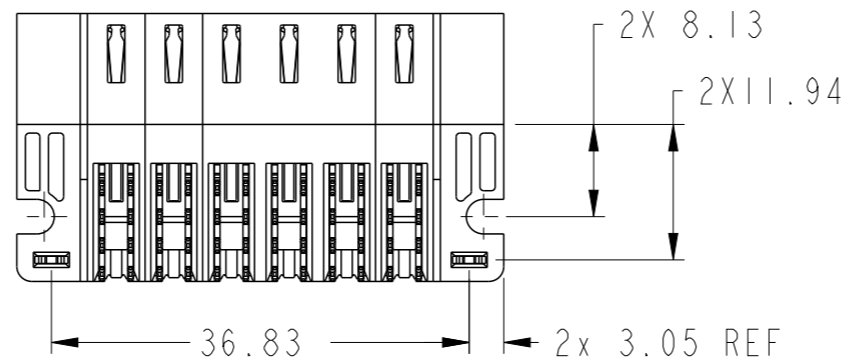

spec ref	*	dr	Jes Wu	2014/07/17	projection	MM	size	A3	scale	3:2
tolerance std	ASME Y14.5	eng	Rainbow Zhan	2014/08/15			ecn no		-	
TOLERANCES UNLESS OTHERWISE SPECIFIED		chr	Li-He	2014/08/14			rel level		Released	
surface	<input checked="" type="checkbox"/> linear <input type="checkbox"/> angular	appr	Pei-Ming Zheng	2014/08/15	product family		PwrBlade+		rel level	
ASME Y14.5	linear 0.X ±0.5 0.XX ±0.25 0.XXX ±0.10 angular 0° ±2°			title 6HDP RA PF HEADER		dwg no 10106133-6000001		rev A		
www.fci.com		cat. no.		Product - Customer Drw			sheet 1 of 3			

PRODUCT NO.	ROWS	HIGH POWER						E2	
		E1	P1	P2	P3	P4	P5		P6
10106133-6000001LF	DCBA	HA	HE	HE	HE	HE	HE	HE	HA

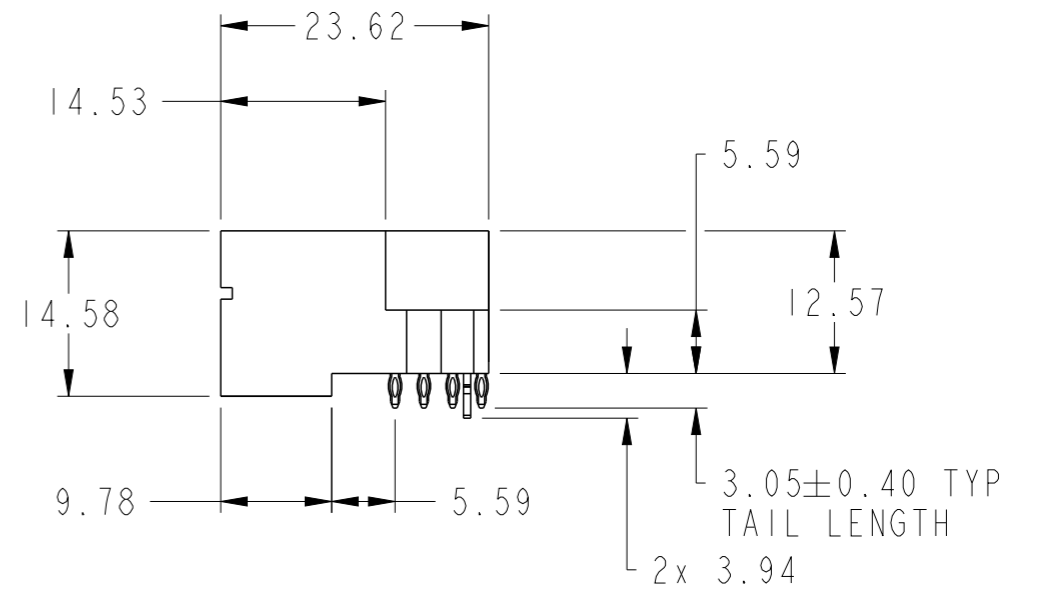
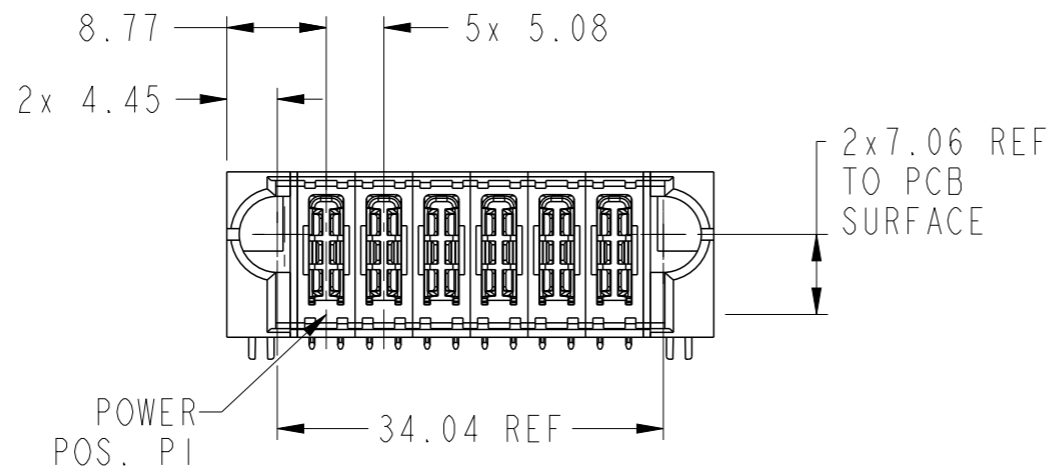
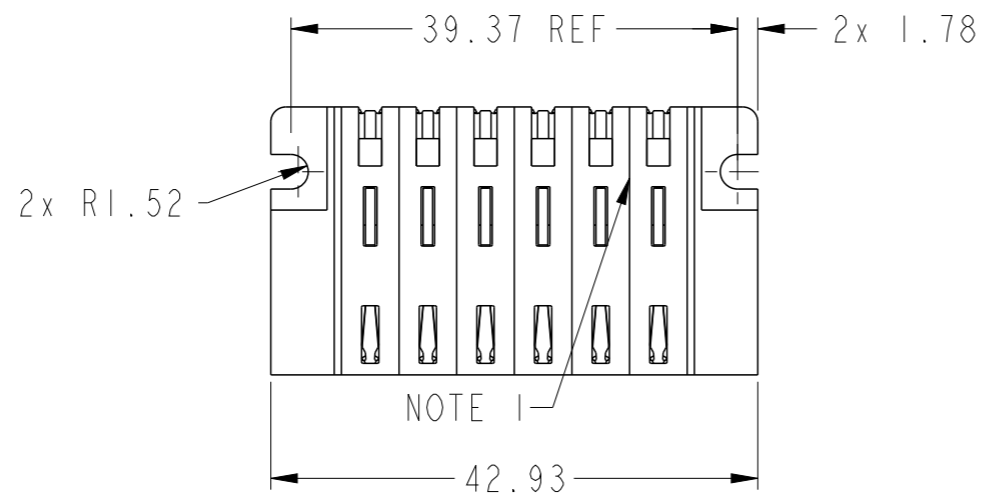
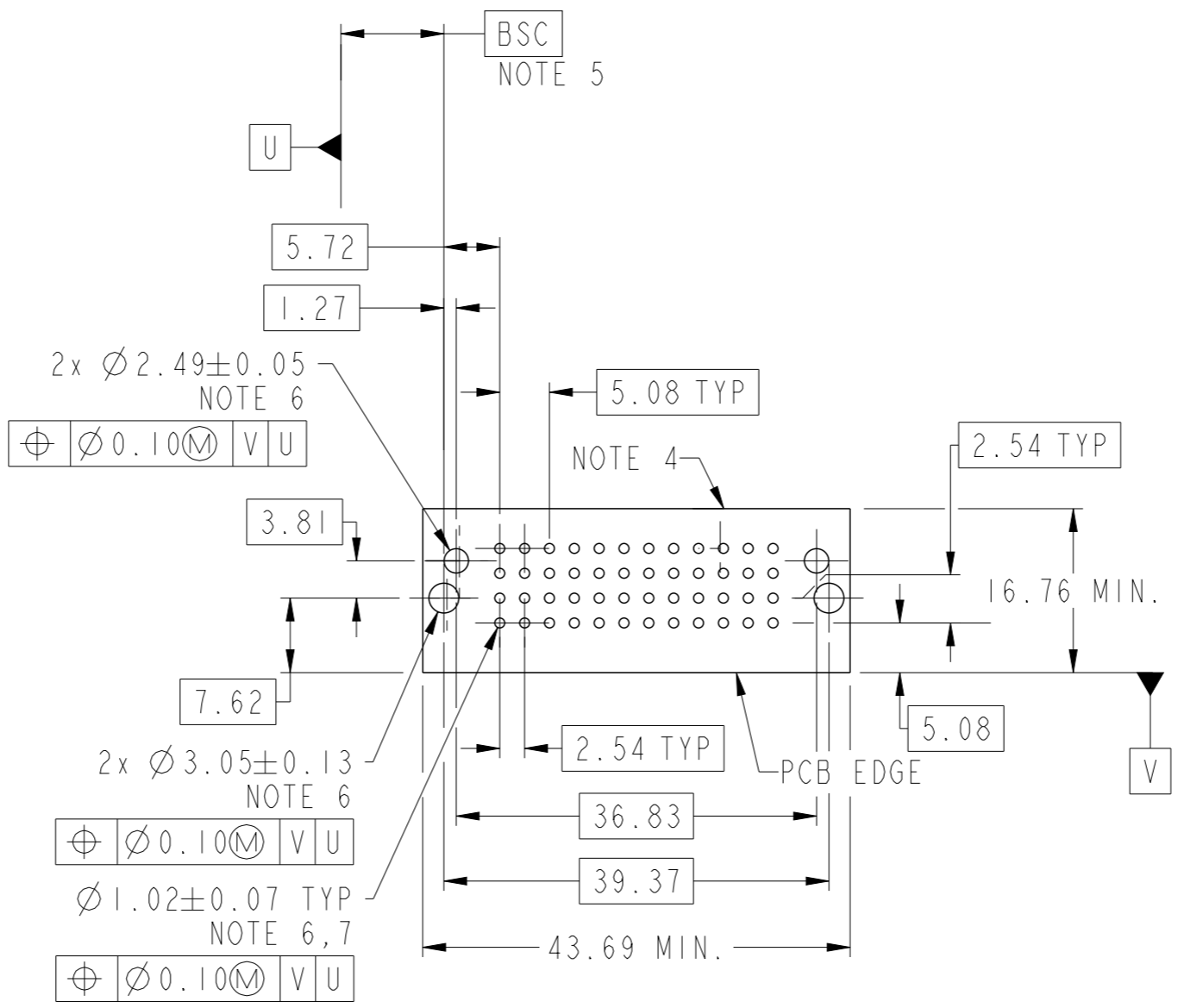

Copyright FCI.

CODE	DESCRIPTION
HA	METAL HOLD DOWN
HE	STD HIGH POWER CONTACT (3.05)



dr	Jes Wu	2014/07/17	projection MM ←→	size	A3	scale	3:2	
eng	Rainbow Zhan	2014/08/15		ecn no	-			
chr	Li-He	2014/08/14		rel level	Released			
appr	Pei-Ming Zheng	2014/08/15	product family	PwrBlade+				
www.fci.com		cat. no.	6HDP RA PF HEADER		dwg no	10106133-6000001	rev	A
Product - Customer Drw				sheet 2 of 3				

NOTES:

- 1) "FCI", PART NUMBER AND DATE CODE TO BE MARKED ON THIS SURFACE.  
THE MARK CAN BE OMITTED IF THERE IS NOT ENOUGH SPACE ON THIS SURFACE.
- 2) MATERIALS:  
-HOUSING - GLASS FILLED WITH HIGH TEMP THERMOPLASTIC, UL94V-0.  
-SIGNAL CONTACT - COPPER ALLOY.  
-POWER CONTACT - HIGH CONDUCTIVITY COPPER ALLOY.
- 3) PLATING SPECIFICATION REFER TO FCI 10116351
- 4) DENOTES CONNECTOR KEEP OUT ZONE.
- 5) DATUM AND BASIC DIMENSIONS WERE ESTABLISHED BY CUSTOMER.
- 6) ALL HOLE DIAMETERS ARE FINISHED HOLE SIZES.
- 7)  $1.15 \pm 0.025$ MM DRILLED HOLE PLATED WITH 0.00762MM MIN Sn  
OVER 0.0254-0.0762MM Cu PLATING TO ACHIEVE A  $1.02 \pm 0.07$ MM HOLE.
- 8) PRODUCT SPECIFICATION REFER TO FCI GS-12-658.  
APPLICATION SPECIFICATION REFER TO FCI GS-20-141.  
PRODUCT PACKAGED IN TRAYS, REFER TO FCI GS-14-1502.

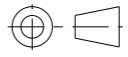
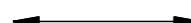

Copyright FCI.

dr	Jes Wu	2014/07/17	projection 	MM 	size	A3	scale	3:2
eng	Rainbow Zhan	2014/08/15			ecn no	-		
chr	Li-He	2014/08/14			product family	PwrBlade+	rel level	Released
appr	Pei-Ming Zheng	2014/08/15				title 6HDP RA PF HEADER	dwg no 10106133-6000001	rev A
www.fci.com			cat. no.	Product - Customer Drw		sheet 3 of 3		