

PLEASE CHECK WWW.MOLEX.COM FOR LATEST PART INFORMATION

Part Number: [0622021910](#)
Status: **Active**
Description: Modular Press In Tool, 4 Circuits

Documents:
[RoHS Certificate of Compliance \(PDF\)](#)

General

Product Family	Application Tooling
Series	T9999
Function	Insertion
Geographic Area	Global
Level of Automation	Manual
More Detailed Tech Information	applicationtooling@molex.com
Product Name	N/A
Tool Type	N/A
UPC	822348147953
Warranty Disclaimer	CAUTION: Molex tooling crimp specifications are valid only when used with Molex terminals and tooling manufactured by Molex and sold by Molex or authorized distributors ("Molex Tooling"). When using tooling other than Molex Tooling with Molex specific connector systems listed in our ATS documents, the Molex tooling qualification does not apply and the responsibility for full qualification of the connector system is that of the customer. Molex accepts no liability for connector performance or tooling support where tooling other than Molex Tooling is used or where Molex Tooling is modified.

Material Info

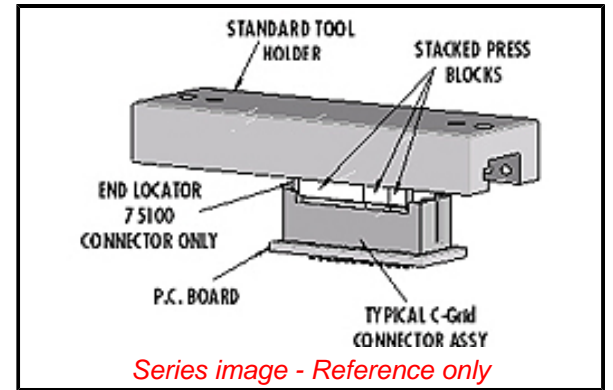

EU ELV

Not Reviewed

EU RoHS

Not Reviewed

REACH SVHC

Not Reviewed

Halogen-Free

Status

Not Reviewed

Need more information on product environmental compliance?

Email productcompliance@molex.com
Please visit the [Contact Us](#) section for any non-product compliance questions.

China ROHS

Not Reviewed

ELV

Not Reviewed

RoHS Phthalates

Not Reviewed

Search Parts in this Series

[T9999 Series](#)