

### Features

- 19 dB Gain
- 7 dB Noise Figure
- 8 V Bias
- Low Distortion
- Wide Bandwidth for DOCSIS 3.1
- Lead-Free 3 mm 16-lead PQFN Package
- Halogen-Free “Green” Mold Compound
- RoHS\* Compliant

### Description

The MAAM-011156 is a GaAs single stage differential amplifier assembled in a lead-free 3 mm 16-lead PQFN plastic package. This amplifier provides 19 dB of gain while biased at 8 volts and also offers a power down function. The amplifier provides excellent linearity and high output power with greater than 30 dB MER for 64 QAM modulation with 16 channels and 58 dBmV per channel.

It is ideally suited for use in CATV return path amplifier applications especially the wide bandwidth of DOCSIS 3.1.

### Ordering Information<sup>1,2</sup>

Part Number	Package
MAAM-011156-TR1000	1000 piece reel
MAAM-011156-TR3000	3000 piece reel
MAAM-011156-001SMB	Sample Board

1. Reference Application Note M513 for reel size information.
2. All sample boards include 5 loose parts.

\*Restrictions on Hazardous Substances,  
European Union Directive 2011/65/EU.

### Functional Schematic

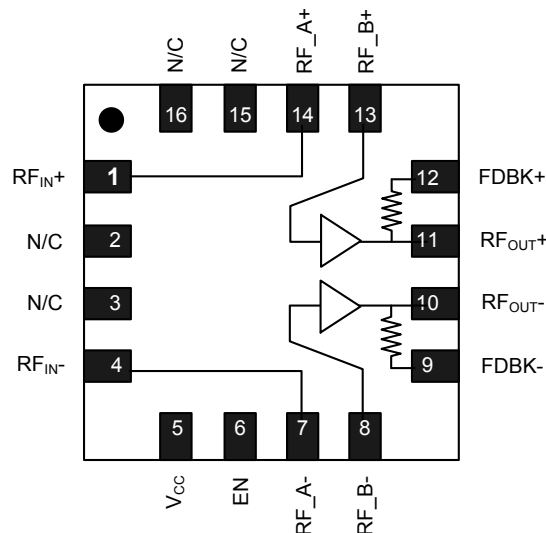

### Pin Designations

Pin	Function	Function
1	RF <sub>IN+</sub>	RF Input+
2	N/C	No Connection
3	N/C	No Connection
4	RF <sub>IN-</sub>	RF Input-
5	V <sub>CC</sub>	Bias Voltage
6	EN	Enable
7	RF <sub>A-</sub>	RF Input Node A-
8	RF <sub>B-</sub>	RF Input Node B-
9	FDBK-	Feedback-
10	RF <sub>OUT-</sub>	RF Output-
11	RF <sub>OUT+</sub>	RF Output+
12	FDBK+	Feedback+
13	RF <sub>B+</sub>	RF Input Node B+
14	RF <sub>A+</sub>	RF Input Node A+
15	N/C	No Connection
16	N/C	No Connection
17	Paddle <sup>3</sup>	Ground

3. The exposed paddle centered on the package bottom must be connected to RF and DC ground.

## Amplifier, CATV Return Path Differential 5 - 300 MHz

Rev. V3

**Electrical Specifications:  $T_A = 25^\circ\text{C}$ ,  $V_{CC} = 8\text{ V}$ ,  $EN = 5\text{ V}$**

Parameter	Test Conditions	Units	Min.	Typ.	Max.
Gain	-10 dBm $P_{IN}$ , 100 MHz -10 dBm $P_{IN}$ , 250 MHz	dB	18.5 18.0	19.5 19.5	21.5 21.0
Noise Figure	5 - 300 MHz	dB	—	7	—
Input Return Loss	5 - 300 MHz	dB	—	20	—
Output Return Loss	5 - 300 MHz	dB	—	18	—
Reverse Isolation	5 - 300 MHz	dB	—	26	—
64 QAM MER	16 Channels (5 - 250 MHz), 57 dBmV/Ch.	dBm	30	35	—
P1dB	5 - 300 MHz	dBm	—	28	—
OIP3	Two tones at 1 MHz spacing, $P_{OUT} = +12\text{ dBm}$ per tone, 200 MHz	dBm	—	44	—
OIP2	Two tones at 1 MHz spacing, $P_{OUT} = +12\text{ dBm}$ per tone, 5 - 300 MHz	dBm	—	78	—
$I_{CC}$	$V_{CC} = +8\text{ V}$ , $EN = 5\text{ V}$	mA	—	210	240
$I_{CC\_OFF}$	$V_{CC} = +8\text{ V}$ , $EN = 0\text{ V}$	mA	—	1	—

### Absolute Maximum Ratings<sup>4,5</sup>

Parameter	Absolute Maximum
Input Power	11 dBm
Bias Voltage	10 V
Junction Temperature <sup>6,7</sup>	+150°C
Operating Temperature	-40°C to +85°C
Storage Temperature	-65°C to +125°C

- Exceeding any one or combination of these limits may cause permanent damage to this device.
- MACOM does not recommend sustained operation near these survivability limits.
- Operating at nominal conditions with  $T_J \leq 150^\circ\text{C}$  will ensure  $MTTF > 1 \times 10^6$  hours.
- Junction Temperature ( $T_J$ ) =  $T_C + \Theta_{jc} * (V * I)$   
Typical thermal resistance ( $\Theta_{jc}$ ) = 16° CW.
  - For  $T_C = +25^\circ\text{C}$ ,  
 $T_J = 52^\circ\text{C}$  @ 8 V, 210 mA
  - For  $T_C = +85^\circ\text{C}$ ,  
 $T_J = 112^\circ\text{C}$  @ 8 V, 210 mA

### Handling Procedures

Please observe the following precautions to avoid damage:

### Static Sensitivity

Gallium Arsenide Integrated Circuits are sensitive to electrostatic discharge (ESD) and can be damaged by static electricity. Proper ESD control techniques should be used when handling these HBM Class 1B devices.

## Schematic PCB Layout

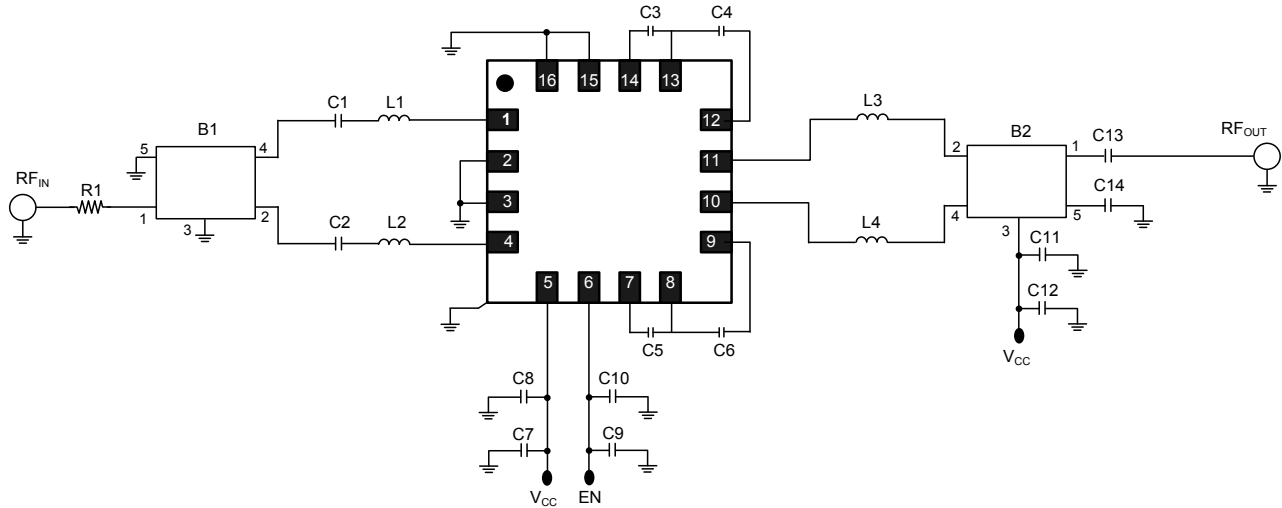

## Sample Board

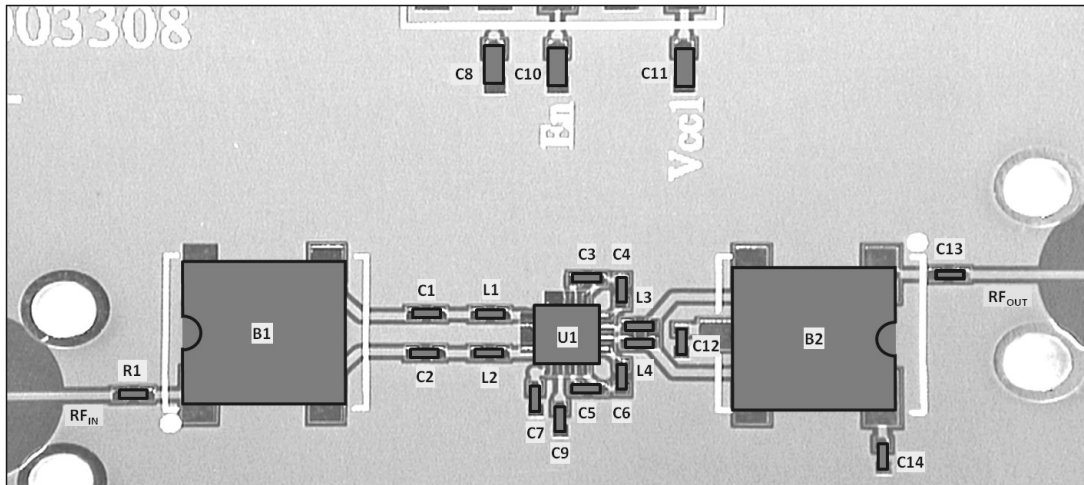

## Off-Chip Component Values

Component	Value	Package
C1 - C6, C13	0.01 $\mu$ F	0402
C7, C9, C12, C14	0.1 $\mu$ F	0402
C8, C10, C11	1 $\mu$ F	0603
R1	0 $\Omega$	0402
L1 - L4	18 nH	0402
B1 - B2	1:2 Transformer Balun, MACOM's MABA-011029	

## Typical Performance Curves

**Gain**

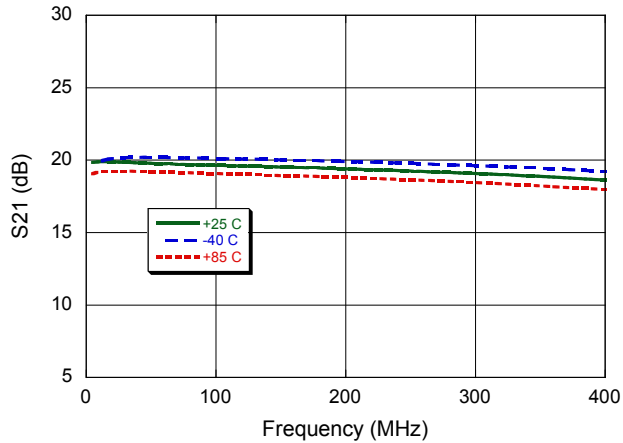

**Reverse Isolation**

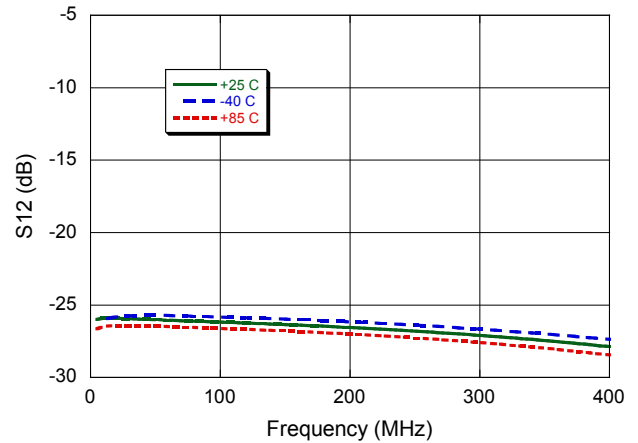

**Input Return Loss**

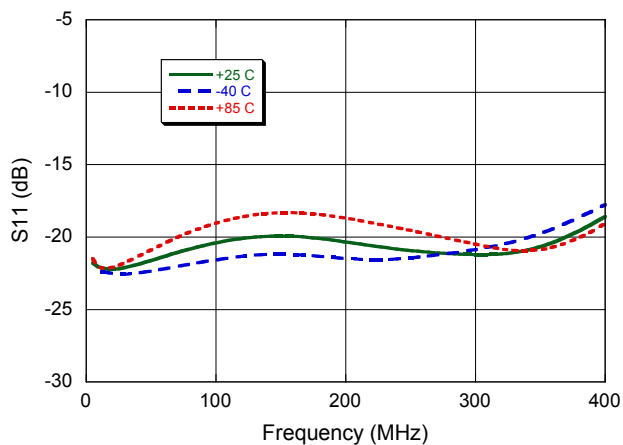

**Output Return Loss**

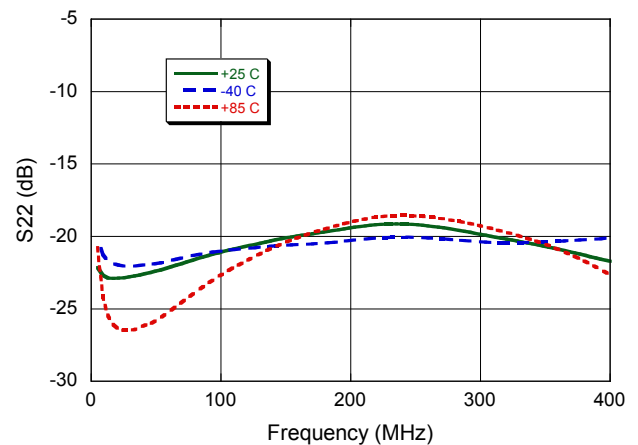

**Noise Figure**

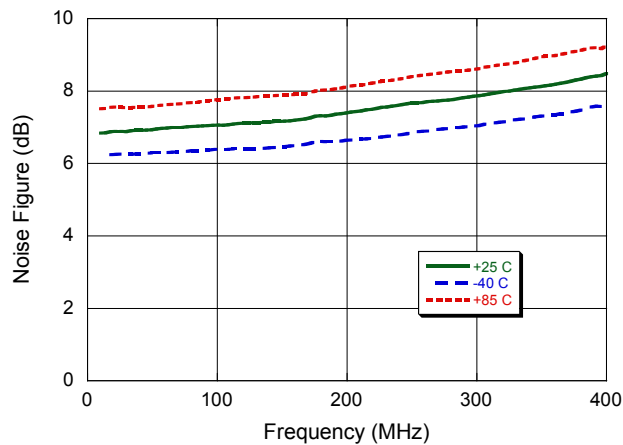

## Typical Performance Curves

**OIP2 @  $P_{OUT} = 12$  dBm**

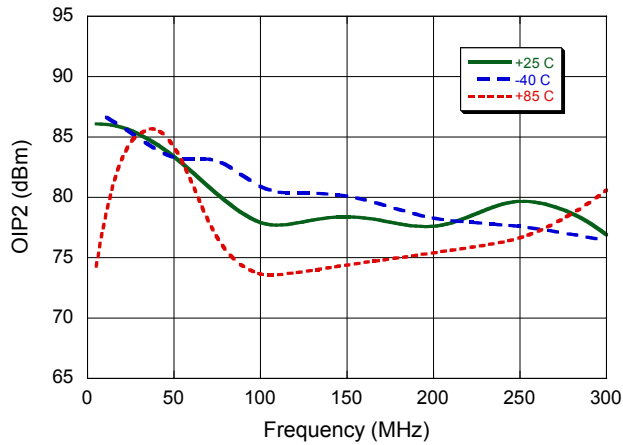

**OIP3 @  $P_{OUT} = 12$  dBm**

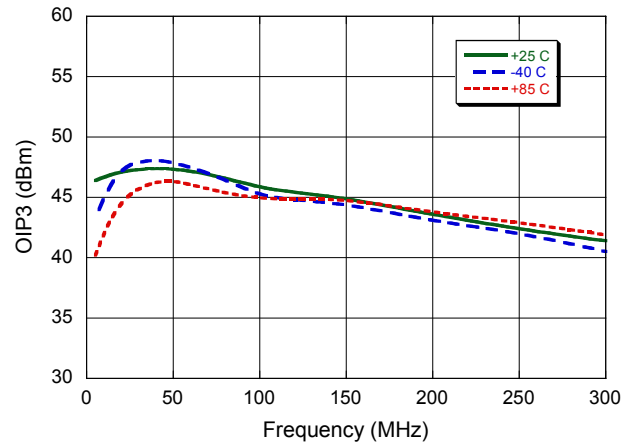

**P1dB @ 250 MHz**

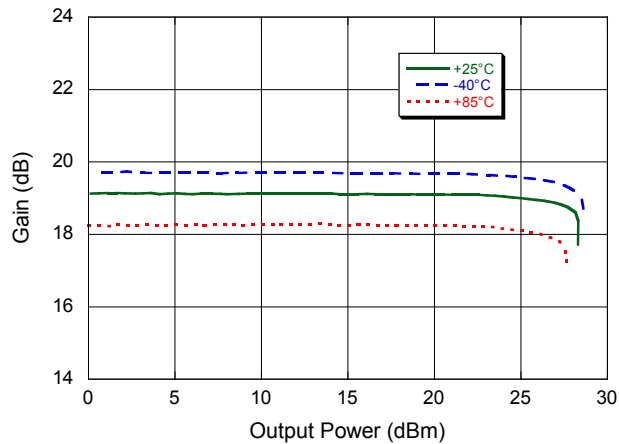

**64 QAM Modulation Error Ratio<sup>8</sup>**

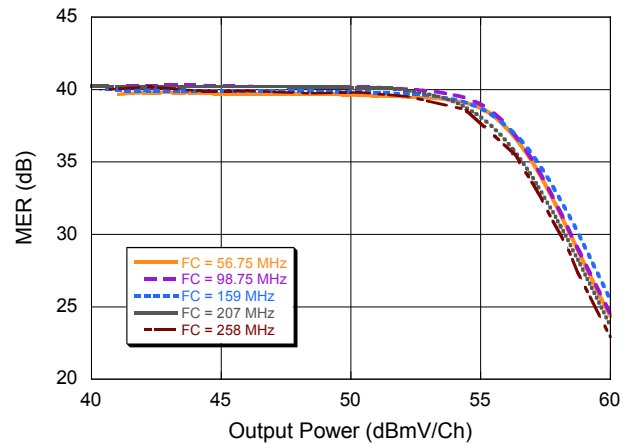

8. Fc is the carrier frequency for 9th of 16 contiguous 6 MHz 64 QAM channels. MER measured on 9th channel.

## Lead-Free 3 mm 16-Lead PQFN†

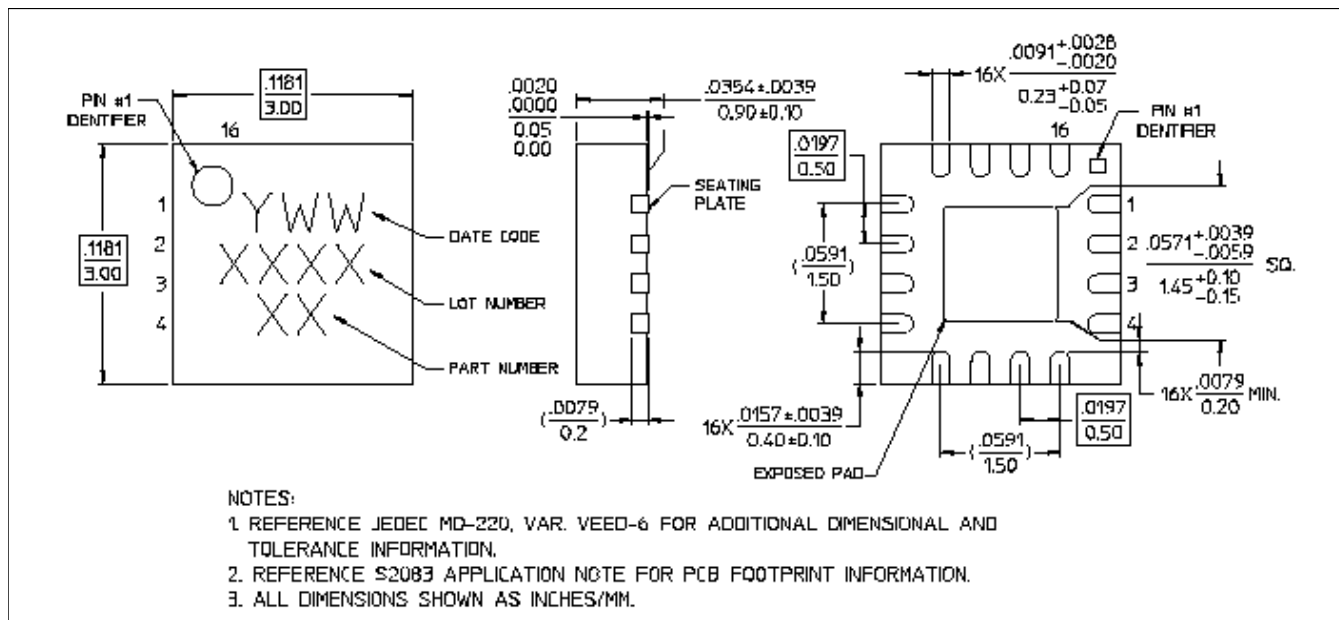

† Reference Application Note S2083 for lead-free solder reflow recommendations.  
 Meets JEDEC moisture sensitivity level 1 requirements.  
 Plating is 100% matte tin over copper.

## Applications Section - 15 dB and 10 dB Gain

### Schematic PCB Layout

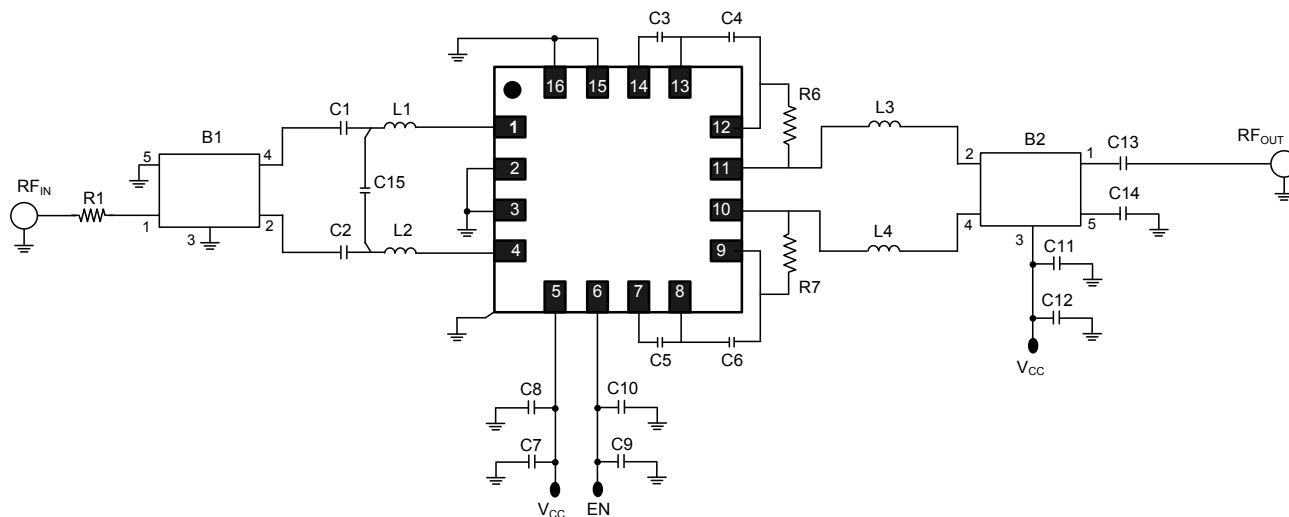

### Off-Chip Component Values Parts List

#### 15 dB Gain

Component	Value	Package
C1 - C6, C13	0.01 $\mu$ F	0402
C7, C9, C12, C14	0.1 $\mu$ F	0402
C8, C10, C11	1 $\mu$ F	0603
C15	6.2 pF	0402
L1, L2	18 nH	0402
L3, L4	0 $\Omega$	0402
R1	0 $\Omega$	0402
R6, R7	560 $\Omega$	0402
B1 - B2	1:1 Transformer Balun, MACOM's MABA-009572	

#### 10 dB Gain

Component	Value	Package
C1 - C6, C13	0.01 $\mu$ F	0402
C7, C9, C12, C14	0.1 $\mu$ F	0402
C8, C10, C11	1 $\mu$ F	0603
C15	4 pF	0402
L1, L2	4.7 nH	0402
L3, L4	0 $\Omega$	0402
R1	0 $\Omega$	0402
R6, R7	160 $\Omega$	0402
B1 - B2	1:1 Transformer Balun, MACOM's MABA-009572	

## Applications Section - 15 dB Gain Curves

**Gain @ 15 dB**

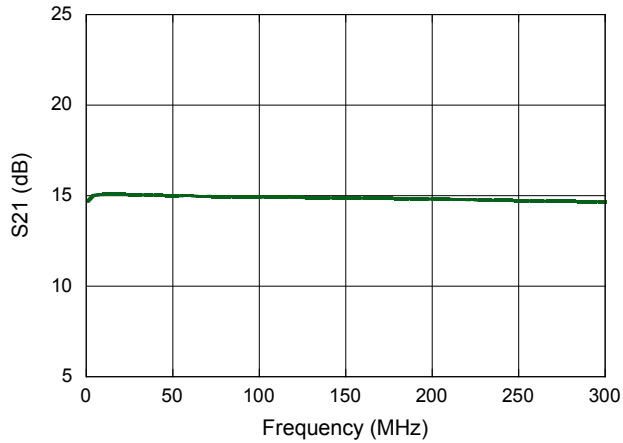

**Reverse Isolation with 15 dB Gain**

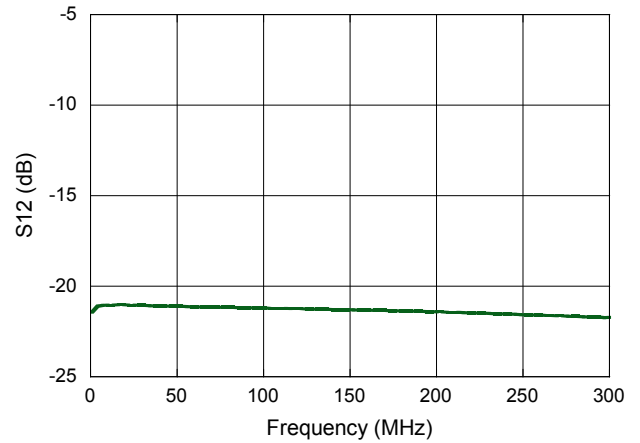

**Input Return Loss with 15 dB Gain**

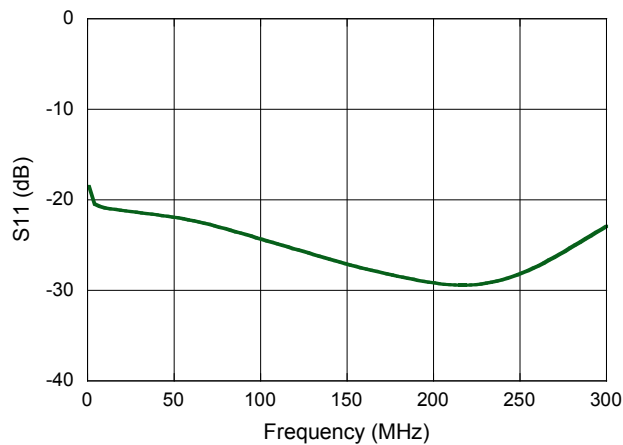

**Output Return Loss with 15 dB Gain**

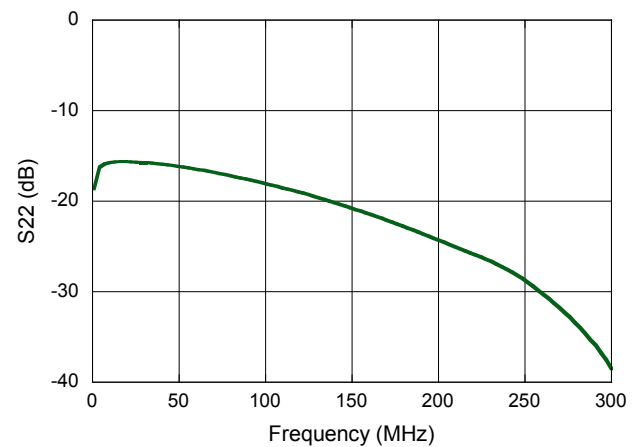

**Noise Figure with 15 dB Gain**

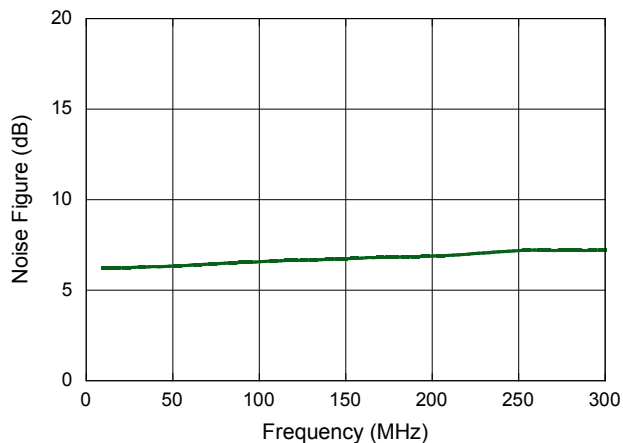



## Applications Section - 10 dB Gain Curves

**Gain @ 10 dB**

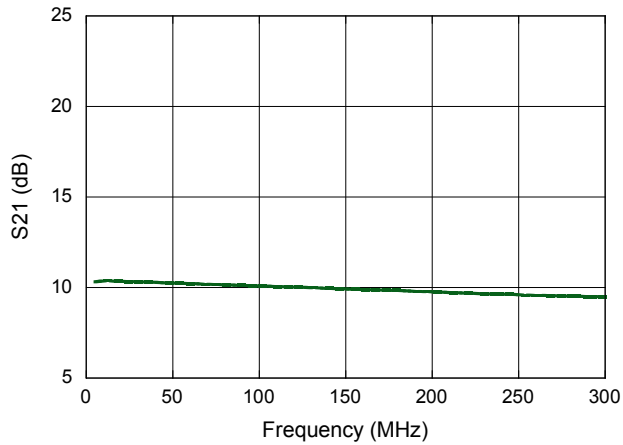

**Reverse Isolation with 10 dB Gain**

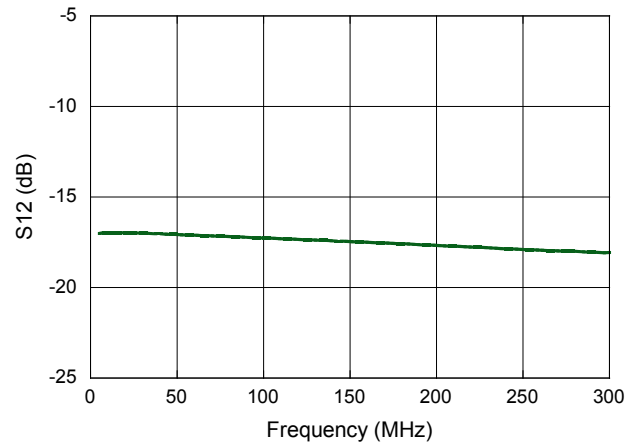

**Input Return Loss with 10 dB Gain**

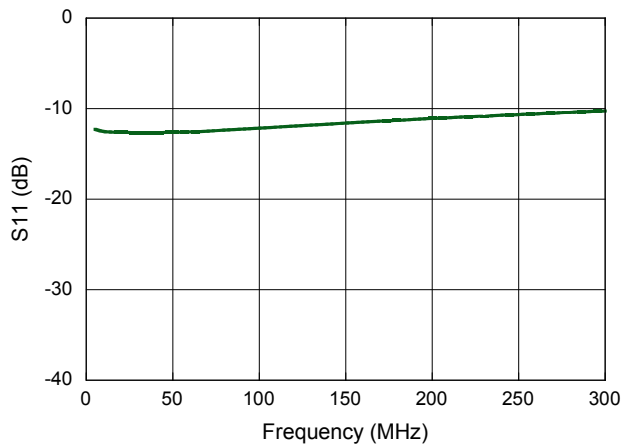

**Output Return Loss with 10 dB Gain**

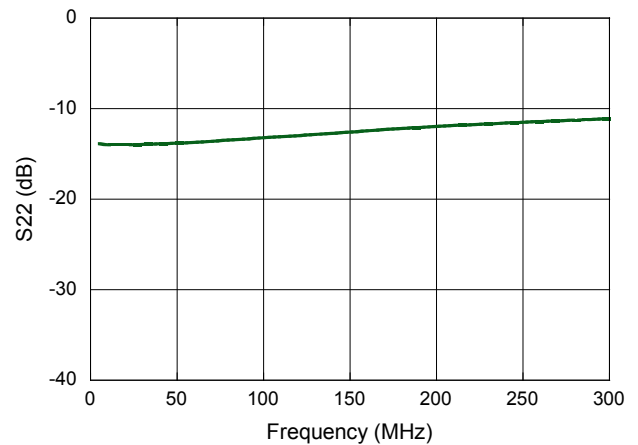

**Noise Figure with 10 dB Gain**

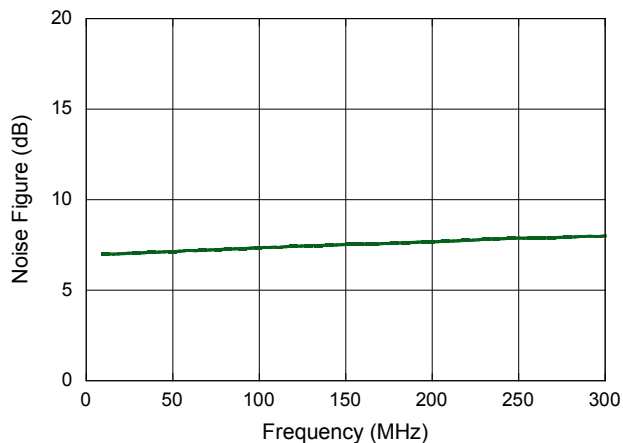

M/A-COM Technology Solutions Inc. All rights reserved.

Information in this document is provided in connection with M/A-COM Technology Solutions Inc ("MACOM") products. These materials are provided by MACOM as a service to its customers and may be used for informational purposes only. Except as provided in MACOM's Terms and Conditions of Sale for such products or in any separate agreement related to this document, MACOM assumes no liability whatsoever. MACOM assumes no responsibility for errors or omissions in these materials. MACOM may make changes to specifications and product descriptions at any time, without notice. MACOM makes no commitment to update the information and shall have no responsibility whatsoever for conflicts or incompatibilities arising from future changes to its specifications and product descriptions. No license, express or implied, by estoppel or otherwise, to any intellectual property rights is granted by this document.

THESE MATERIALS ARE PROVIDED "AS IS" WITHOUT WARRANTY OF ANY KIND, EITHER EXPRESS OR IMPLIED, RELATING TO SALE AND/OR USE OF MACOM PRODUCTS INCLUDING LIABILITY OR WARRANTIES RELATING TO FITNESS FOR A PARTICULAR PURPOSE, CONSEQUENTIAL OR INCIDENTAL DAMAGES, MERCHANTABILITY, OR INFRINGEMENT OF ANY PATENT, COPYRIGHT OR OTHER INTELLECTUAL PROPERTY RIGHT. MACOM FURTHER DOES NOT WARRANT THE ACCURACY OR COMPLETENESS OF THE INFORMATION, TEXT, GRAPHICS OR OTHER ITEMS CONTAINED WITHIN THESE MATERIALS. MACOM SHALL NOT BE LIABLE FOR ANY SPECIAL, INDIRECT, INCIDENTAL, OR CONSEQUENTIAL DAMAGES, INCLUDING WITHOUT LIMITATION, LOST REVENUES OR LOST PROFITS, WHICH MAY RESULT FROM THE USE OF THESE MATERIALS.

MACOM products are not intended for use in medical, lifesaving or life sustaining applications. MACOM customers using or selling MACOM products for use in such applications do so at their own risk and agree to fully indemnify MACOM for any damages resulting from such improper use or sale.