

LOW PROFILE THREE FLANGE 6VA POWER TRANSFORMER APPROVED TO UL506

MODEL NUMBER
PFT6-38

A. Electrical Specifications (@ 25°C)

1. Input Voltage and Frequency; 115/230V 50/60Hz
2. Output Voltage; 17.5VCT ±5% @ 0.155A
37.5VCT ±5% @ 0.060A
3. Output Power; 6VA
4. Insulation Resistance;
100MΩ MIN @ 500VDC, Pri to Sec, Pri to Core, Sec to Core
5. Hi-Pot;
1500Vrms 1 minute @ Pri to Sec, Pri to Core
1500Vrms 1 minute @ Sec to Core

B. Marking; PFT6-38, MICROTRAN, date code, country of origin, terminal numbers and safety symbols.

C. Safety:
UL506 General Purpose
File Number E79781

D. Schematic Diagram:

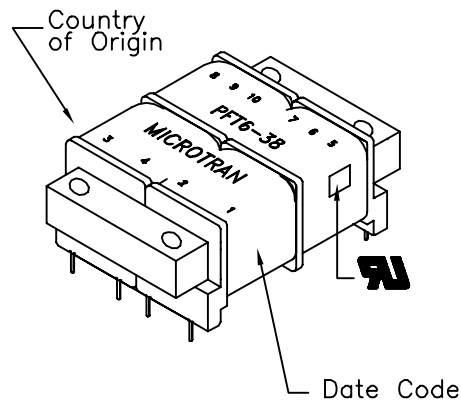
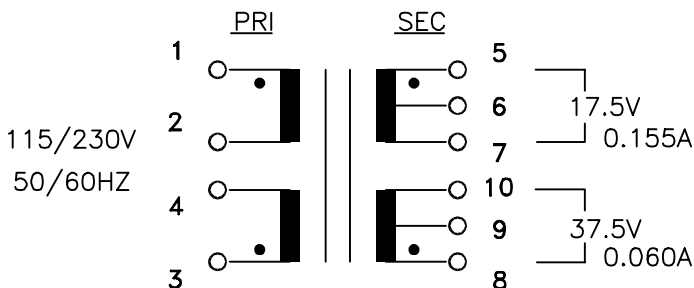

E. Mechanical Specifications:

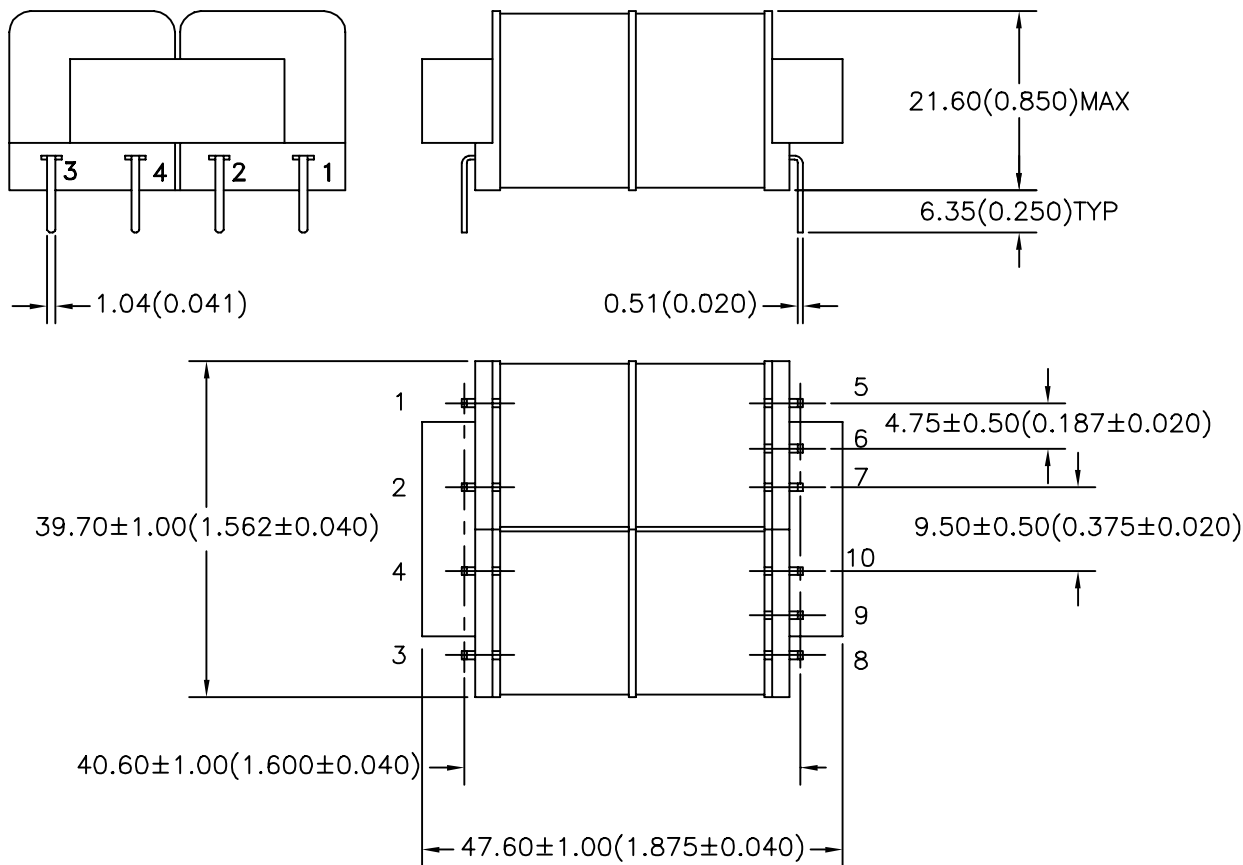

PREPARED BY:

D. Rund

ENGINEER:

T. Shiozawa

QUALITY CONTROL:

D. Kelley

APPROVED:

J. Coleman

DWG CONTROL NO.
P-A1-12325
ACAD\3FVA1123251.DWG

REV
-

3 FLANGE BOBBIN
POWER TRANSFORMER

TAMURA CORPORATION OF AMERICA
43352 BUSINESS PARK DRIVE, TEMECULA, CA. 92590-6624
(909) 699-1270 FAX 9096769482

PFT6-38

MODEL SPECIFICATION

DIM: mm(In) SCL: NONE SH: 1 OF 1

PROPRIETARY NOTICE: THIS DRAWING PRINT OR DOCUMENT AND SUBJECT MATTER DISCLOSED HEREIN ARE PROPRIETARY ITEMS TO WHICH TAMURA RETAINS THE EXCLUSIVE RIGHT OF DISSEMINATION, REPRODUCTION, MANUFACTURE AND SALE. THIS DRAWING, PRINT OR DOCUMENT IS SUBMITTED IN CONFIDENCE FOR CONSIDERATION BY THE RECIPIENT ALONE UNLESS PERMISSION FOR FURTHER DISCLOSURE IS EXPRESSLY GRANTED IN WRITING.