

## Trench gate field-stop IGBT, M series 650 V, 6 A low loss

Datasheet - production data

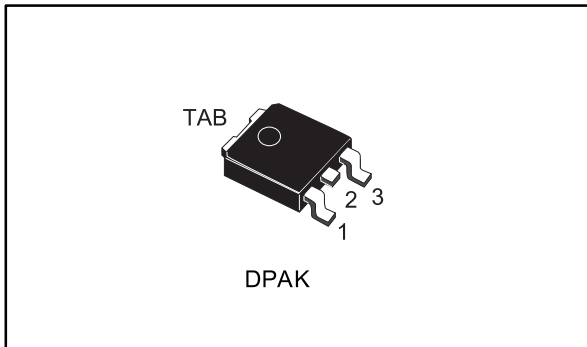
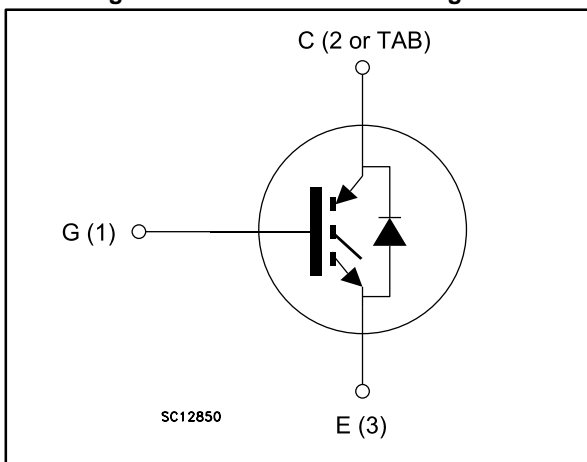

Figure 1: Internal schematic diagram



### Features

- 6  $\mu$ s of short-circuit withstand time
- $V_{CE(sat)} = 1.55$  V (typ.) @  $I_c = 6$  A
- Tight parameter distribution
- Safer paralleling
- Low thermal resistance
- Soft and very fast recovery antiparallel diode

### Applications

- Motor control
- UPS
- PFC

### Description

This device is an IGBT developed using an advanced proprietary trench gate field-stop structure. The device is part of the M series IGBTs, which represent an optimal balance between inverter system performance and efficiency where low-loss and short-circuit functionality are essential. Furthermore, the positive  $V_{CE(sat)}$  temperature coefficient and tight parameter distribution result in safer paralleling operation.

Table 1: Device summary

Order code	Marking	Package	Packing
STGD6M65DF2	G6M65DF2	DPAK	Tape and reel

---

## Contents

<b>1</b>	<b>Electrical ratings .....</b>	<b>3</b>
<b>2</b>	<b>Electrical characteristics .....</b>	<b>4</b>
	2.1 Electrical characteristics (curves).....	7
<b>3</b>	<b>Test circuits .....</b>	<b>12</b>
<b>4</b>	<b>Package information .....</b>	<b>13</b>
	4.1 DPAK (TO-252) type A2 package information.....	14
	4.2 DPAK (TO-252) packing information.....	17
<b>5</b>	<b>Revision history .....</b>	<b>19</b>

# 1 Electrical ratings

**Table 2: Absolute maximum ratings**

Symbol	Parameter	Value	Unit
$V_{CES}$	Collector-emitter voltage ( $V_{GE} = 0$ V)	650	V
$I_C$	Continuous collector current at $T_C = 25$ °C	12	A
	Continuous collector current at $T_C = 100$ °C	6	A
$I_{CP}^{(1)}$	Pulsed collector current	24	A
$V_{GE}$	Gate-emitter voltage	$\pm 20$	V
$I_F$	Continuous forward current at $T_C = 25$ °C	12	A
	Continuous forward current at $T_C = 100$ °C	6	A
$I_{FP}^{(1)}$	Pulsed forward current	24	A
$P_{TOT}$	Total dissipation at $T_C = 25$ °C	88	W
$T_{STG}$	Storage temperature range	- 55 to 150	°C
$T_J$	Operating junction temperature range	- 55 to 175	°C

**Notes:**

<sup>(1)</sup>Pulse width limited by maximum junction temperature.

**Table 3: Thermal data**

Symbol	Parameter	Value	Unit
$R_{thJC}$	Thermal resistance junction-case IGBT	1.7	°C/W
$R_{thJC}$	Thermal resistance junction-case diode	5	°C/W
$R_{thJA}$	Thermal resistance junction-ambient	100	°C/W

## 2 Electrical characteristics

$T_C = 25\text{ °C}$  unless otherwise specified

**Table 4: Static characteristics**

Symbol	Parameter	Test conditions	Min.	Typ.	Max.	Unit
$V_{(BR)CES}$	Collector-emitter breakdown voltage	$V_{GE} = 0\text{ V}$ , $I_C = 250\text{ }\mu\text{A}$	650			V
$V_{CE(sat)}$	Collector-emitter saturation voltage	$V_{GE} = 15\text{ V}$ , $I_C = 6\text{ A}$		1.55	2.0	V
		$V_{GE} = 15\text{ V}$ , $I_C = 6\text{ A}$ , $T_J = 125\text{ °C}$		1.9		
		$V_{GE} = 15\text{ V}$ , $I_C = 6\text{ A}$ , $T_J = 175\text{ °C}$		2.1		
$V_F$	Forward on-voltage	$I_F = 6\text{ A}$		2.2		V
		$I_F = 6\text{ A}$ , $T_J = 125\text{ °C}$		2.0		
		$I_F = 6\text{ A}$ , $T_J = 175\text{ °C}$		1.9		
$V_{GE(th)}$	Gate threshold voltage	$V_{CE} = V_{GE}$ , $I_C = 250\text{ }\mu\text{A}$	5	6	7	V
$I_{CES}$	Collector cut-off current	$V_{GE} = 0\text{ V}$ , $V_{CE} = 650\text{ V}$			25	$\mu\text{A}$
$I_{GES}$	Gate-emitter leakage current	$V_{CE} = 0\text{ V}$ , $V_{GE} = \pm 20\text{ V}$			$\pm 250$	$\mu\text{A}$

**Table 5: Dynamic characteristics**

Symbol	Parameter	Test conditions	Min.	Typ.	Max.	Unit
$C_{ies}$	Input capacitance	$V_{CE} = 25\text{ V}$ , $f = 1\text{ MHz}$ , $V_{GE} = 0\text{ V}$	-	530	-	pF
$C_{oes}$	Output capacitance		-	31	-	
$C_{res}$	Reverse transfer capacitance		-	11	-	
$Q_g$	Total gate charge	$V_{CC} = 520\text{ V}$ , $I_C = 6\text{ A}$ , $V_{GE} = 15\text{ V}$ (see <a href="#">Figure 30: "Gate charge test circuit"</a> )	-	21.2	-	nC
$Q_{ge}$	Gate-emitter charge		-	5.2	-	
$Q_{gc}$	Gate-collector charge		-	8.8	-	

Table 6: IGBT switching characteristics (inductive load)

Symbol	Parameter	Test conditions	Min.	Typ.	Max.	Unit
$t_{d(on)}$	Turn-on delay time	$V_{CE} = 400\text{ V}$ , $I_C = 6\text{ A}$ , $V_{GE} = 15\text{ V}$ , $R_G = 22\ \Omega$ (see <a href="#">Figure 29: "Test circuit for inductive load switching"</a> )		15	-	ns
$t_r$	Current rise time			5.8	-	ns
$(di/dt)_{on}$	Turn-on current slope			828	-	A/ $\mu$ s
$t_{d(off)}$	Turn-off-delay time			90	-	ns
$t_f$	Current fall time			130	-	ns
$E_{on(1)}$	Turn-on switching energy			0.036	-	mJ
$E_{off(2)}$	Turn-off switching energy			0.200	-	mJ
$E_{ts}$	Total switching energy			0.236	-	mJ
$t_{d(on)}$	Turn-on delay time	$V_{CE} = 400\text{ V}$ , $I_C = 6\text{ A}$ , $V_{GE} = 15\text{ V}$ , $R_G = 22\ \Omega$ , $T_J = 175\text{ }^\circ\text{C}$ (see <a href="#">Figure 29: "Test circuit for inductive load switching"</a> )		17	-	ns
$t_r$	Current rise time			7	-	ns
$(di/dt)_{on}$	Turn-on current slope			685	-	A/ $\mu$ s
$t_{d(off)}$	Turn-off-delay time			86	-	ns
$t_f$	Current fall time			205	-	ns
$E_{on(1)}$	Turn-on switching energy			0.064	-	mJ
$E_{off(2)}$	Turn-off switching energy			0.290	-	mJ
$E_{ts}$	Total switching energy			0.354	-	mJ
$t_{sc}$	Short-circuit withstand time	$V_{CC} \leq 400\text{ V}$ , $V_{GE} = 15\text{ V}$ , $T_{Jstart} = 150\text{ }^\circ\text{C}$	6		-	$\mu$ s
		$V_{CC} \leq 400\text{ V}$ , $V_{GE} = 13\text{ V}$ , $T_{Jstart} = 150\text{ }^\circ\text{C}$	10		-	$\mu$ s

**Notes:**

(1) Turn-on switching energy includes reverse recovery of the diode.

(2) Turn-off switching energy also includes the tail of the collector current.

Table 7: Diode switching characteristics (inductive load)

Symbol	Parameter	Test conditions	Min.	Typ.	Max.	Unit
$t_{rr}$	Reverse recovery time	$I_F = 6\text{ A}$ , $V_R = 400\text{ V}$ , $V_{GE} = 15\text{ V}$ (see <a href="#">Figure 29: "Test circuit for inductive load switching"</a> ) $di/dt = 1000\text{ A}/\mu\text{s}$	-	140	-	ns
$Q_{rr}$	Reverse recovery charge		-	210	-	nC
$I_{rrm}$	Reverse recovery current		-	6.6	-	A
$dl_{rr}/dt$	Peak rate of fall of reverse recovery current during $t_b$		-	430	-	A/ $\mu\text{s}$
$E_{rr}$	Reverse recovery energy		-	16	-	$\mu\text{J}$
$t_{rr}$	Reverse recovery time	$I_F = 6\text{ A}$ , $V_R = 400\text{ V}$ , $V_{GE} = 15\text{ V}$ $T_J = 175\text{ }^\circ\text{C}$ (see <a href="#">Figure 29: "Test circuit for inductive load switching"</a> ) $di/dt = 1000\text{ A}/\mu\text{s}$	-	200	-	ns
$Q_{rr}$	Reverse recovery charge		-	473	-	nC
$I_{rrm}$	Reverse recovery current		-	9.6	-	A
$dl_{rr}/dt$	Peak rate of fall of reverse recovery current during $t_b$		-	428	-	A/ $\mu\text{s}$
$E_{rr}$	Reverse recovery energy		-	32	-	$\mu\text{J}$

2.1 Electrical characteristics (curves)

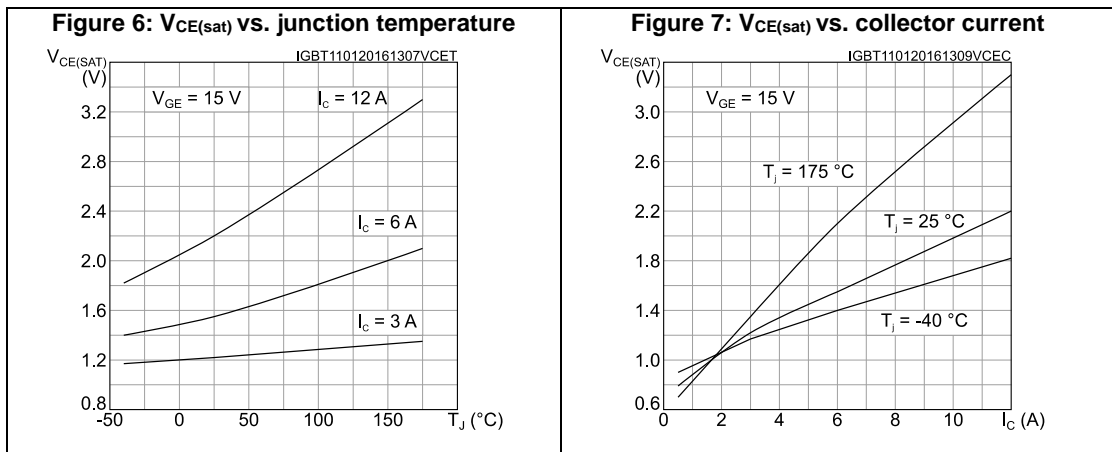
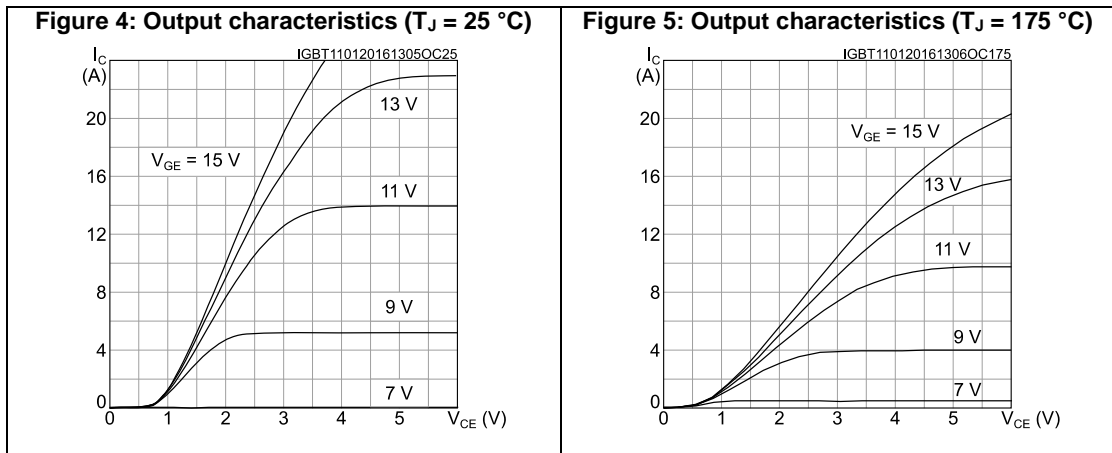
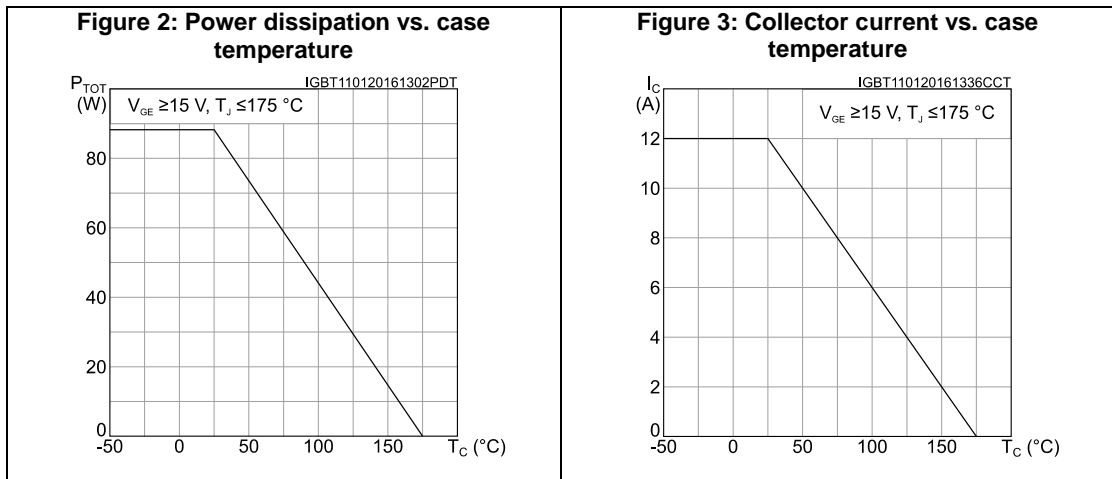

**Figure 8: Collector current vs. switching frequency**

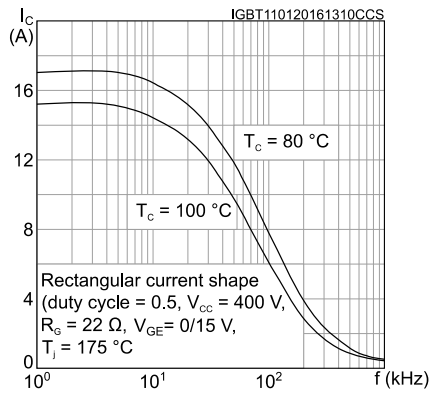

**Figure 9: Forward bias safe operating area**

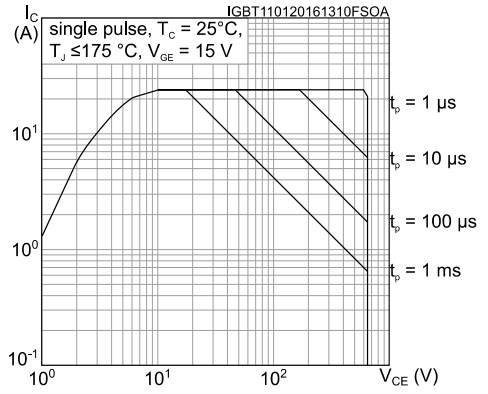

**Figure 10: Transfer characteristics**

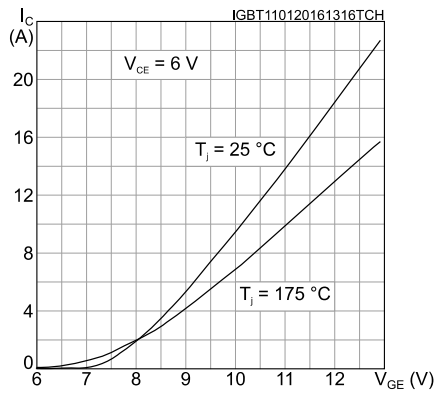

**Figure 11: Diode V\_F vs. forward current**

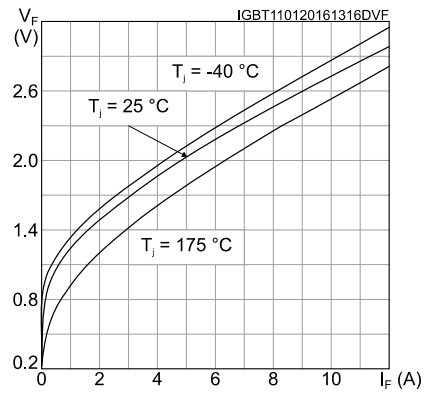

**Figure 12: Normalized V\_GE(th) vs. junction temperature**

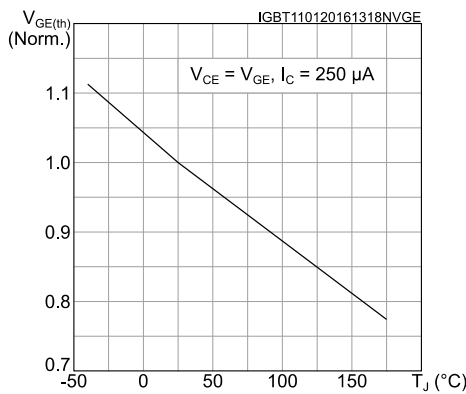

**Figure 13: Normalized V\_(BR)CES vs. junction temperature**

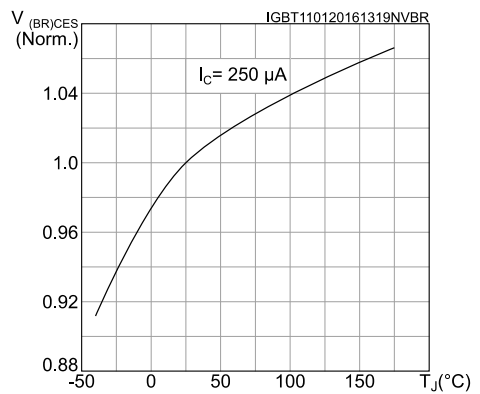



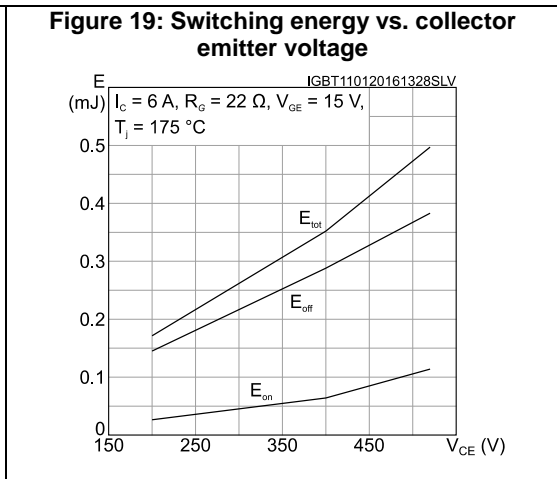
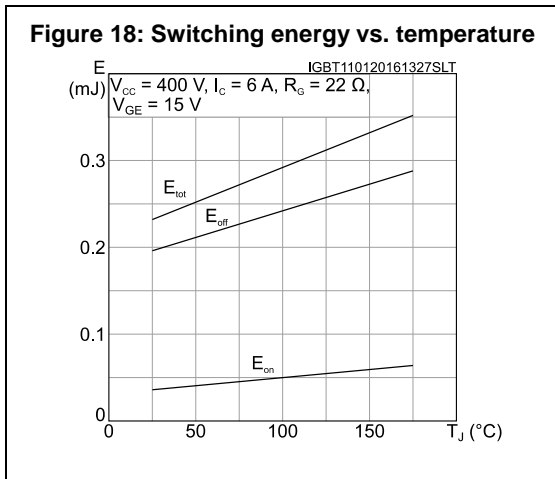
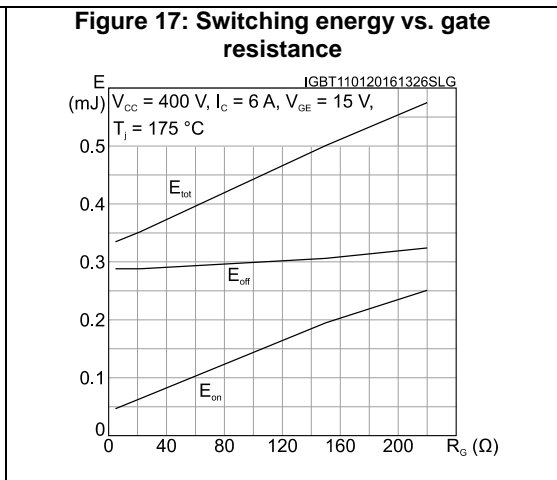
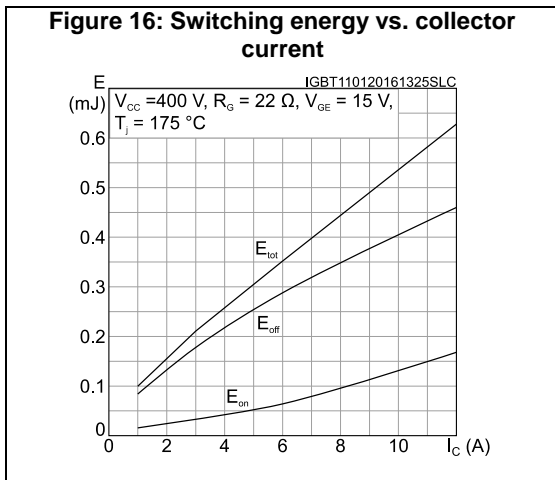
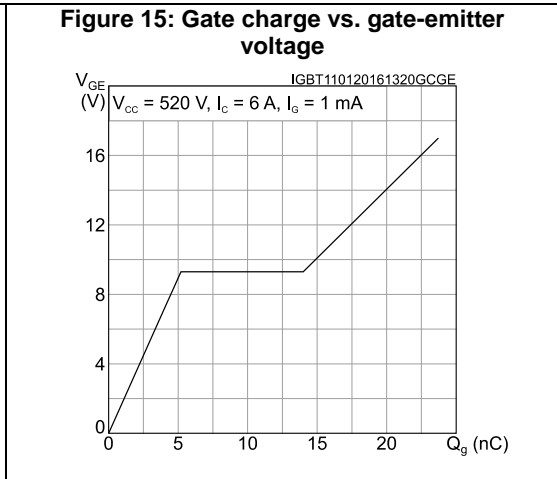
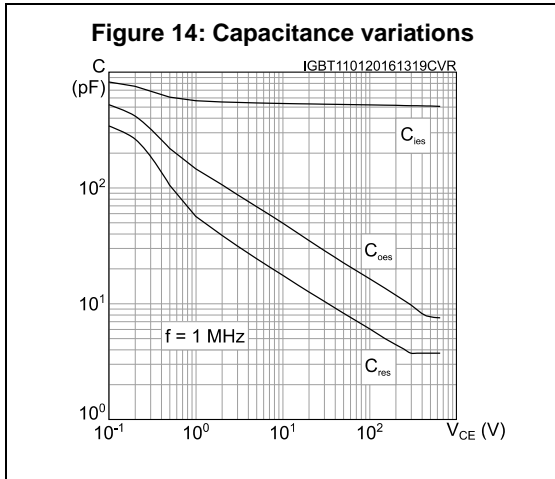

Figure 20: Short-circuit time and current vs.  $V_{GE}$

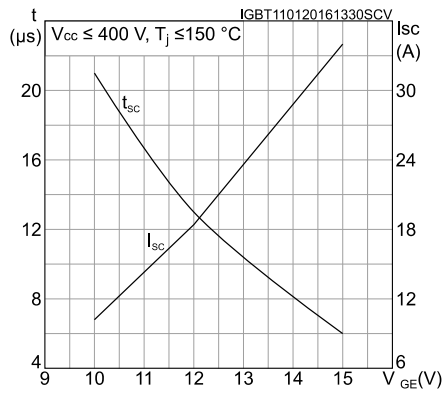

Figure 21: Switching times vs. collector current

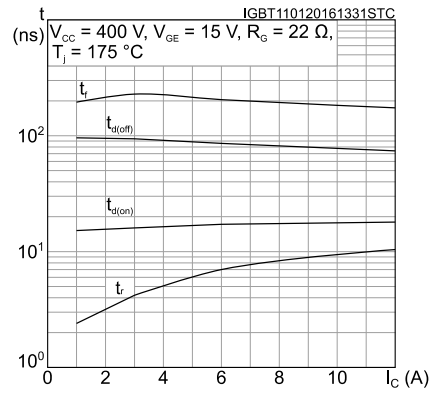

Figure 22: Switching times vs. gate resistance

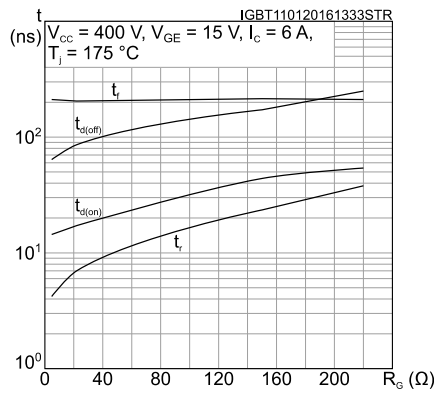

Figure 23: Reverse recovery current vs. diode current slope

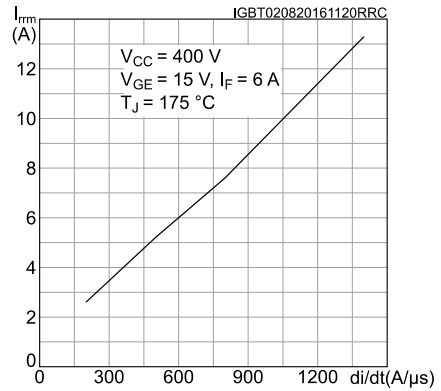

Figure 24: Reverse recovery time vs. diode current slope

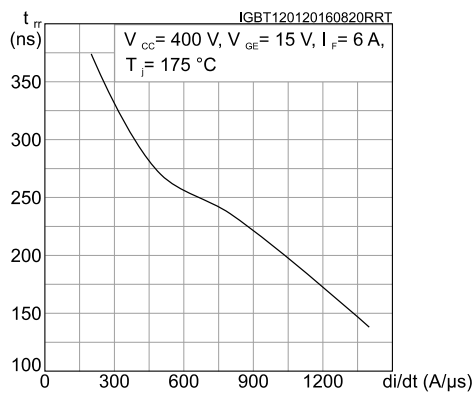

Figure 25: Reverse recovery charge vs. diode current slope

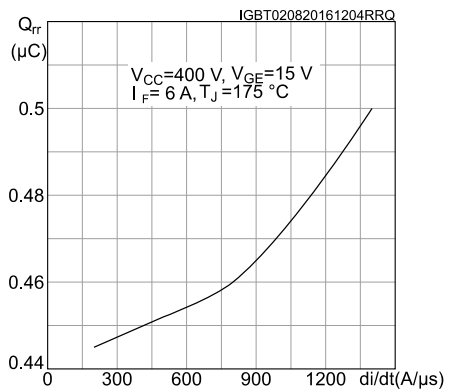

Figure 26: Reverse recovery energy vs. diode current slope

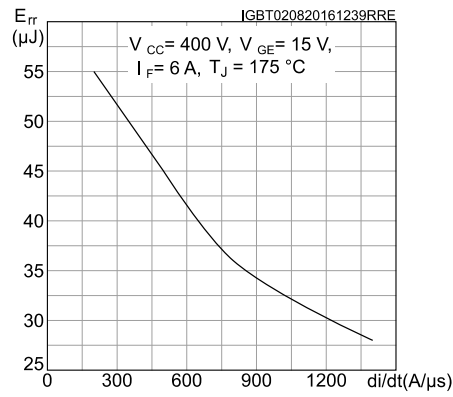

Figure 27: Thermal impedance for IGBT

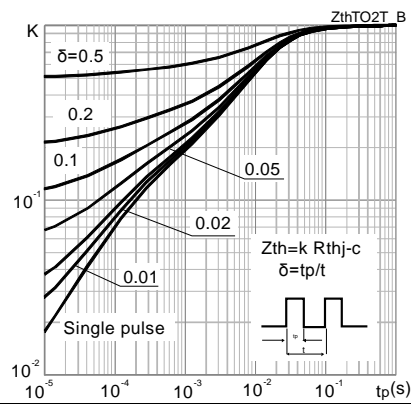
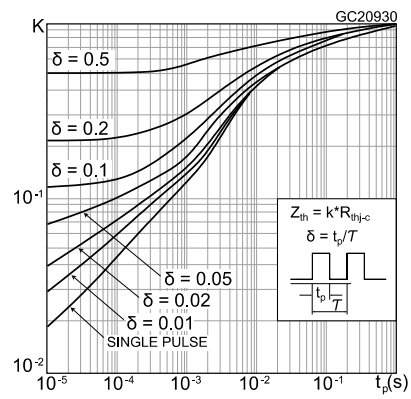
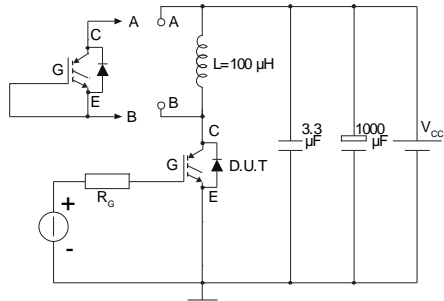

Figure 28: Thermal impedance for diode



### 3 Test circuits

**Figure 29: Test circuit for inductive load switching**



AM01504v1

**Figure 30: Gate charge test circuit**

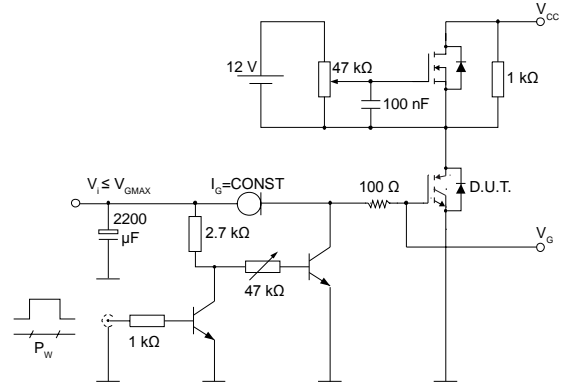

AM01505v1

**Figure 31: Switching waveform**

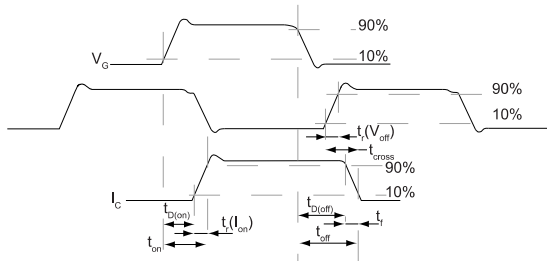

AM01506v1

**Figure 32: Diode reverse recovery waveform**

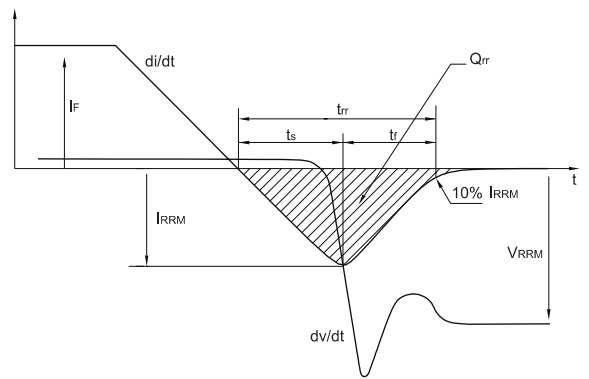

AM01507v1

## 4 Package information

In order to meet environmental requirements, ST offers these devices in different grades of ECOPACK® packages, depending on their level of environmental compliance. ECOPACK® specifications, grade definitions and product status are available at: [www.st.com](http://www.st.com). ECOPACK® is an ST trademark.

### 4.1 DPAK (TO-252) type A2 package information

Figure 33: DPAK (TO-252) type A2 package outline

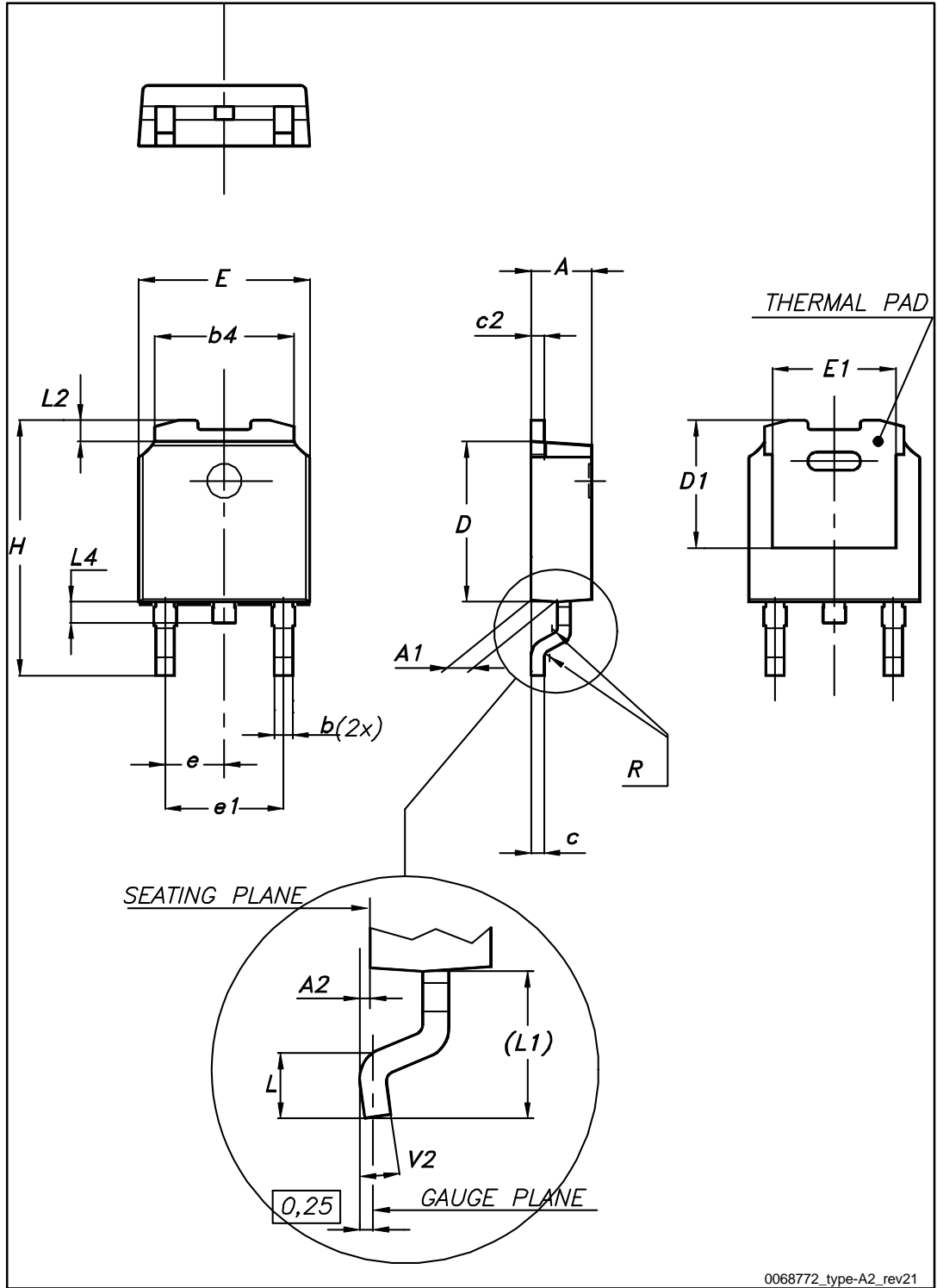
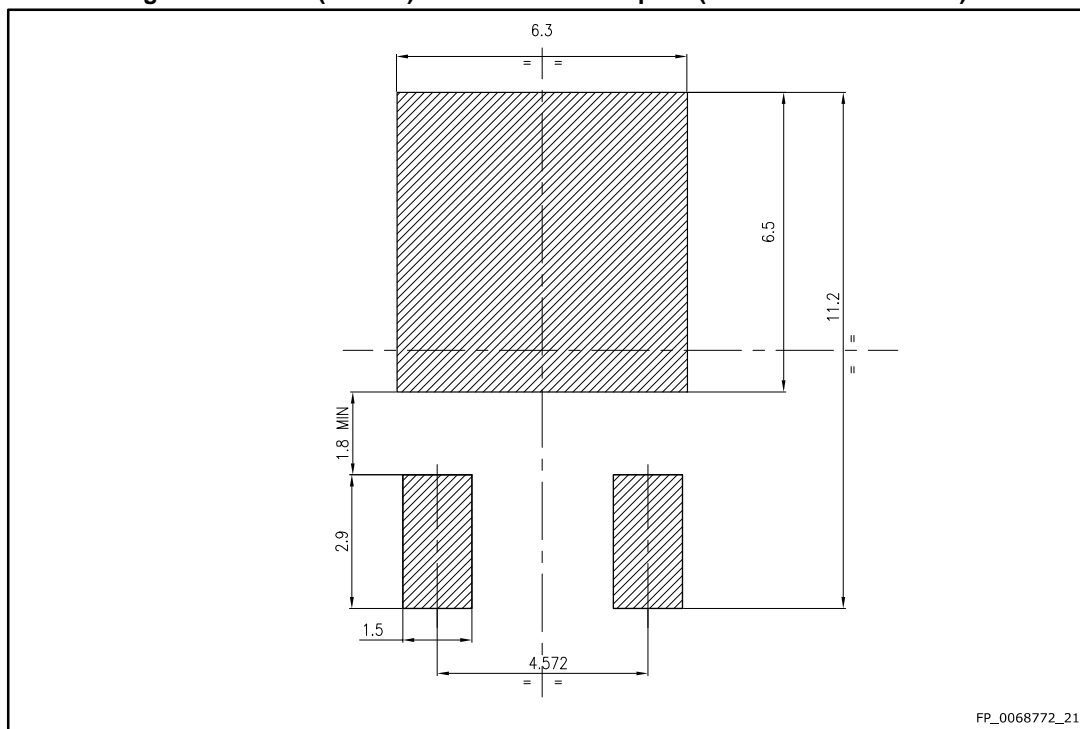

Table 8: DPAK (TO-252) type A2 mechanical data

Dim.	mm		
	Min.	Typ.	Max.
A	2.20		2.40
A1	0.90		1.10
A2	0.03		0.23
b	0.64		0.90
b4	5.20		5.40
c	0.45		0.60
c2	0.48		0.60
D	6.00		6.20
D1	4.95	5.10	5.25
E	6.40		6.60
E1	5.10	5.20	5.30
e	2.16	2.28	2.40
e1	4.40		4.60
H	9.35		10.10
L	1.00		1.50
L1	2.60	2.80	3.00
L2	0.65	0.80	0.95
L4	0.60		1.00
R		0.20	
V2	0°		8°

Figure 34: DPAK (TO-252) recommended footprint (dimensions are in mm)





### 4.2 DPAK (TO-252) packing information

Figure 35: DPAK (TO-252) tape outline

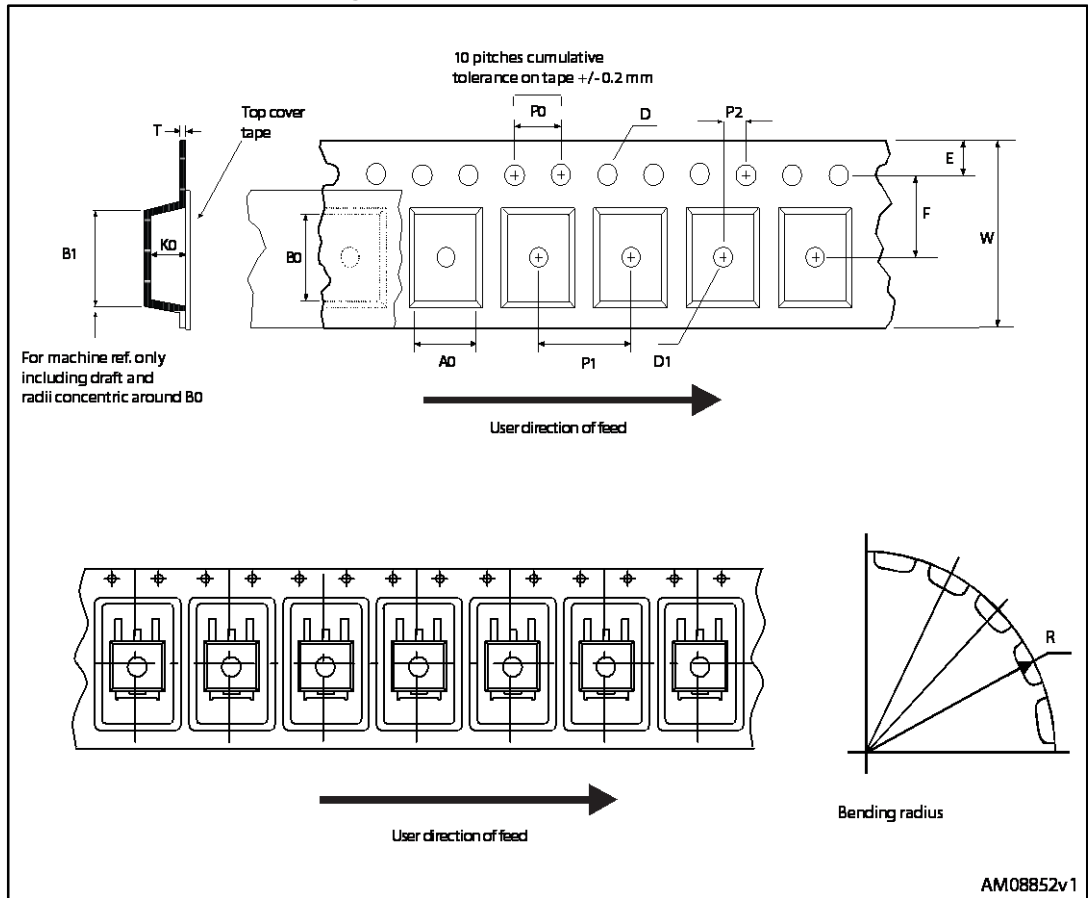

Figure 36: DPAK (TO-252) reel outline

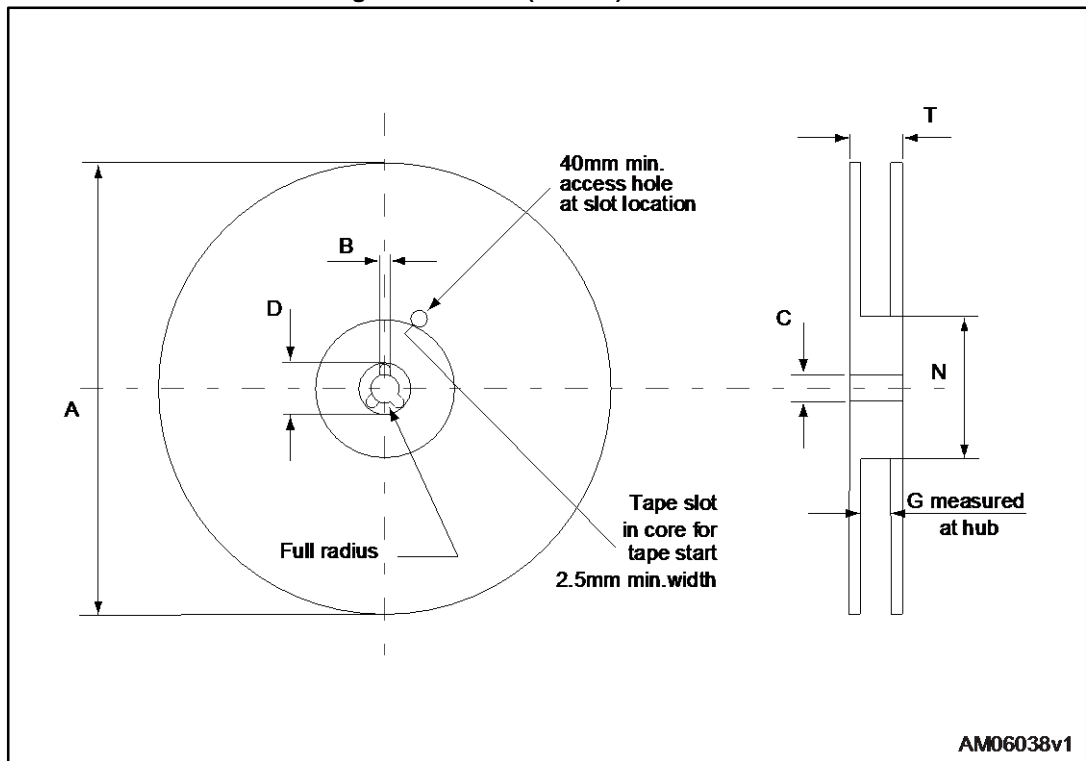

Table 9: DPAK (TO-252) tape and reel mechanical data

Tape			Reel		
Dim.	mm		Dim.	mm	
	Min.	Max.		Min.	Max.
A0	6.8	7	A		330
B0	10.4	10.6	B	1.5	
B1		12.1	C	12.8	13.2
D	1.5	1.6	D	20.2	
D1	1.5		G	16.4	18.4
E	1.65	1.85	N	50	
F	7.4	7.6	T		22.4
K0	2.55	2.75			
P0	3.9	4.1	Base qty.		2500
P1	7.9	8.1	Bulk qty.		2500
P2	1.9	2.1			
R	40				
T	0.25	0.35			
W	15.7	16.3			

## 5 Revision history

Table 10: Document revision history

Date	Revision	Changes
30-Nov-2015	1	First release.
13-Jan-2016	2	Modified: <i>Table 4: "Static characteristics"</i> , <i>Table 5: "Dynamic characteristics"</i> , <i>Table 6: "IGBT switching characteristics (inductive load)"</i> and <i>Table 7: "Diode switching characteristics (inductive load)"</i> Added: <i>Section 2.1: "Electrical characteristics (curves)"</i> Minor text changes
04-Aug-2016	3	Updated: <i>Table 2: "Absolute maximum ratings"</i> , <i>Table 4: "Static characteristics"</i> , <i>Table 6: "IGBT switching characteristics (inductive load)"</i> , <i>Table 7: "Diode switching characteristics (inductive load)"</i> . Updated <i>Figure 9: "Forward bias safe operating area"</i> , <i>Figure 12: "Normalized VGE(th) vs. junction temperature"</i> , <i>Figure 20: "Short-circuit time and current vs. VGE"</i> , <i>Figure 23: "Reverse recovery current vs. diode current slope"</i> . Changed: <i>Figure 25: "Reverse recovery charge vs. diode current slope"</i> , and <i>Figure 26: "Reverse recovery energy vs. diode current slope"</i> . Document status promoted from preliminary to production data.

**IMPORTANT NOTICE – PLEASE READ CAREFULLY**

STMicroelectronics NV and its subsidiaries ("ST") reserve the right to make changes, corrections, enhancements, modifications, and improvements to ST products and/or to this document at any time without notice. Purchasers should obtain the latest relevant information on ST products before placing orders. ST products are sold pursuant to ST's terms and conditions of sale in place at the time of order acknowledgement.

Purchasers are solely responsible for the choice, selection, and use of ST products and ST assumes no liability for application assistance or the design of Purchasers' products.

No license, express or implied, to any intellectual property right is granted by ST herein.

Resale of ST products with provisions different from the information set forth herein shall void any warranty granted by ST for such product.

ST and the ST logo are trademarks of ST. All other product or service names are the property of their respective owners.

Information in this document supersedes and replaces information previously supplied in any prior versions of this document.

© 2016 STMicroelectronics – All rights reserved