

SPECIFICATION

- Part No. : **FW.90.SMA.M**
- Product Name : Flexible Whip Monopole Antenna
LTE / Cellular / CDMA Antenna For
4G/3G/2G Applications
698~960MHz 1710~2690Mhz
- Features : IP67
Robust Inner Steel Core
SMA(M) Connector
RoHS Compliant✓



FW.90 Whip
Mounted on a
Bracket – WM.90



FW.90 SMA(M)
Connector



1. Introduction

The FW.90 is a flexible cellular whip antenna with IP67 housing. It has a wide response and high peak gain. Ideal for outdoor environments which require high gain, on both lower and upper bands. It's unique characteristic is it has stable above 2dBi peak gain on all five common 2G/3G GSM/CDMA cellular bands used worldwide (when attached to a 30cm*30cm metal plate). The antenna radiates best attached to a metal plate but it can still perform without as evidenced by the table below.

For a waterproof integration to a metal box a waterproof panel mount SMA connector or cable assembly can be provided. TNC and N type antenna versions also available.

The FW.90 can be used with a Wall Mounting Bracket, and we have designed an L Shaped Bracket for use with the Whip Antenna, the part number for this option is [WM.90.A305111](#). Testing of the whip antenna on the bracket, in free-space, and on a reference ground-plane has been done to show the benefit of the L-bracket.

This antenna delivers wider coverage areas and more reliable connections for professional customers in the automotive, industrial industries. The whip is made up of a flexible inner steel core covered by TPU so extremely resistant to collisions and maintaining its original shape and RF performance. The whip and the connection internally to the bracket is completely IP67 waterproof.

The bracket allows complete concealment of the cable for a more secure integration and cleaner installation. The cable can also be routed out of the back wall of the bracket into the interior of the mounting wall for added security against vandalism. The standard version comes with 3M extremely low loss CFD200 (0.3dB against 0.7dB for RG58) to allow for flexibility of placement.

Customized frequency and gain versions can be supplied.

2. Specification

ELECTRICAL							
Frequency (MHz)	698 ~798	824 ~896	880 ~960	1710 ~1880	1850 ~1990	1710 ~2170	2570 ~2690
Peak Gain (dBi)							
Free Space	-2.11	-1.30	-0.27	2.45	3.35	2.83	3.45
On 30cm*30cm GND	-2.75	-0.84	2.02	4.65	5.09	4.55	4.65
L - Bracket	-1.11	2.53	1.80	1.81	2.23	2.22	1.80
Average Gain (dBi)							
Free Space	-6.30	-5.33	-4.59	-1.85	-1.51	-1.73	-2.13
On 30cm*30cm GND	-5.76	-4.62	-3.03	-1.73	-1.44	-1.69	-1.84
L - Bracket	-5.58	-2.33	-2.44	-2.71	-3.03	-2.75	-2.88
Efficiency (%)							
Free Space	23.49	29.32	35.08	65.41	70.84	67.30	61.58
On 30cm*30cm GND	26.60	34.93	50.32	67.30	71.81	67.94	65.54
L - Bracket	27.92	58.66	57.15	53.86	49.86	53.24	51.59
Return Loss (dB)	<-3	<-6	<-4	<-5	<-5	<-6	<-6
Impedance	50Ω						
Polarization	Linear						
Radiation Pattern	Omni						
Input Power	2 W						
MECHANICAL							
Dimensions	Height 248 ± 5 mm						
Base Diameter	17.08 ± 0.2 mm						
Whip Diameter	4 ± 0.2 mm						
Casing	ABS						
Connector	SMA Male						
Weight	420g						
ENVIRONMENTAL							
Temperature Range	-40°C to 85°C						
Humidity	Non-condensing 65°C 95% RH						

LTE BANDS			
Band Number	LTE / LTE-Advanced / WCDMA / HSPA / HSPA+ / TD-SCDMA		
	Uplink	Downlink	Covered
1	UL: 1920 to 1980	DL: 2110 to 2170	✓
2	UL: 1850 to 1910	DL: 1930 to 1990	✓
3	UL: 1710 to 1785	DL: 1805 to 1880	✓
4	UL: 1710 to 1755	DL: 2110 to 2155	✓
5	UL: 824 to 849	DL: 869 to 894	✓
7	UL: 2500 to 2570	DL: 2620 to 2690	✓
8	UL: 880 to 915	DL: 925 to 960	✓
9	UL: 1749.9 to 1784.9	DL: 1844.9 to 1879.9	✓
11	UL: 1427.9 to 1447.9	DL: 1475.9 to 1495.9	✓
12	UL: 699 to 716	DL: 729 to 746	✓
13	UL: 777 to 787	DL: 746 to 756	✓
14	UL: 788 to 798	DL: 758 to 768	✓
17	UL: 704 to 716	DL: 734 to 746 (LTE only)	✓
18	UL: 815 to 830	DL: 860 to 875 (LTE only)	✓
19	UL: 830 to 845	DL: 875 to 890	✓
20	UL: 832 to 862	DL: 791 to 821	✓
21	UL: 1447.9 to 1462.9	DL: 1495.9 to 1510.9	✗
22	UL: 3410 to 3490	DL: 3510 to 3590	✗
23	UL: 2000 to 2020	DL: 2180 to 2200 (LTE only)	✓
24	UL: 1625.5 to 1660.5	DL: 1525 to 1559 (LTE only)	✓
25	UL: 1850 to 1915	DL: 1930 to 1995	✓
26	UL: 814 to 849	DL: 859 to 894	✓
27	UL: 807 to 824	DL: 852 to 869 (LTE only)	✓
28	UL: 703 to 748	DL: 758 to 803 (LTE only)	✓
29	UL: -	DL: 717 to 728 (LTE only)	✓
30	UL: 2305 to 2315	DL: 2350 to 2360 (LTE only)	✓
31	UL: 452.5 to 457.5	DL: 462.5 to 467.5 (LTE only)	✗
32	UL: -	DL: 1452 - 1496	✗
35		1850 to 1910	✓
38		2570 to 2620	✓
39		1880 to 1920	✓
40		2300 to 2400	✓
41		2496 to 2690	✓
42		3400 to 3600	✗
43		3600 to 3800	✗

*Covered bands represent an efficiency greater than 20%

3. Antenna Characteristics

3.1. Return Loss

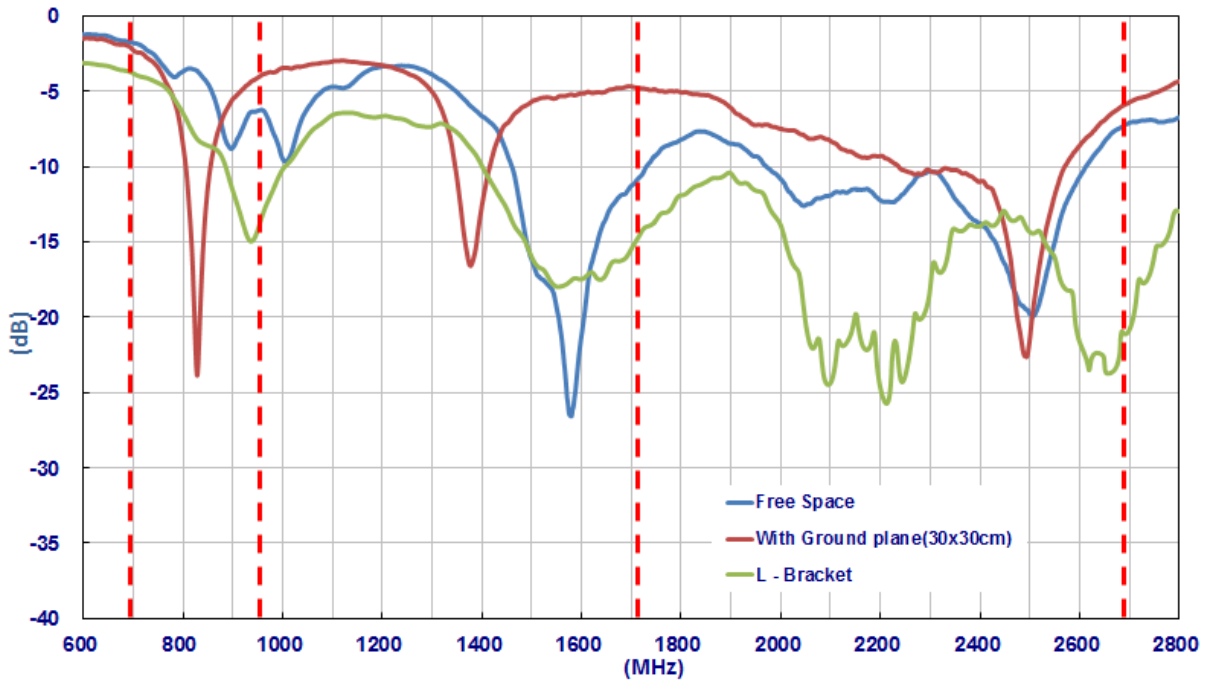

3.2. Antenna Efficiency

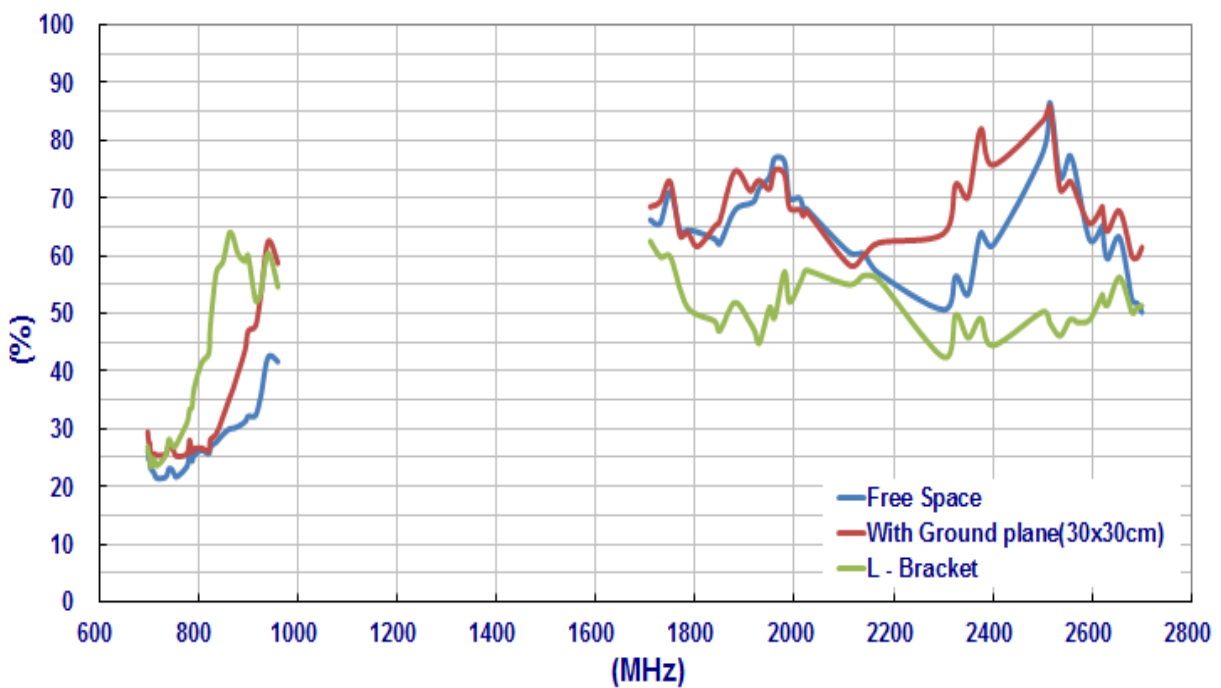

3.3. Peak Gain

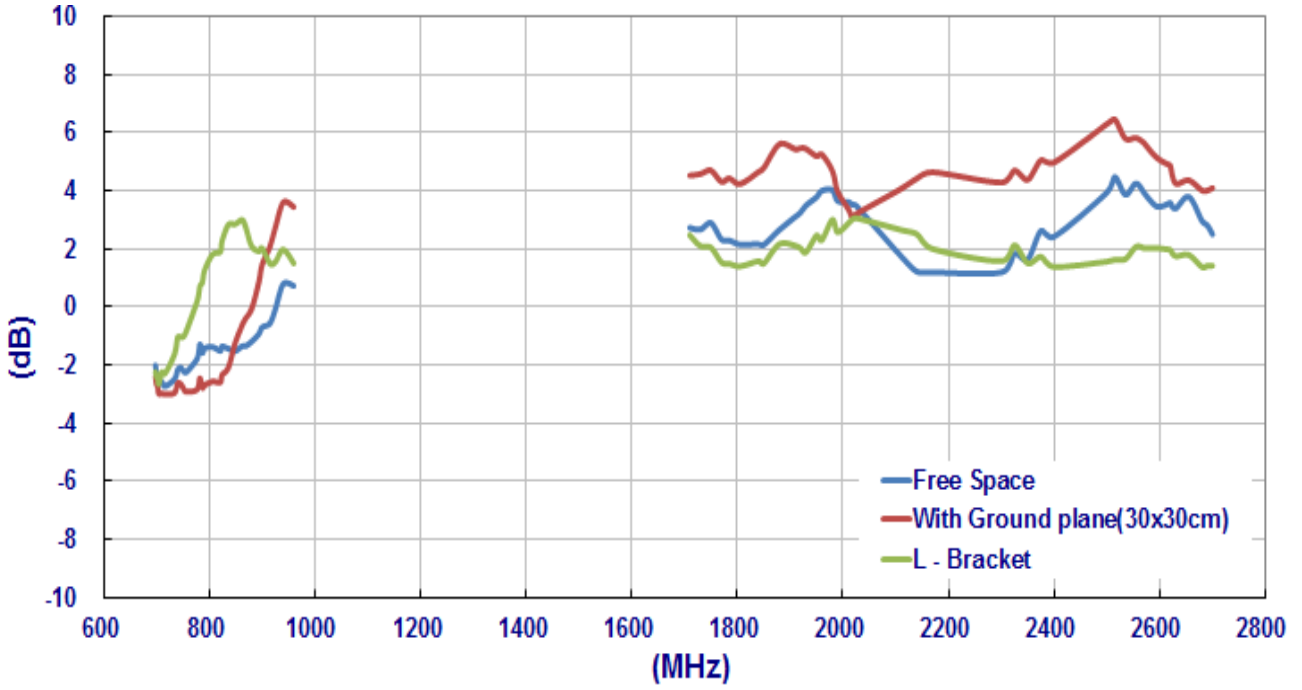

4. Antenna Radiation Pattern

4.1. Antenna Stand Alone

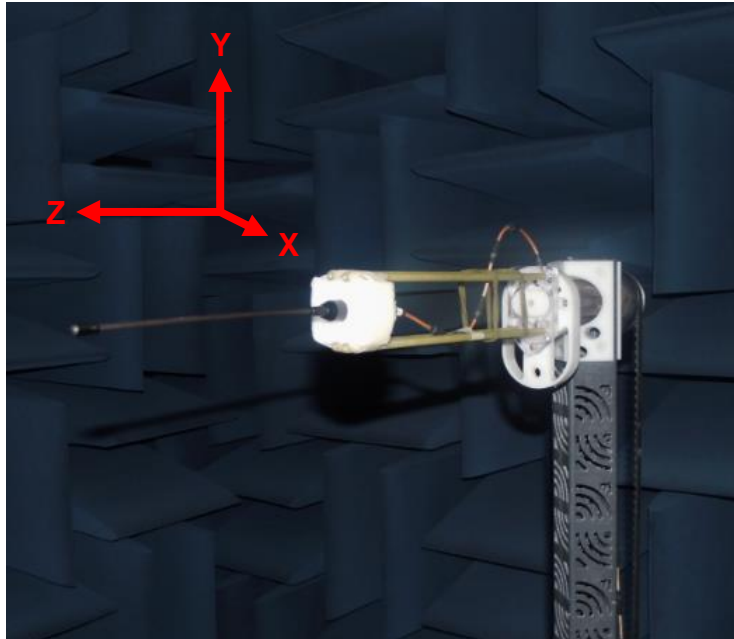



XY Plane

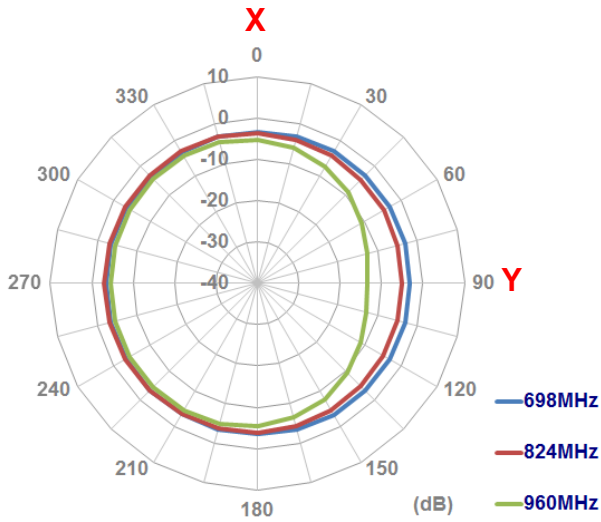

XZ Plane

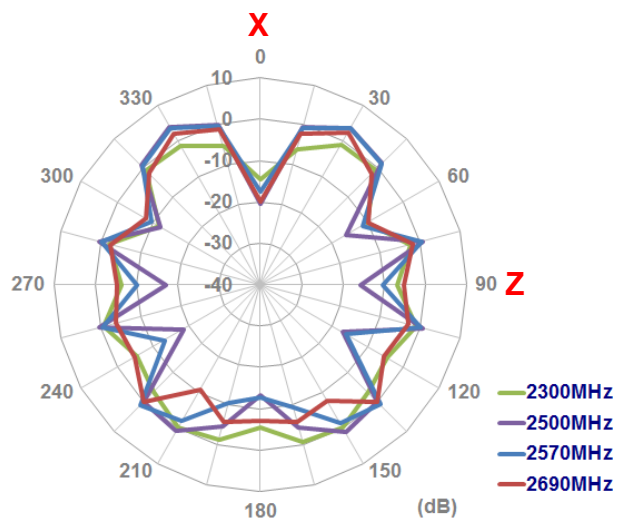
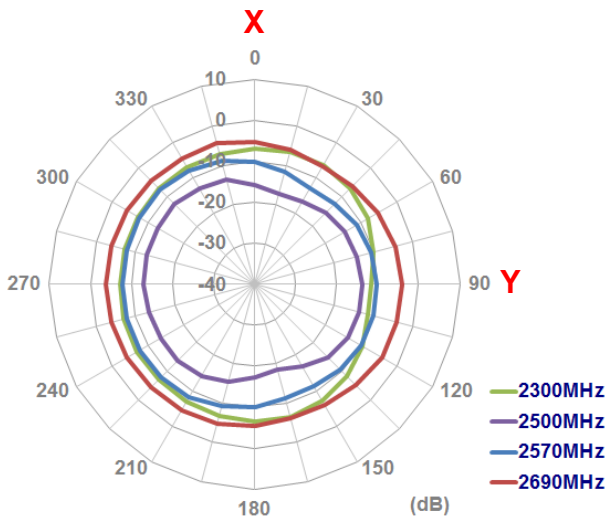
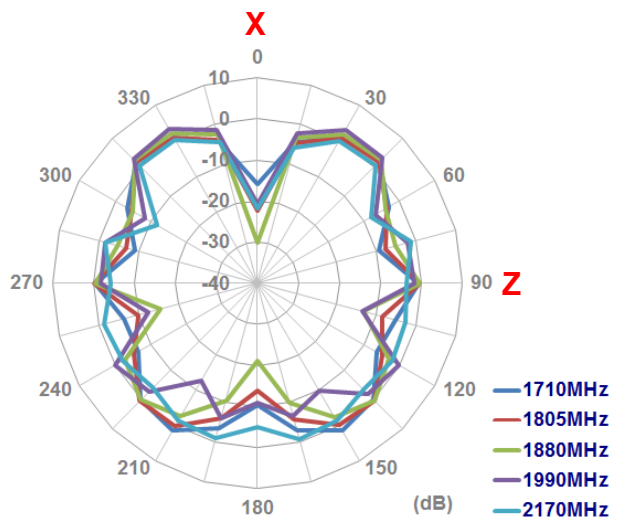
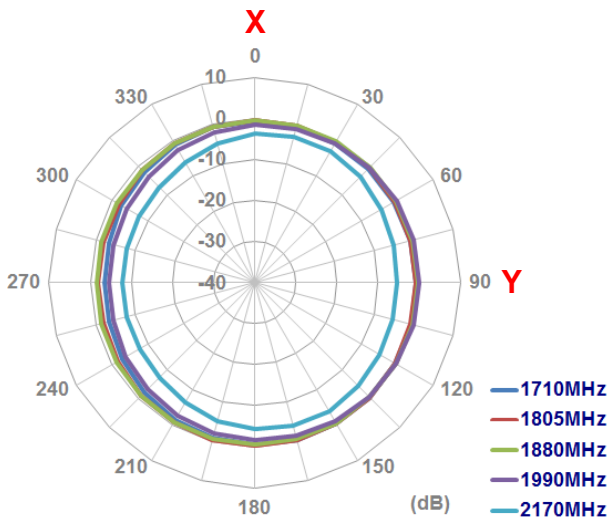
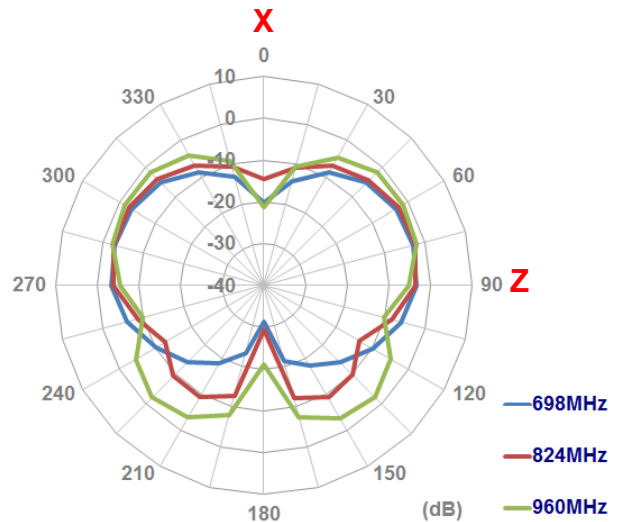

4.2. Antenna with Ground plane (30X30cm)

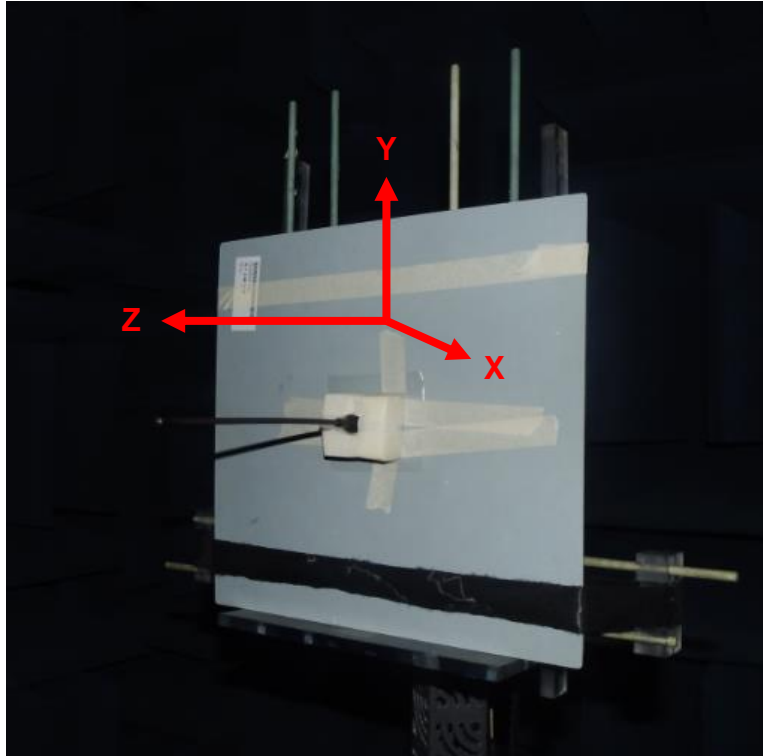



XY Plane

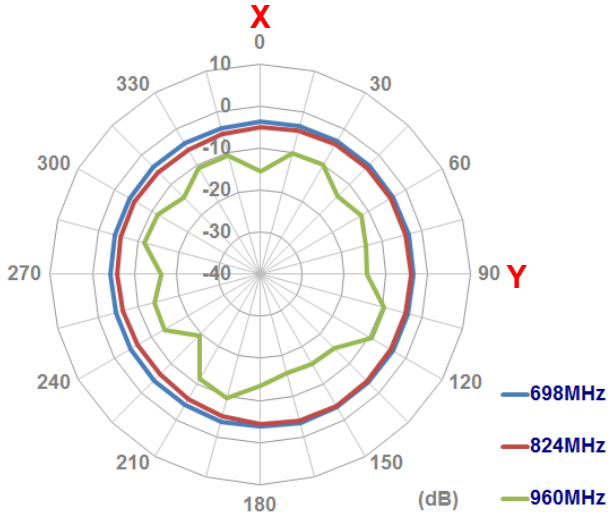

XZ Plane

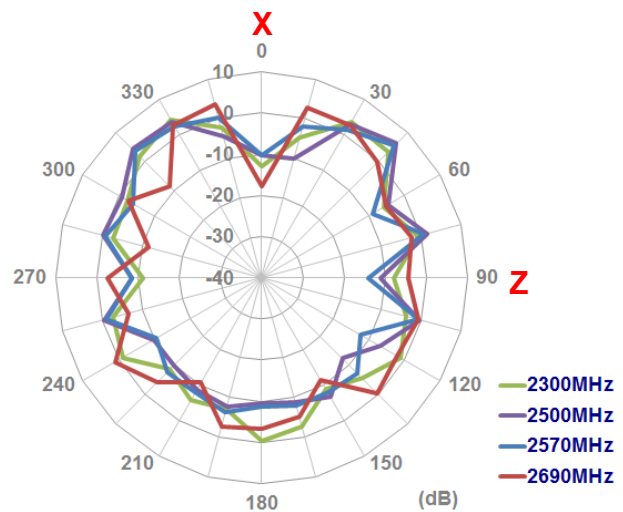
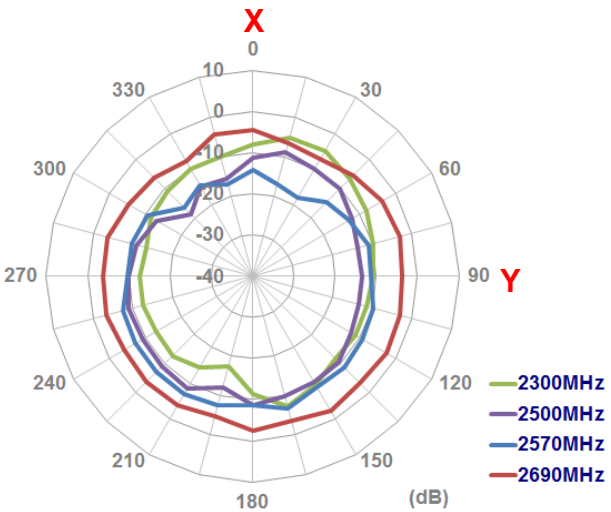
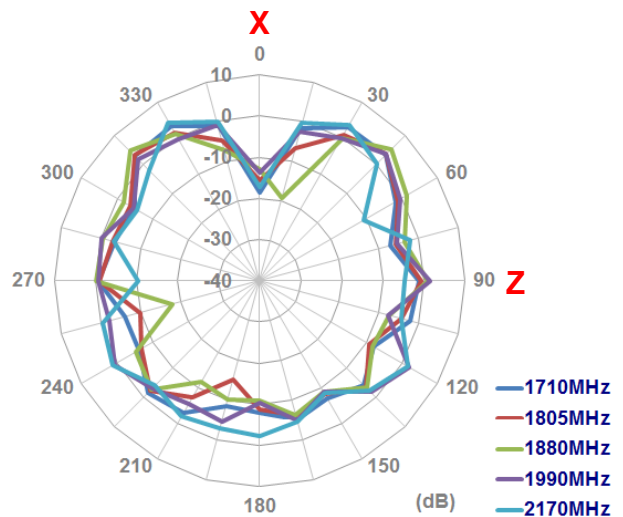
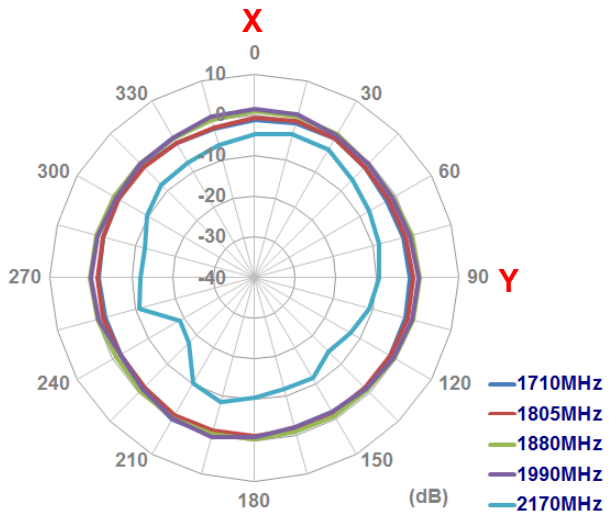
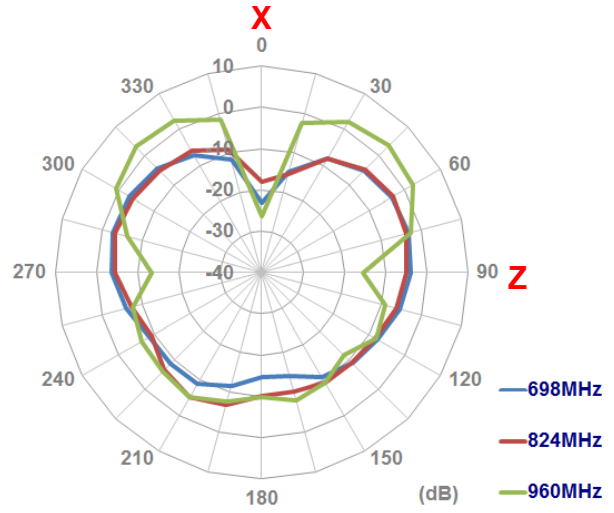

4.3. Antenna with L-Bracket

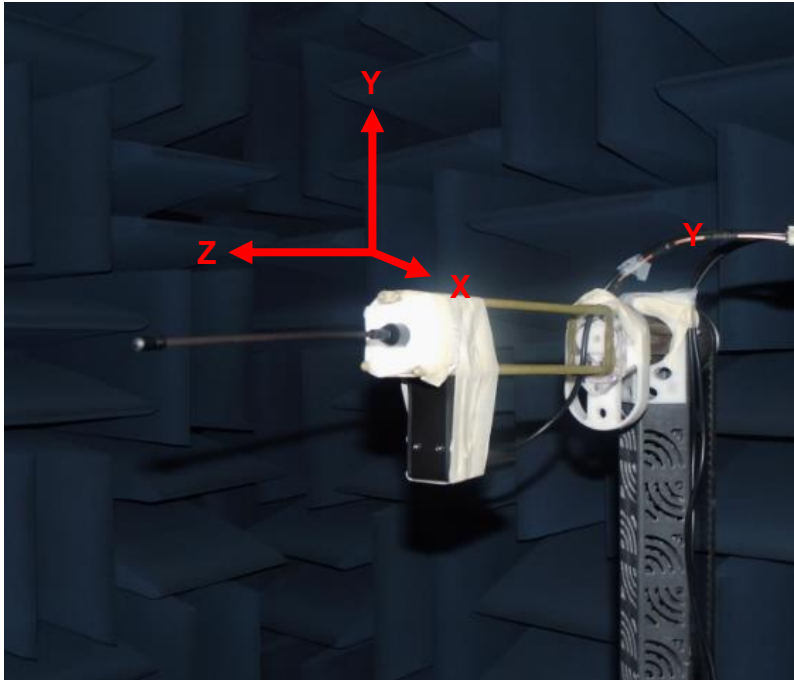



XY Plane

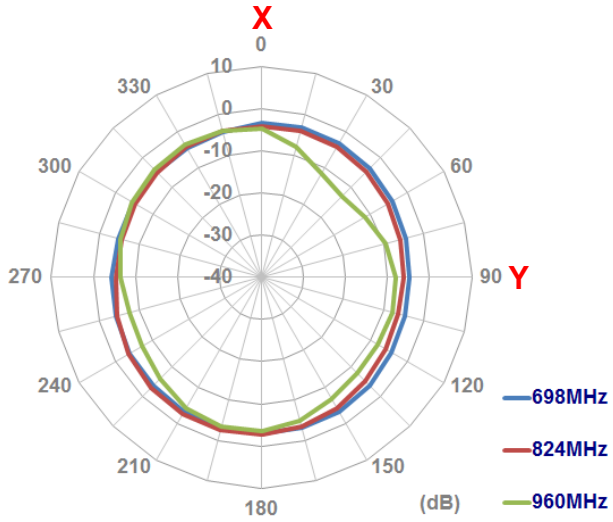

XZ Plane

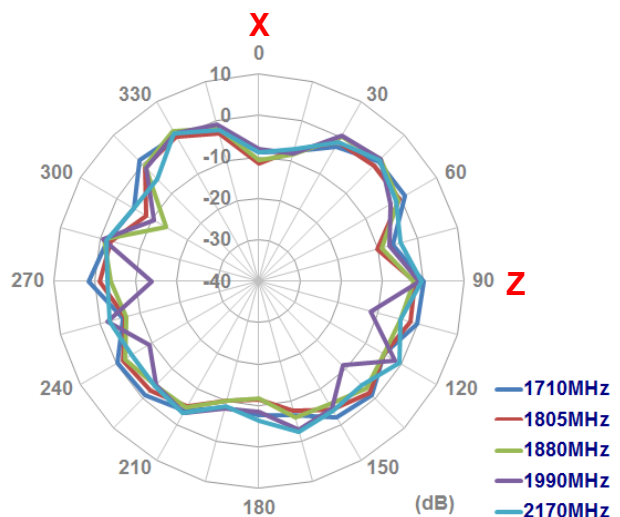
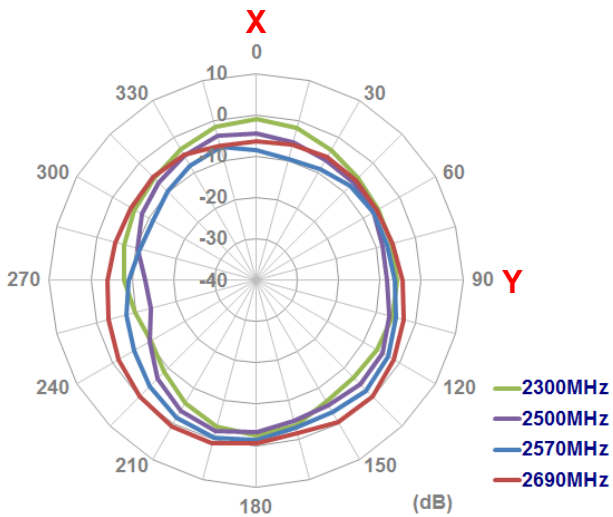
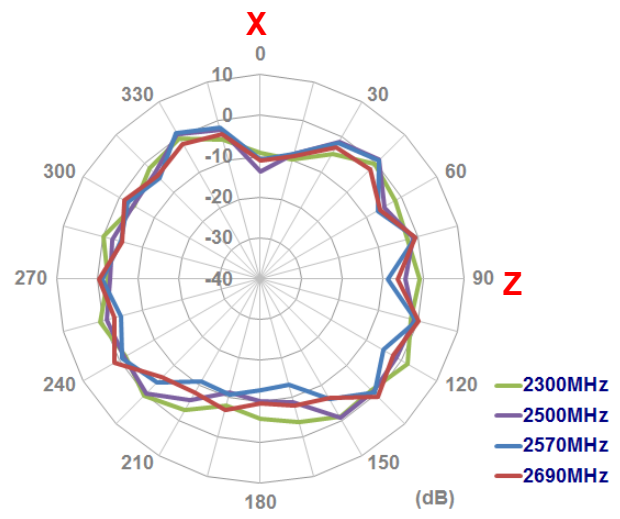
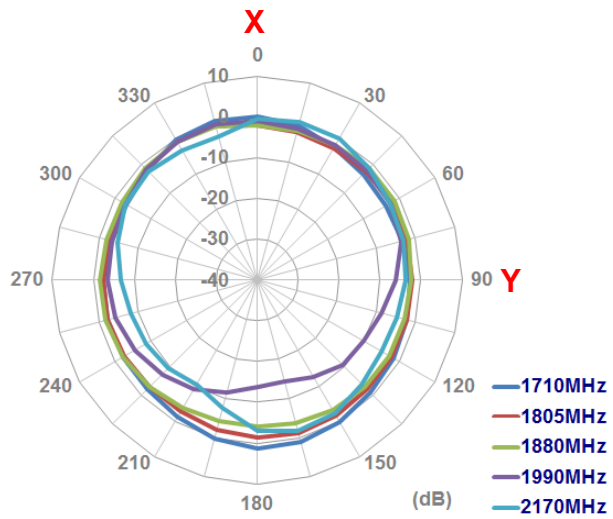
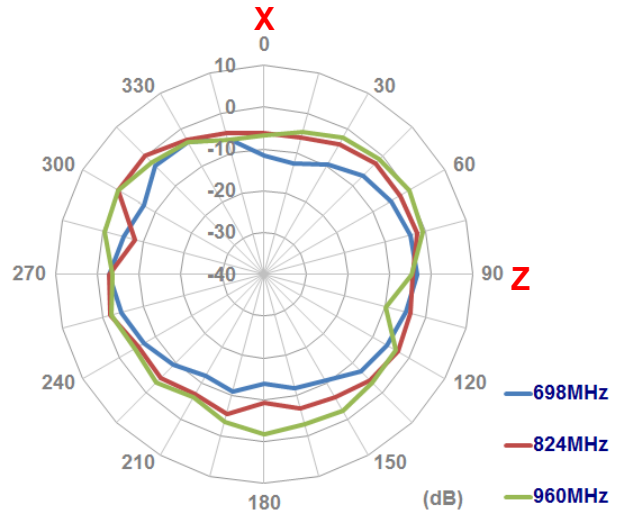



5. Antenna Drawing

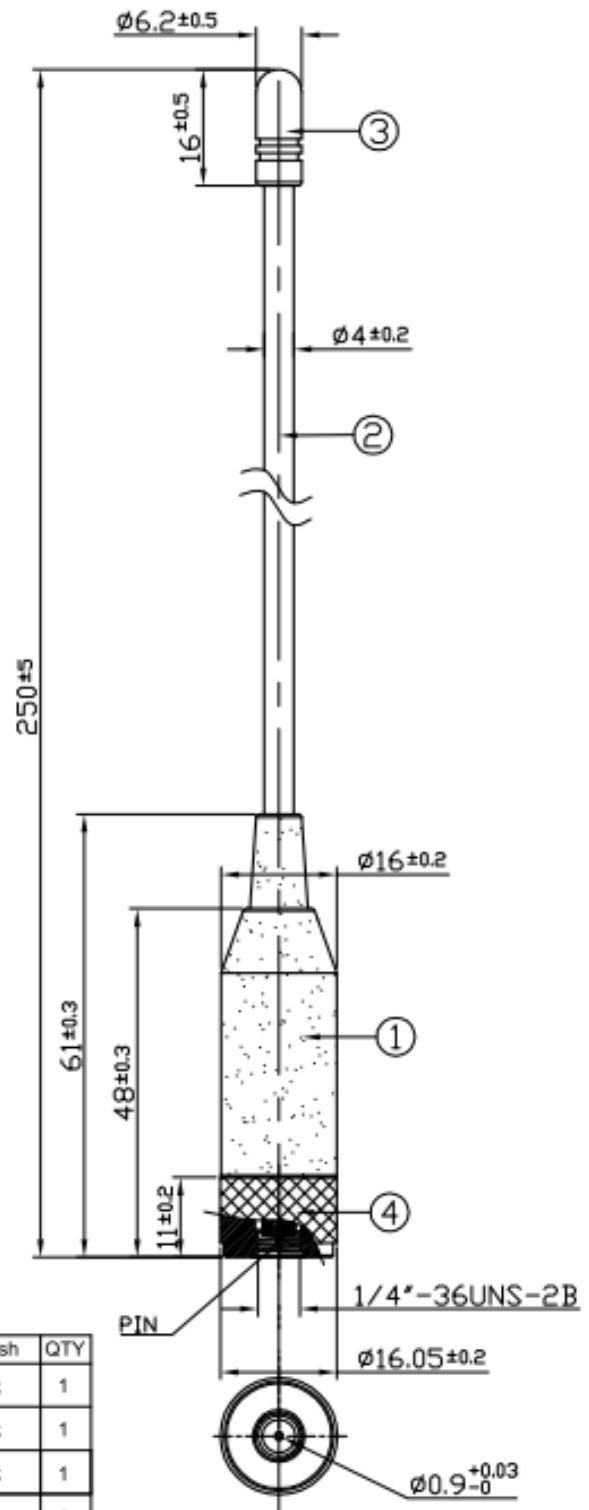

	Name	Material	Finish	QTY
①	Housing	ABS	Black	1
②	Flexible Whip	Steel+PE Jacket	Black	1
③	Cap	ABS	Black	1
④	Outer Body SMA(M)	Brass	Black	1

6. Packaging

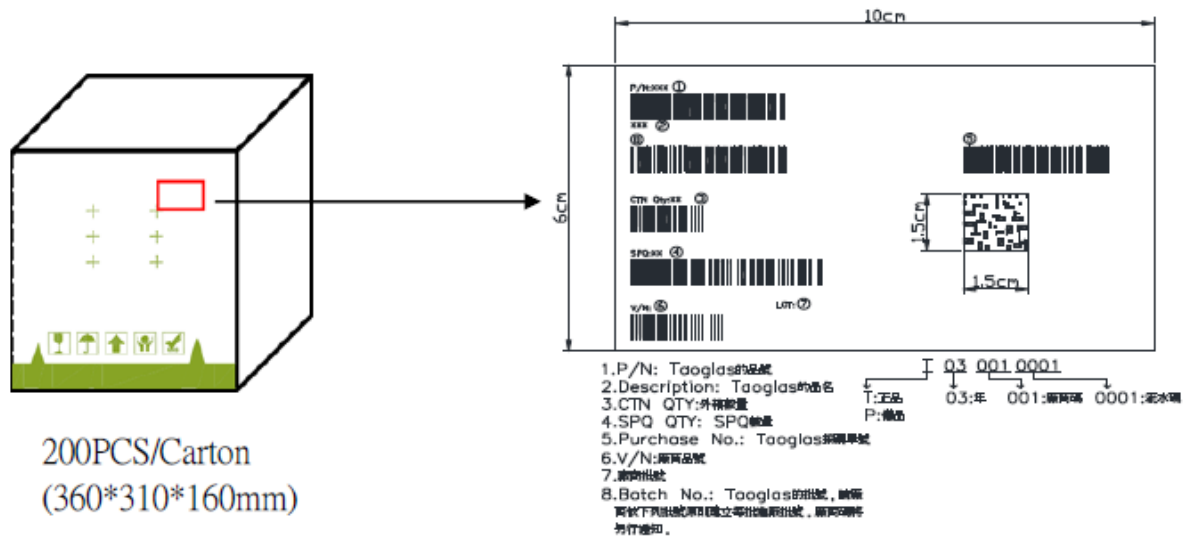
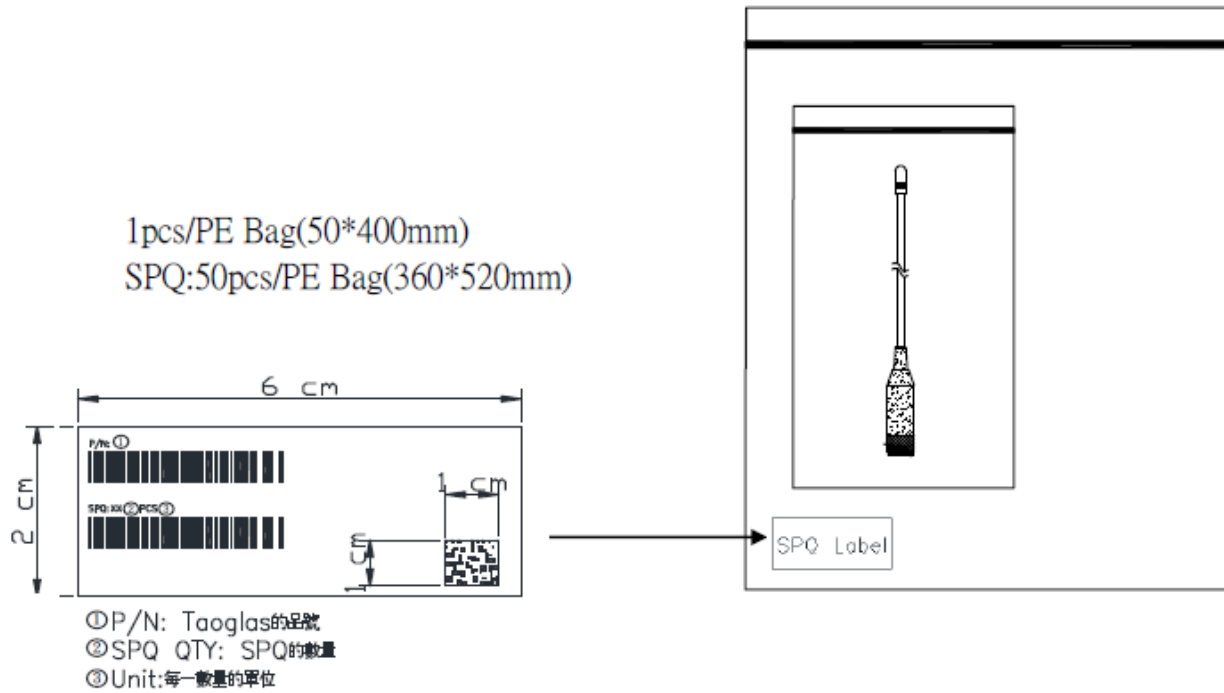



Taoglas makes no warranties based on the accuracy or completeness of the contents of this document and reserves the right to make changes to specifications and product descriptions at any time without notice. Taoglas reserves all rights to this document and the information contained herein.

Reproduction, use or disclosure to third parties without express permission is strictly prohibited.

Copyright © Taoglas Ltd.