

Alle Rechte vorbehalten/ All rights reserved

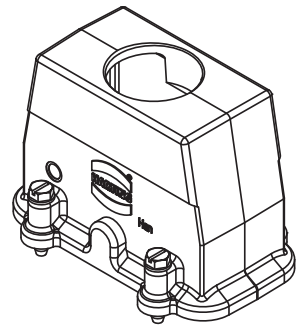

X (2:1)

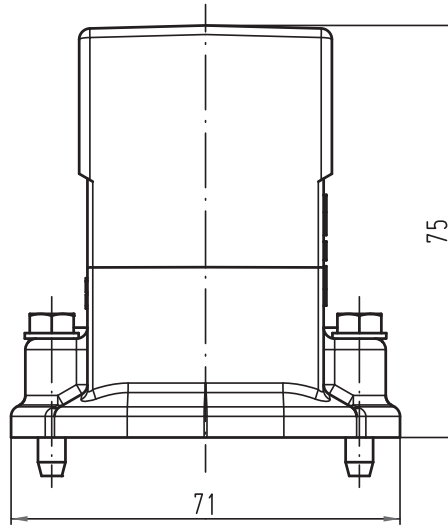
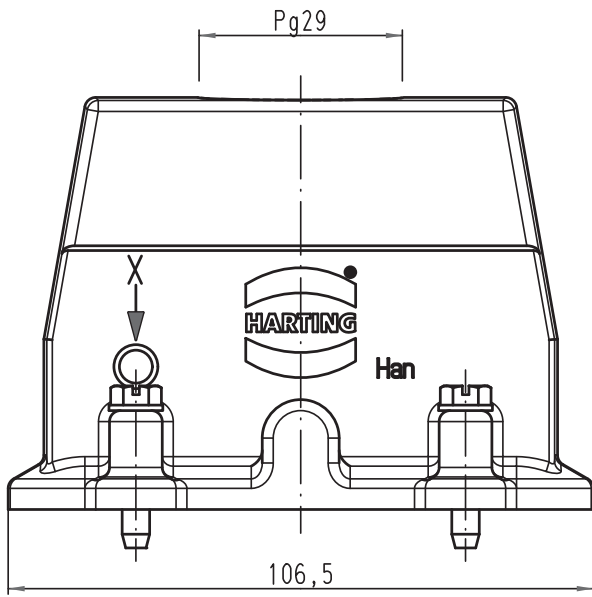
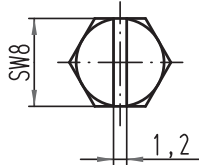

All Dimensions in mm Original Size DIN A 4		Techn. Character.			Nicht tolerierte Maß/Free size tolerances	
			Dat.	Name	Maßstab/Scale 1:1	Han 16HP-gg-29 Tüllengehäuse hood
			Detail.	24.01.11 gru		
			Insp.	Tie		
			Stand.			
A			HARTING Electric GmbH & Co. KG			TB 09 39 016 0407 Sub. TB 09 39 016 0407 v. 18.09.03
Mod.	Dat.	Name	D-32339 Espelkamp			
						Blatt/page