

TCK-046

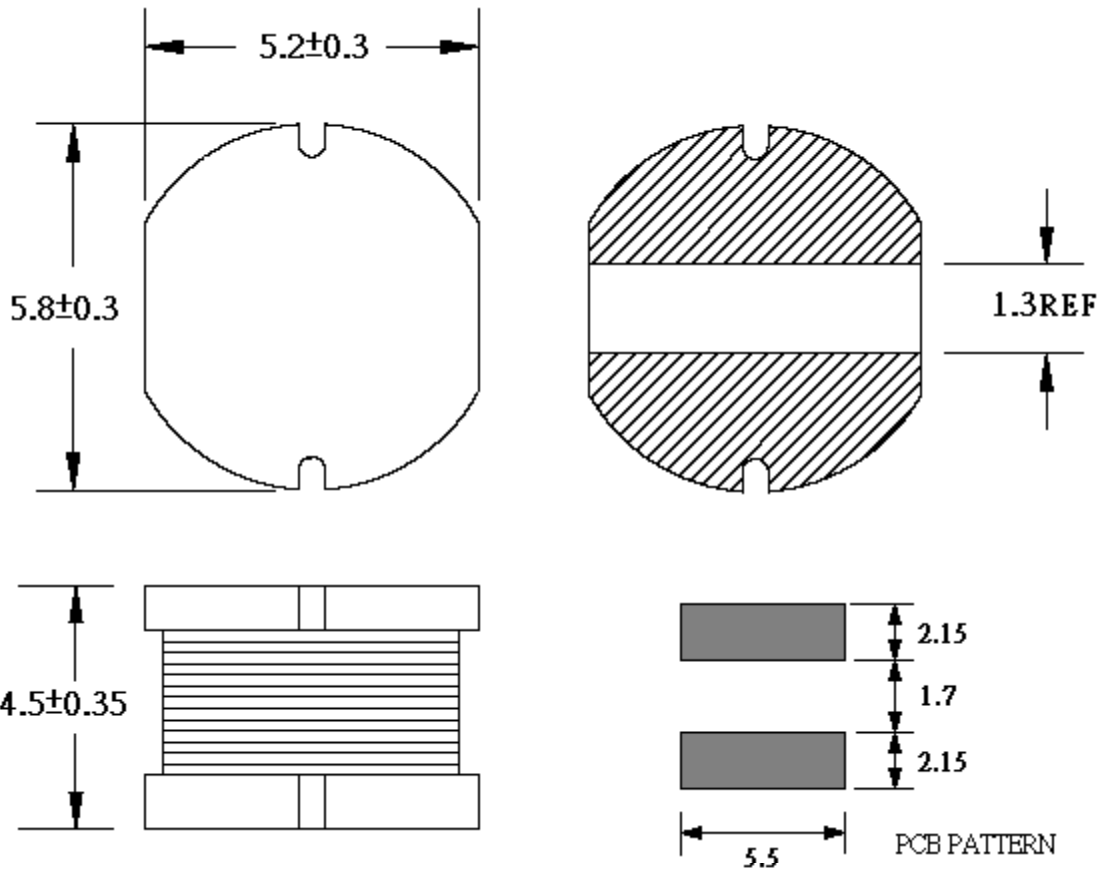

All dimensions in mm

SPECIFICATIONS

Inductance	$18\mu\text{H} \pm 20\%$
	Test Condition: 1KHz/1000mV Measurement Instrument: HP 4263B LCR Meter
Impedance	DCR(Max): $150\text{m}\Omega$
	Measurement Instrument: Agilent 34401A Meter
Rated current	IDC(Max): 1.2A
	Measurement Instrument: Agilent 34401A Meter