

Description

- Surface mount temperature compensated voltage controlled crystal oscillator.
- Freq Adj option
Option A (standard):
Ageing adjustment by means of external Control Voltage applied to pad 1
Range (frequency \leq 20MHz) \geq ± 5 ppm
Range (frequency $>$ 20MHz) \geq ± 7 ppm
Linearity $\leq 2\%$
Slope Positive
Input resistance $\geq 100k\Omega$
Modulation bandwidth $\geq 2kHz$
Standard control voltage range $1.5V \pm 1V$
- Model CFPT-9301-A
- Model Issue number 7

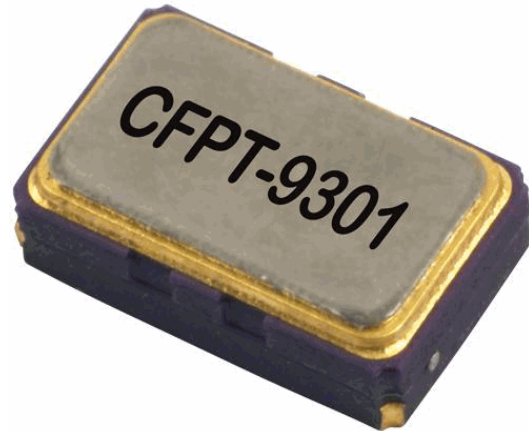

Frequency Parameters

- Frequency 20.0MHz
- Frequency Tolerance ± 1.00 ppm
- Frequency Stability ± 1.00 ppm
- Operating Temperature Range -40.00 to $85.00^\circ C$
- Ageing ± 1 ppm max in 1st year (see Note 1)
- Supply Voltage Variation (@ $\pm 5\%$ change):
Frequency < 20 MHz: ± 0.1 ppm typ
Frequency 20MHz to < 35 MHz: ± 0.3 ppm typ
Frequency 35MHz to 52MHz: ± 0.5 ppm typ
- Load Variation (@ $\pm 5pF$ change):
Frequency < 20 MHz: ± 0.2 ppm typ
Frequency 20MHz to < 35 MHz: ± 0.3 ppm typ
Frequency 35MHz to 52MHz: ± 0.5 ppm typ
- Note 1 Ageing:
Frequency ≤ 20 MHz: ± 1 ppm max in 1st year
Frequency ≤ 20 MHz: ± 3 ppm max for 10 years (including the 1st year)
Frequency > 20 MHz: ± 2 ppm max in 1st year
Frequency > 20 MHz: ± 5 ppm max for 10 years (including the 1st year)

Electrical Parameters

- Supply Voltage $3.3V \pm 10\%$
- Supply Current (typical):
HCMOS:
 $1 + \text{Frequency(MHz)} * \text{Supply(V)} * \{\text{Load(pF)} + 15\} * 10^{-3} \text{mA}$
e.g. 20MHz, 3.3V, 15pF $\approx 3\text{mA}$
- Supply Voltage Tolerance: Parts will operate correctly with $\pm 10\%$ supply voltage variation but supply coefficient is measured with $\pm 5\%$ variation
- Frequency Adjustment - option B
No frequency adjustment
Initial calibration: $\leq \pm 1.0$ ppm

Outline (mm)

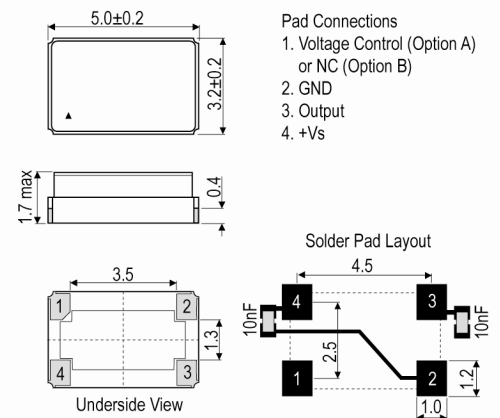

Test Circuit

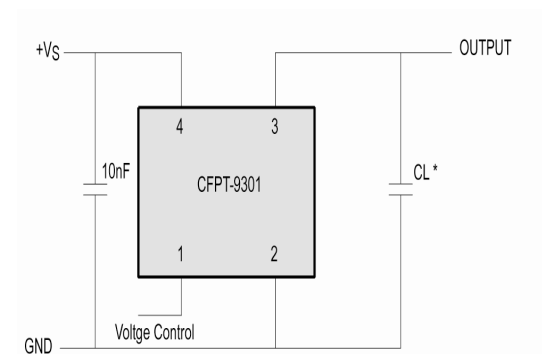

* Load 15pF (HCMOS), inclusive of probe and jig capacitance

Sales Office Contact Details:

UK: +44 (0)1460 270200
Germany: 0800 1808 443

France: 0800 901 383
USA: +1.760.318.2824

Email: info@iqdfrequencyproducts.com
Web: www.iqdfrequencyproducts.com

Frequency Adjustment

- Pulling Optional
- Frequency Adjustment - option A (standard):
Ageing adjustment by means of external Control Voltage applied to pad 1
Range (frequency \leq 20MHz): $\geq \pm 5$ ppm
Range (frequency $>$ 20MHz): $\geq \pm 7$ ppm
Linearity: $\leq 2\%$
Slope: Positive
Input resistance: $\geq 100k\Omega$
Modulation bandwidth: ≥ 2 kHz
Standard control voltage range: 1.5V \pm 1V

Output Details

- Output Compatibility HCMOS
- Drive Capability 15pF max
- Rise and Fall Time 8.0ns max
- Duty Cycle 45/55%

Output Levels

- Output Level:
VoH $\geq 90\%$ VS
VoL $\leq 10\%$ VS

Environmental Parameters

- Storage Temperature Range: -55 to 125°C
- Shock: IEC 60068-2-27, Test Ea: 1500G acceleration for 0.5ms, 3 shocks in each of 3 mutually perpendicular planes
- Vibration: IEC 60068-2-6, Test Fc: 10-60Hz 1.5mm displacement, 60-2000Hz at 20G, 4 hours in each of three mutually perpendicular axes at 1oct/min

Compliance

- RoHS Status (2011/65/EU) Compliant
- REACh Status Compliant
- MSL Rating (JEDEC-STD-033): Not Applicable

Packaging Details

- Pack Style: Bulk Loose in bulk pack
- Pack Size: 10
- *Alternative packing option available*

Test Circuit

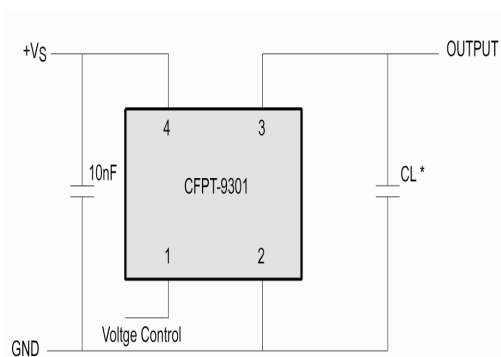

* Load 15pF (HCMOS), inclusive of probe and jig capacitance

Typical Phase Noise at 14.4MHz

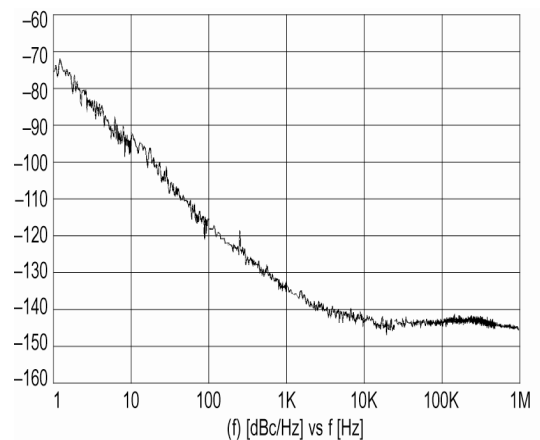

Sales Office Contact Details:

UK: +44 (0)1460 270200
Germany: 0800 1808 443

France: 0800 901 383
USA: +1.760.318.2824

Email: info@iqdfrequencyproducts.com
Web: www.iqdfrequencyproducts.com

Chipset Approval Table

Ref No.		Frequency	Chipset Type	IC Supplier	
E4190LF		12.8MHz	ACS1790T, ACS9510, ACS9520T, ACS9522T, ACS9550, ACS9593T, ACS8522BT, ACS8509, ACS8510, ACS8514, ACS8515, ACS8520, ACS8520A, ACS8522	Semtech	
E4191LF		12.8MHz	ACS1790T, ACS9510, ACS9520T, ACS9522T, ACS9550, ACS9593T, ACS8522BT, ACS8509, ACS8510, ACS8514, ACS8515, ACS8520, ACS8520A, ACS8522	Semtech	
E4437LF		12.8MHz	ACS1790T, ACS9510, ACS9520T, ACS9522T, ACS9550, ACS9593T, ACS8522BT, ACS8509, ACS8510, ACS8514, ACS8515, ACS8520, ACS8520A, ACS8522	Semtech	
E4438LF		20MHz	ZL30152, ZL30155, ZL30157, ZL30159, ZL30160, ZL30165	Microsemi	
E4439LF		20MHz	ZL30152, ZL30155, ZL30157, ZL30159, ZL30160, ZL30165	Microsemi	
E4441LF		20MHz	ZL30152, ZL30155, ZL30157, ZL30159, ZL30160, ZL30165	Microsemi	
E4698LF		12.8MHz	ACS1790T, ACS9510, ACS9520T, ACS9522T, ACS9550, ACS9593T, ACS8522BT, ACS8509, ACS8510, ACS8514, ACS8515, ACS8520, ACS8520A, ACS8522	Semtech	

Sales Office Contact Details:

UK: +44 (0)1460 270200
Germany: 0800 1808 443

France: 0800 901 383
USA: +1.760.318.2824

Email: info@iqdfrequencyproducts.com
Web: www.iqdfrequencyproducts.com