

TL3210 SERIES TACT SWITCH

ANTI-VANDAL SWITCHES
 DETECTOR SWITCHES
 DIP SWITCHES
 KEYLOCK SWITCHES
 NAVIGATION SWITCHES
 PUSHBUTTON SWITCHES
 ROCKER SWITCHES
 ROTARY SWITCHES
 SLIDE SWITCHES
 SNAP ACTION SWITCHES
TACTILE SWITCHES
 TOGGLE SWITCHES
 CAP OPTIONS

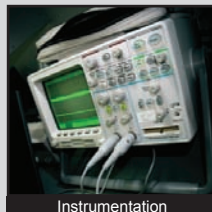

APPLICATIONS / MARKETS

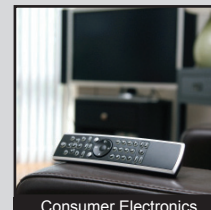
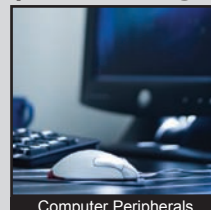
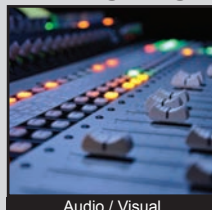

RoHS

SPECIFICATIONS

Electrical Rating: 50mA @ 12VDC
Life Expectancy: 100,000 Cycles
Contact Resistance: 500mΩ Max.
Insulation Resistance: 100 MΩ Min. at 100VDC
Dielectric Strength: 250VAC for 1 min.
Operating Temperature: -20°C to 70°C
Storage Temperature: -30°C to 80°C
Operating Force: 160 gf +/- 50 gf
Travel: 0.2mm +/- 0.1mm
Contact Arrangement: SPST, Normally Open

FEATURES & BENEFITS

- Illumination options
- Tape & Reel packaging: 2000 pieces per reel
- Miniature size: 5.6mm x 3.5mm
- Surface Mount Design

PART NUMBER CONFIGURATOR

Series	Model	Actuator	Force	LED	Contact Material
TL	3210	A	F160	B - Blue G - Green R - Red Y - Yellow W - White X - Red/Green Bi-color Z - Green/Yellow Bi-color	Q - Silver

Specifications subject to change without notice



E-SWITCH®

www.e-switch.com

800.867.2717

2

TL3210 SERIES TACT SWITCH

BODY DIMENSIONS

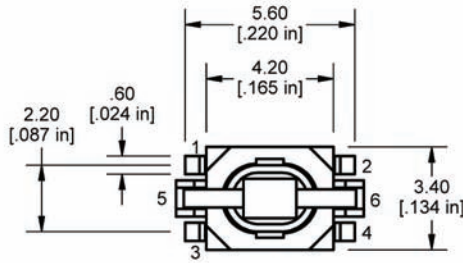

This surface taped for automated pickup: Remove tape after soldering

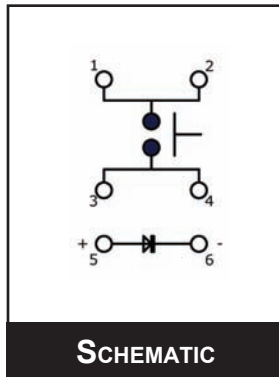
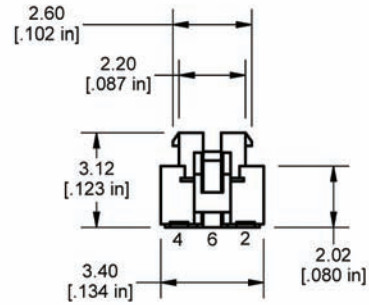
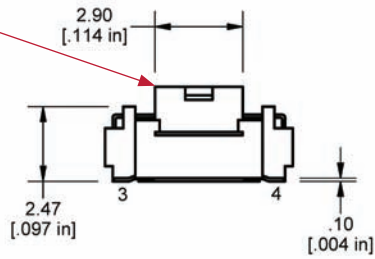

SCHEMATIC

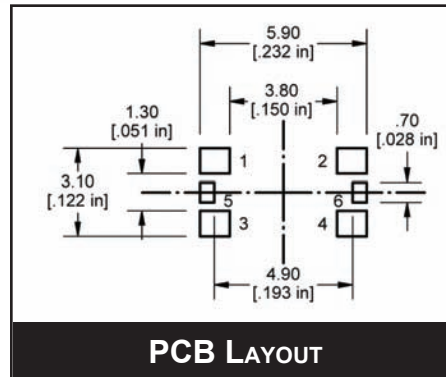

PCB LAYOUT

LED Specifications			
	Forward Current (mA)	Forward Voltage V @ 20mA	Luminous Intensity (mcd)
Blue	20mA	3.8 min - 3.3 typ. VDC	80 mcd
Red	20mA	1.95 typ. - 2.5 max VDC	230 mcd
Green	20mA	2.1 typ. - 2.5 max VDC	50 mcd
Yellow	20mA	2.0 typ. - 2.5 max VDC	160 mcd
White	20mA	3.3 typ. - 4.0 max. VDC	300 mcd
Red/Green Bi-color	Red: 20mA Green: 20mA	Red: 1.95 typ - 2.5 max VDC Green: 3.3 typ. - 4.1 max. VDC	Red: 220 mcd Green: 200 mcd
Yellow/Green Bi-Color	Yellow: 20mA Green: 20mA	Yellow: 2.0 typ. - 2.5 max VDC Green: 2.1 typ. - 2.5 max VDC	Yellow: 180 mcd Green: 60 mcd



ANTI-VANDAL SWITCHES
DETECTOR SWITCHES
DIP SWITCHES
KEYLOCK SWITCHES
NAVIGATION SWITCHES
PUSHBUTTON SWITCHES
ROCKER SWITCHES
ROTARY SWITCHES
SLIDE SWITCHES
SNAP ACTION SWITCHES
TACTILE SWITCHES
TOGGLE SWITCHES
CAP OPTIONS