

LUMIFA LF1A

Control Panels • Manufacturing Equipment

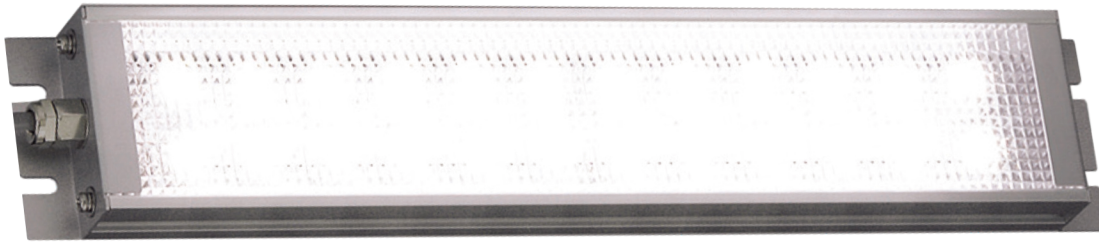

PRODUCT DESCRIPTION

LF1A LED strips use super-bright multi-chip LEDs providing illumination equivalent to a 25W fluorescent lamp, while consuming only one-third the power. They come in a thin housing available in three sizes with four color configurations: cool white (5500K), warm white (2800K), yellow (590nm) and red (625nm).

KEY FEATURES

- Brightness: 66.6 Lumens/Watt
- Energy savings: One-third of fluorescent lamps
- Long life: 40,000 hrs (Half-life)
- UL Listed
- RoHS Compliant
- IP40

GENERAL SPECIFICATIONS

Model		LF1A-*-2THWW6	LF1A-*-2TLWW6	LF1A-*-2SHY8	LF1A-*-2SHR8
Rated Voltage		24V DC (non-polarized)			
Input Current (at rated voltage), mA	LED Array 3 x 2	75		90	
	LED Array 6 x 2	150		180	
	LED Array 12 x 2	300		360	
Rated Power (at rated voltage), W	LED Array 3 x 2	1.8		2.2	
	LED Array 6 x 2	3.6		4.4	
	LED Array 12 x 2	7.2		8.7	
Dielectric Strength		Between live and dead parts: 1000V AC, 1 minute			
Insulation Resistance		Between live and dead parts: 100 MΩ (500V DC megger)			
Operating Temperature		-20 to +50°C			
Storage Temperature		-25 to +70°C			
Operating/Storage Humidity		45 to 85% RH (no condensation)			
Life (half luminance) ¹		40,000 hours			
Degree of Protection		IP40			
Weight (approx.), g		LF1A-A1: 190, LF1A-B1: 270, LF1A-D1: 470			

*LED Array A1 = 3x2, B1 = 6x2, D1 = 12x2

1. LED life depends on the operating environment.





LED OPTICAL SPECIFICATIONS

Model	LF1A-*-2THWW6	LF1A-*-2TLWW6	LF1A-*-2SHY8	LF1A-*-2SHR8
illumination Color	Cool White	Warm White	Yellow	Red
Luminous Intensity (Single LED module), mcd	6000	4000	4000	2500
Color Temperature/Dominant Wavelength	5500K	2800K	590nm	625nm
Reference Illuminance at 0.5m, lx	LED Array 3 x 2	190	130	85
	LED Array 6 x 2	380	260	170
	LED Array 12 x 2	760	520	340

*LED Array A1 = 3x2, B1 = 6x2, D1 = 12x2

PART NUMBERS

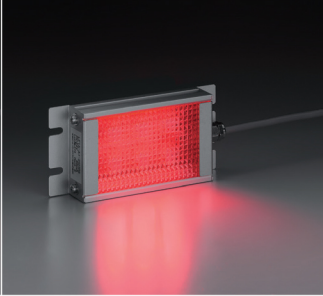
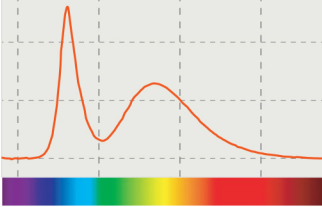
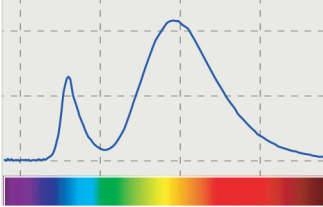
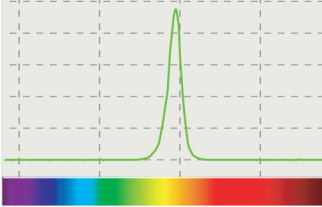
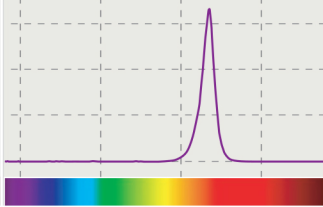
Color	Cool White	Warm White	Yellow	Red
Part Number	LF1A-*-2THWW6	LF1A-*-2TLWW6	LF1A-*-2SHY8	LF1A-*-2SHR8
Appearance				
Light Spectrum				

*LED Array A1 = 3x2, B1 = 6x2, D1 = 12x2

PART NUMBER STRUCTURE (USE FOR INTERPRETING PART NUMBERS ONLY)

LF1A - A1 - 2 THWW6

LED Module Arrangement
A1: 3 LEDs x 2 rows
B1: 6 LEDs x 2 rows
D1: 12 LEDs x 2 rows

LED Illumination Color
THWW6: Cool White
TLWW6: Warm White
SHY8: Yellow
SHR8: Red

DIMENSIONS (mm)

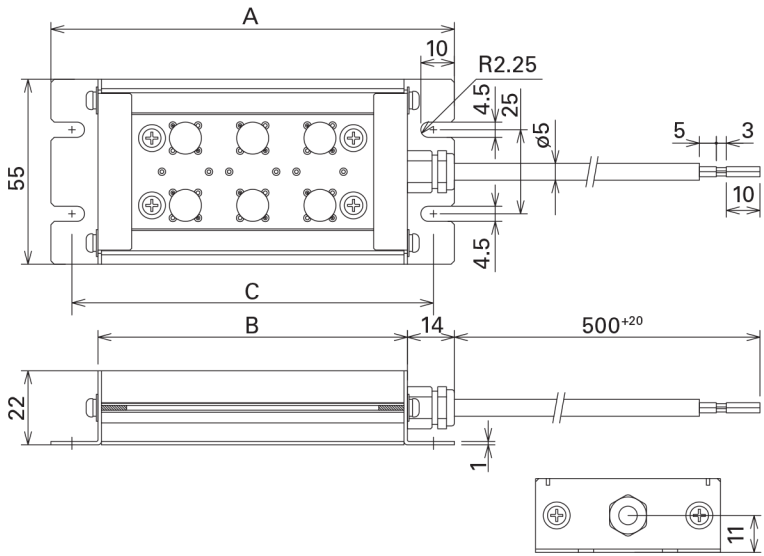

Part Number	A	B	C
LF1A-A1-	120	92	108
LF1A-B1-	180	152	168
LF1A-D1-	300	272	288

ILLUMINANCE CHART (LF1A-D1-2THWW6)

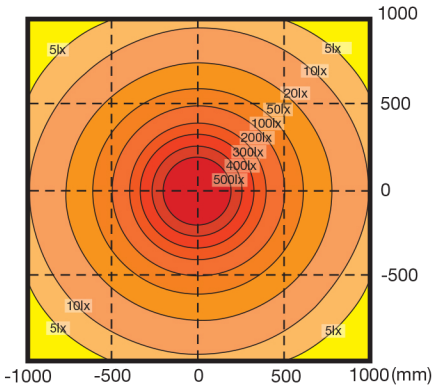

ACCESSORY

Item	Mounting Bracket—Adjustable Angle	
Part No.	LF9Z-1MA1	
Material	Stainless Steel	

1 pair, Left and Right.