

Part Number: AA3528F3S

Features

- Mechanically and spectrally matched to the phototransistor.
- Package : 2000pcs / reel.
- Moisture sensitivity level : level 3.
- RoHS compliant.

Description

F3 Made with Gallium Arsenide Infrared Emitting diodes.

Package Dimensions

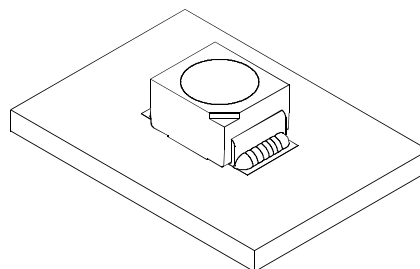
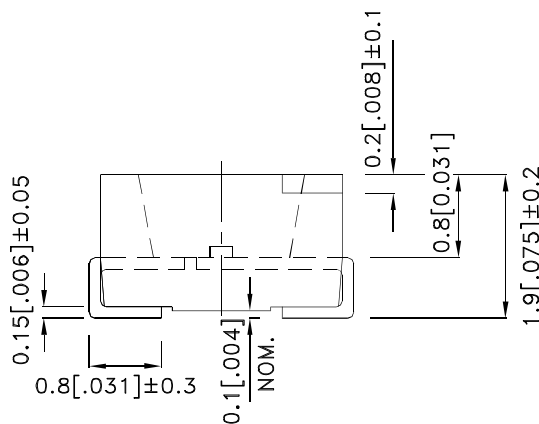
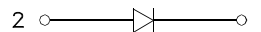
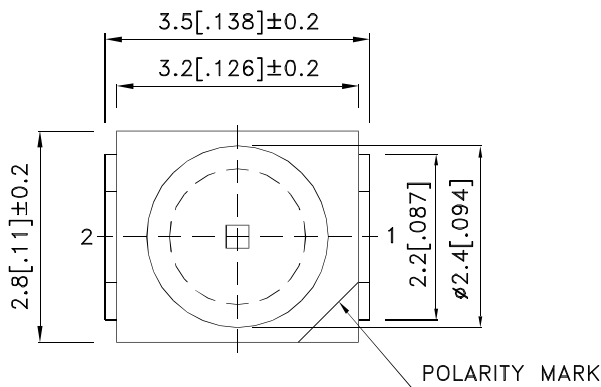

Notes:

1. All dimensions are in millimeters (inches).
2. Tolerance is ± 0.25 (0.01") unless otherwise noted.
3. The specifications, characteristics and technical data described in the datasheet are subject to change without prior notice.
4. The device has a single mounting surface. The device must be mounted according to the specifications.



Handling Precautions

Compare to epoxy encapsulant that is hard and brittle, silicone is softer and flexible. Although its characteristic significantly reduces thermal stress, it is more susceptible to damage by external mechanical force.

As a result, special handling precautions need to be observed during assembly using silicone encapsulated LED products. Failure to comply might lead to damage and premature failure of the LED.

1. Handle the component along the side surfaces by using forceps or appropriate tools.

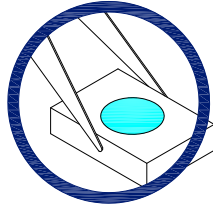

2. Do not directly touch or handle the silicone lens surface. It may damage the internal circuitry.

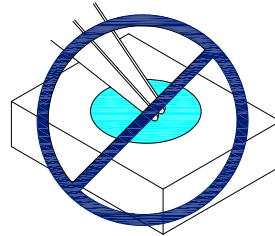
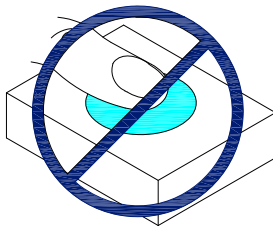

3. Do not stack together assembled PCBs containing exposed LEDs. Impact may scratch the silicone lens or damage the internal circuitry.

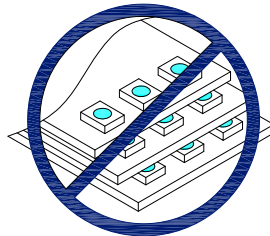

- 4.1. The inner diameter of the SMD pickup nozzle should not exceed the size of the LED to prevent air leaks.
- 4.2. A pliable material is suggested for the nozzle tip to avoid scratching or damaging the LED surface during pickup.
- 4.3. The dimensions of the component must be accurately programmed in the pick-and-place machine to insure precise pickup and avoid damage during production.

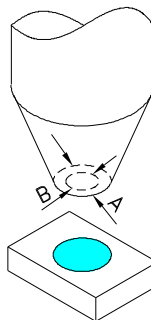

5. As silicone encapsulation is permeable to gases, some corrosive substances such as H_2S might corrode silver plating of leadframe. Special care should be taken if an LED with silicone encapsulation is to be used near such substances.

All design applications should refer to Kingbright application notes available at <http://www.KingbrightUSA.com/ApplicationNotes>

Selection Guide

Part No.	Dice	Lens Type	Po (mW/sr) [2] @ 20mA		Viewing Angle [1]
			Min.	Typ.	2θ1/2
AA3528F3S	F3 (GaAs)	Water Clear	1.6	4	120°
			*1.2	*2.5	

Notes:

1. θ1/2 is the angle from optical centerline where the luminous intensity is 1/2 of the optical peak value.
 2. Radiant Intensity/ luminous flux: +/-15%.
- *Radiant Intensity value is traceable to the CIE127-2007 compliant national standards.

Electrical / Optical Characteristics at TA=25°C

Parameter	P/N	Symbol	Typ.	Max.	Units	Test Conditions
Forward Voltage [1]	F3	V _F	1.2	1.6	V	I _F =20mA
Reverse Current	F3	I _R		10	μA	V _R = 5V
Capacitance	F3	C	90		pF	V _F =0V;f=1MHz
Peak Spectral Wavelength	F3	λ _P	940		nm	I _F =20mA
Spectral Bandwidth	F3	Δλ1/2	50		nm	I _F =20mA

Note:

1. Forward Voltage: +/-0.1V.
2. Wavelength value is traceable to the CIE127-2007 compliant national standards.

Absolute Maximum Ratings at TA=25°C

Parameter	Symbol	F3	Units
Power dissipation	P _D	80	mW
DC Forward Current	I _F	50	mA
Peak Forward Current [1]	i _{FS}	1.2	A
Reverse Voltage	V _R	5	V
Operating Temperature	T _A	-40 To +85	°C
Storage Temperature	T _{STG}	-40 To +85	°C

Note:

1. 1/100 Duty Cycle, 10μs Pulse Width.

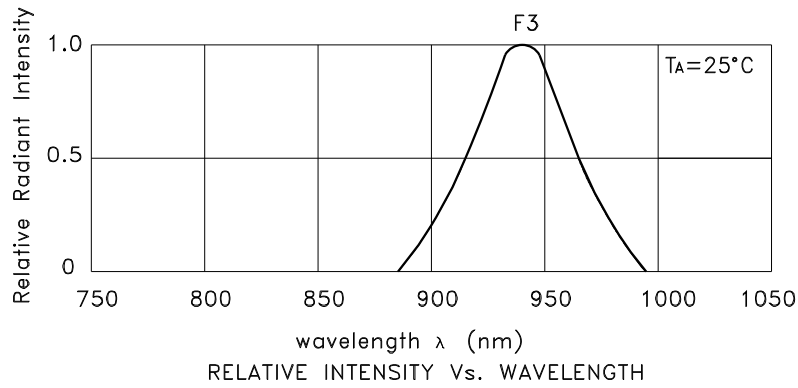

AA3528F3S

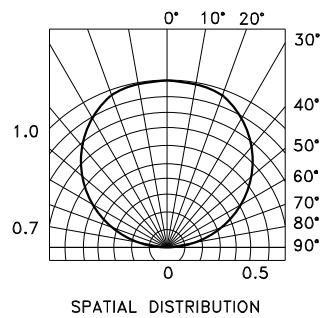
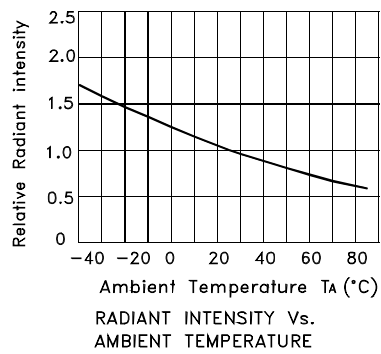
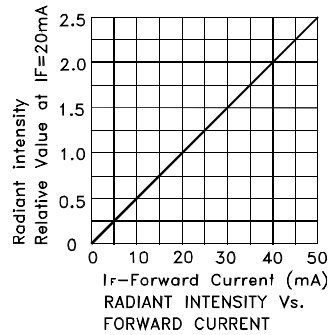
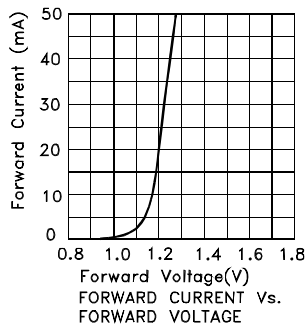

AA3528F3S

Reflow soldering is recommended and the soldering profile is shown below.
Other soldering methods are not recommended as they might cause damage to the product.

Reflow Soldering Profile For Lead-free SMT Process.

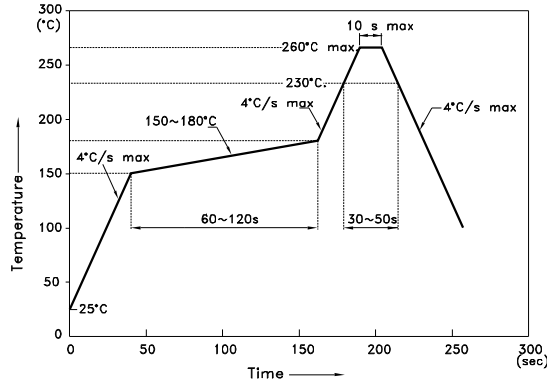

NOTES:

1. We recommend the reflow temperature 245°C(+/-5°C). The maximum soldering temperature should be limited to 260°C.
2. Don't cause stress to the epoxy resin while it is exposed to high temperature.
3. Number of reflow process shall be 2 times or less.

Recommended Soldering Pattern (Units : mm; Tolerance: ± 0.1)

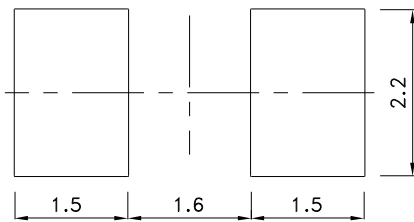

Reel Dimension

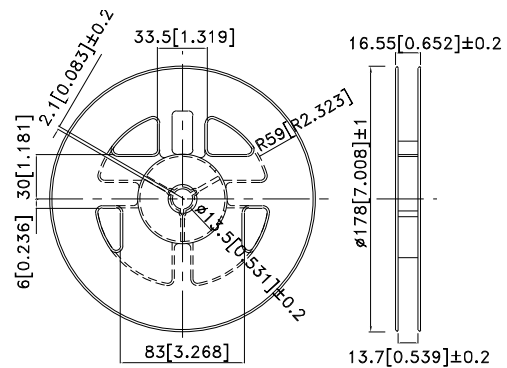

Tape Specifications (Units : mm)

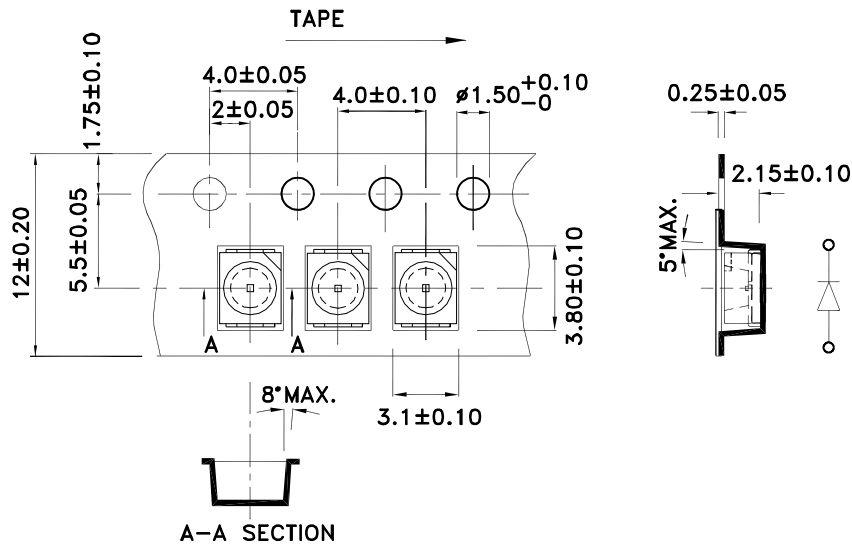

Kingbright

PACKING & LABEL SPECIFICATIONS

AA3528F3S

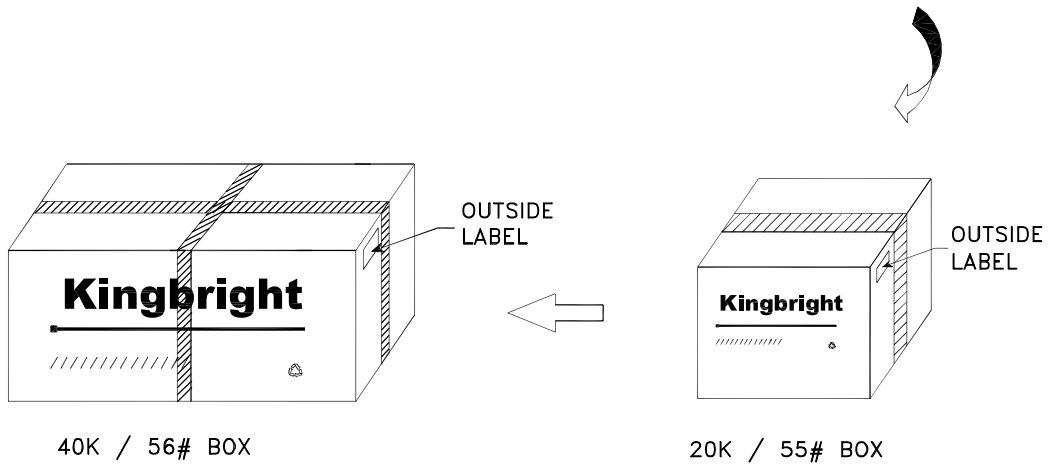
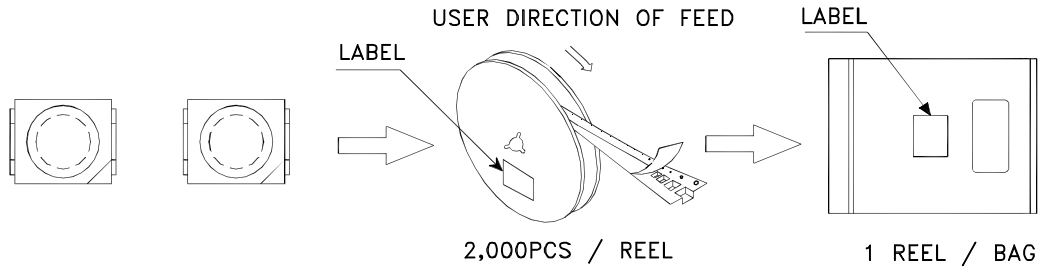

<h2>Kingbright</h2>	
P/NO: AA3528xxx	
QTY: 2,000 pcs	Q.C. Q C XX XX XXXX PASSED
S/N: XXXX	
CODE: XXX	
LOT NO:	
 <small>XXXXXXXXXXXXXXXXXXXXXXXXXX</small>	
RoHS Compliant	