



ON Semiconductor®

## FDD5N50FTM-WS

### N-Channel UniFET™ FRFET® MOSFET 500 V, 3.5 A, 1.55 Ω

#### Features

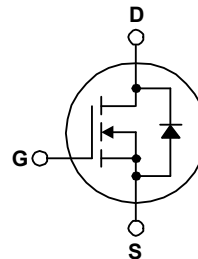
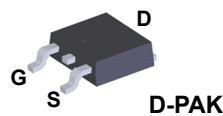
- $R_{DS(on)} = 1.25\Omega$  (Typ.) @  $V_{GS} = 10\text{ V}$ ,  $I_D = 1.75\text{ A}$
- Low Gate Charge (Typ. 11 nC)
- Low  $C_{rss}$  (Typ. 5 pF)
- Fast Switching
- 100% Avalanche Tested
- Improved dv/dt Capability
- RoHS Compliant

#### Applications

- LCD/LED/PDP TV
- Lighting
- Uninterruptible Power Supply
- AC-DC Power Supply

#### Description

UniFET™ MOSFET is ON Semiconductor's high voltage MOSFET family based on planar stripe and DMOS technology. This MOSFET is tailored to reduce on-state resistance, and to provide better switching performance and higher avalanche energy strength. The body diode's reverse recovery performance of UniFET FRFET® MOSFET has been enhanced by lifetime control. Its trr is less than 100nsec and the reverse dv/dt immunity is 15V/ns while normal planar MOSFETs have over 200nsec and 4.5V/nsec respectively. Therefore, it can remove additional component and improve system reliability in certain applications in which the performance of MOSFET's body diode is significant. This device family is suitable for switching power converter applications such as power factor correction (PFC), flat panel display (FPD) TV power, ATX and electronic lamp ballasts.



#### MOSFET Maximum Ratings $T_C = 25^\circ\text{C}$ unless otherwise noted.

Symbol	Parameter	Ratings	Units
$V_{DSS}$	Drain to Source Voltage	500	V
$V_{GSS}$	Gate to Source Voltage	±30	V
$I_D$	Drain Current	- Continuous ( $T_C = 25^\circ\text{C}$ )	3.5
		- Continuous ( $T_C = 100^\circ\text{C}$ )	2.1
$I_{DM}$	Drain Current	- Pulsed (Note 1)	14
$E_{AS}$	Single Pulsed Avalanche Energy	(Note 2)	257
$I_{AR}$	Avalanche Current	(Note 1)	3.5
$E_{AR}$	Repetitive Avalanche Energy	(Note 1)	4
dv/dt	Peak Diode Recovery dv/dt	(Note 3)	4.5
$P_D$	Power Dissipation	( $T_C = 25^\circ\text{C}$ )	40
		- Derate Above $25^\circ\text{C}$	0.3
$T_J, T_{STG}$	Operating and Storage Temperature Range	-55 to +150	$^\circ\text{C}$
$T_L$	Maximum Lead Temperature for Soldering, 1/8" from Case for 5 Seconds	300	$^\circ\text{C}$

#### Thermal Characteristics

Symbol	Parameter	Ratings	Units
$R_{\theta JC}$	Thermal Resistance, Junction to Case, Max.	1.4	$^\circ\text{C}/\text{W}$
$R_{\theta JA}$	Thermal Resistance, Junction to Ambient, Max.	110	

## Package Marking and Ordering Information

Part Number	Top Mark	Package	Packing Method	Reel Size	Tape Width	Quantity
FDD5N50FTM-WS	FDD5N50F	D-PAK	Tape and Reel	330 mm	16 mm	2500 units

## Electrical Characteristics $T_C = 25^\circ\text{C}$ unless otherwise noted.

Symbol	Parameter	Test Conditions	Min.	Typ.	Max.	Units
--------	-----------	-----------------	------	------	------	-------

### Off Characteristics

$BV_{DSS}$	Drain to Source Breakdown Voltage	$I_D = 250 \mu\text{A}, V_{GS} = 0 \text{ V}, T_J = 25^\circ\text{C}$	500	-	-	V
$\frac{\Delta BV_{DSS}}{\Delta T_J}$	Breakdown Voltage Temperature Coefficient	$I_D = 250 \mu\text{A}$ , Referenced to $25^\circ\text{C}$	-	0.6	-	$\text{V}/^\circ\text{C}$
$I_{DSS}$	Zero Gate Voltage Drain Current	$V_{DS} = 500 \text{ V}, V_{GS} = 0 \text{ V}$ $V_{DS} = 400 \text{ V}, T_C = 125^\circ\text{C}$	-	-	10 100	$\mu\text{A}$
$I_{GSS}$	Gate to Body Leakage Current	$V_{GS} = \pm 30 \text{ V}, V_{DS} = 0 \text{ V}$	-	-	$\pm 100$	nA

### On Characteristics

$V_{GS(th)}$	Gate Threshold Voltage	$V_{GS} = V_{DS}, I_D = 250 \mu\text{A}$	3.0	-	5.0	V
$R_{DS(on)}$	Static Drain to Source On Resistance	$V_{GS} = 10 \text{ V}, I_D = 1.75 \text{ A}$	-	1.25	1.55	$\Omega$
$g_{FS}$	Forward Transconductance	$V_{DS} = 20 \text{ V}, I_D = 1.75 \text{ A}$	-	4.3	-	S

### Dynamic Characteristics

$C_{iss}$	Input Capacitance	$V_{DS} = 25 \text{ V}, V_{GS} = 0 \text{ V}$ $f = 1 \text{ MHz}$	-	490	650	pF
$C_{oss}$	Output Capacitance		-	66	88	pF
$C_{rss}$	Reverse Transfer Capacitance		-	5	7.5	pF
$Q_{g(tot)}$	Total Gate Charge at 10V	$V_{DS} = 400 \text{ V}, I_D = 5 \text{ A},$ $V_{GS} = 10 \text{ V}$	-	11	15	nC
$Q_{gs}$	Gate to Source Gate Charge		-	3	-	nC
$Q_{gd}$	Gate to Drain "Miller" Charge		(Note 4)	-	5	-

### Switching Characteristics

$t_{d(on)}$	Turn-On Delay Time	$V_{DD} = 250 \text{ V}, I_D = 5 \text{ A}$ $R_G = 25 \Omega$	-	13	36	ns
$t_r$	Turn-On Rise Time		-	22	54	ns
$t_{d(off)}$	Turn-Off Delay Time		-	28	66	ns
$t_f$	Turn-Off Fall Time		(Note 4)	-	20	50

### Drain-Source Diode Characteristics

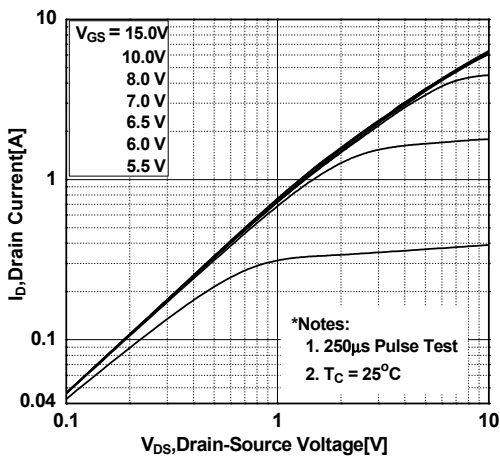
$I_S$	Maximum Continuous Drain to Source Diode Forward Current	-	-	3.5	A	
$I_{SM}$	Maximum Pulsed Drain to Source Diode Forward Current	-	-	14	A	
$V_{SD}$	Drain to Source Diode Forward Voltage	$V_{GS} = 0 \text{ V}, I_{SD} = 3.5 \text{ A}$	-	-	1.5	V
$t_{rr}$	Reverse Recovery Time	$V_{GS} = 0 \text{ V}, I_{SD} = 5 \text{ A}$	-	65	-	ns
$Q_{rr}$	Reverse Recovery Charge	$di_F/dt = 100 \text{ A}/\mu\text{s}$	-	0.120	-	$\mu\text{C}$

#### Notes:

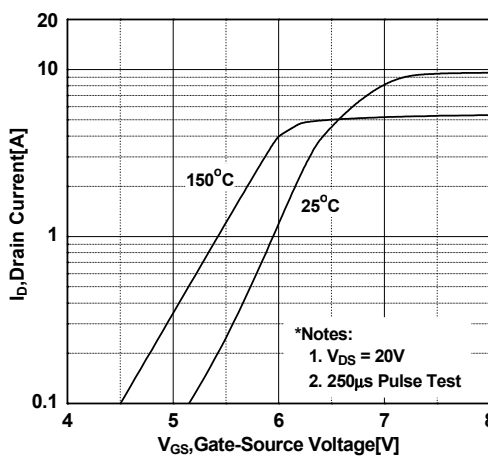
- 1: Repetitive rating; pulse-width limited by maximum junction temperature.
- 2:  $L = 42 \text{ mH}, I_{AS} = 3.5 \text{ A}, V_{DD} = 50 \text{ V}, R_G = 25 \Omega$ , starting  $T_J = 25^\circ\text{C}$ .
- 3:  $I_{SD} \leq 3.5 \text{ A}, di/dt \leq 200 \text{ A}/\mu\text{s}, V_{DD} \leq BV_{DSS}$ , starting  $T_J = 25^\circ\text{C}$ .
- 4: Essentially independent of operating temperature typical characteristics.

## Typical Performance Characteristics

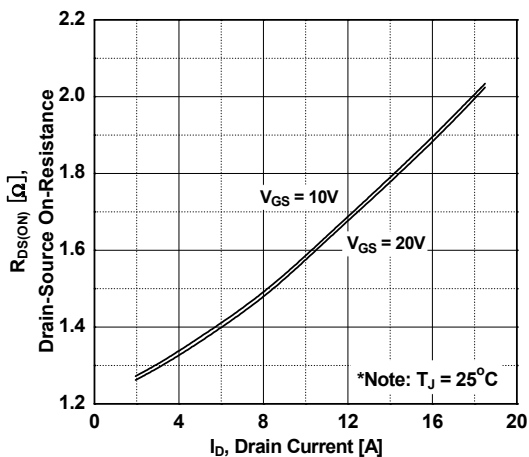
**Figure 1. On-Region Characteristics**



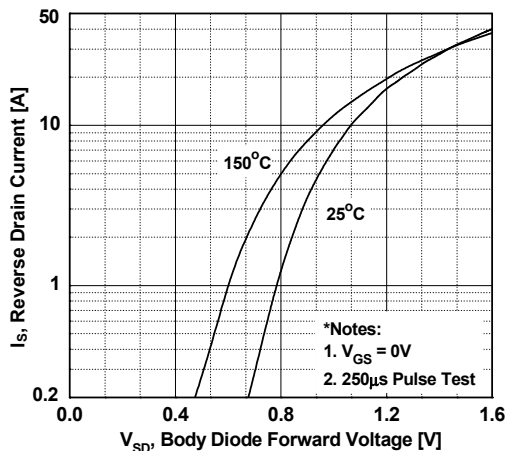
**Figure 2. Transfer Characteristics**



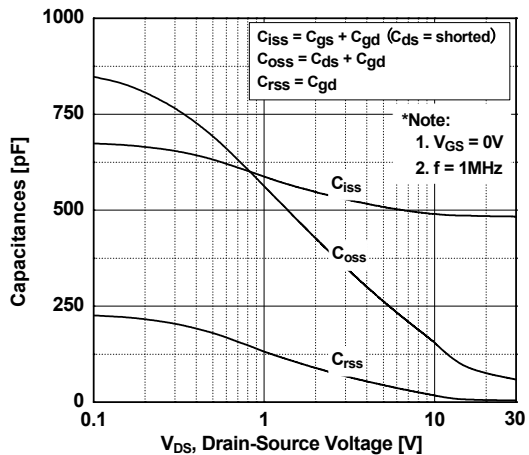
**Figure 3. On-Resistance Variation vs. Drain Current and Gate Voltage**



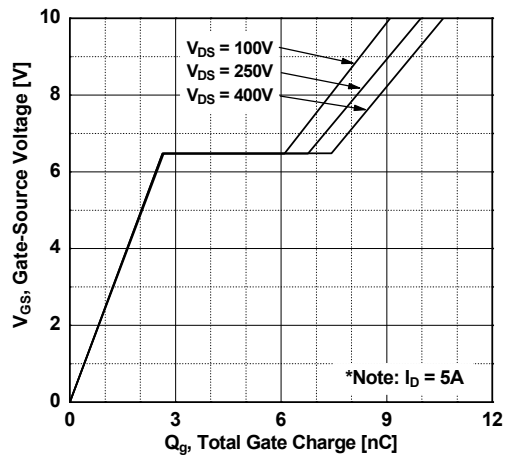
**Figure 4. Body Diode Forward Voltage Variation vs. Source Current and Temperature**



**Figure 5. Capacitance Characteristics**

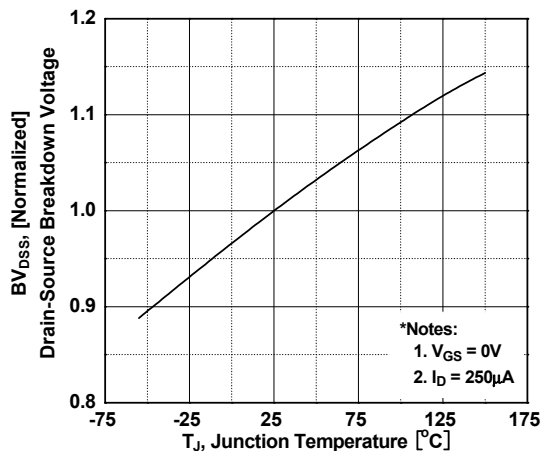


**Figure 6. Gate Charge Characteristics**

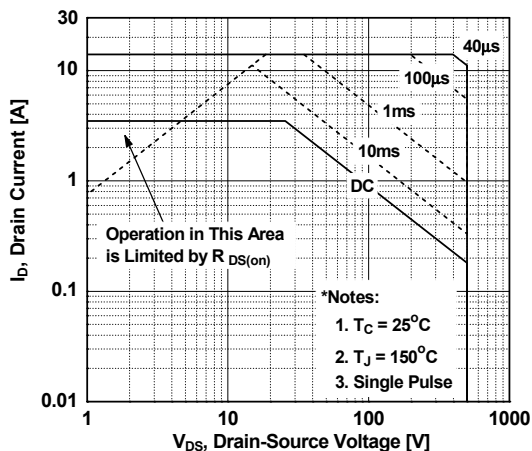


**Typical Performance Characteristics** (Continued)

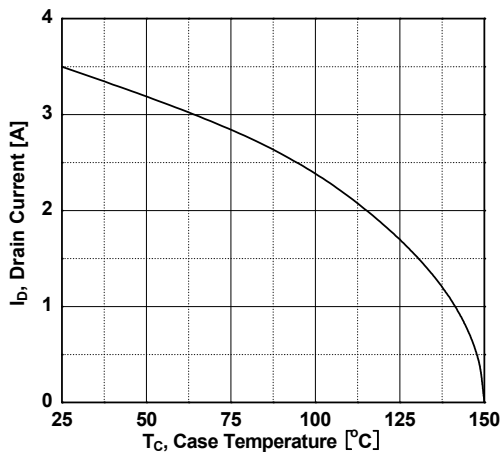
**Figure 7. Breakdown Voltage Variation vs. Temperature**



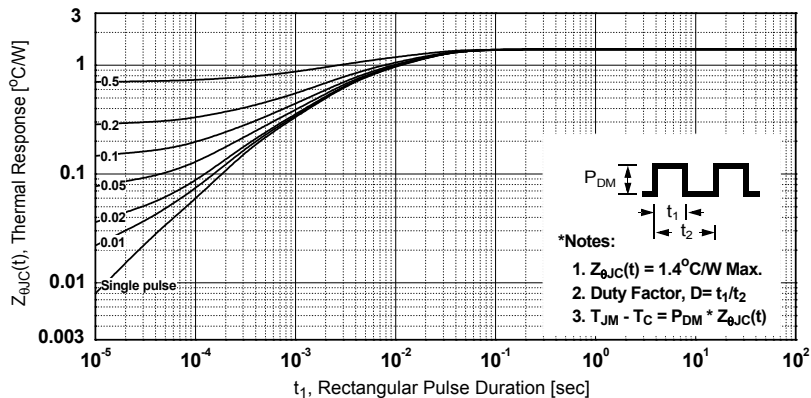
**Figure 8. Maximum Safe Operating Area**

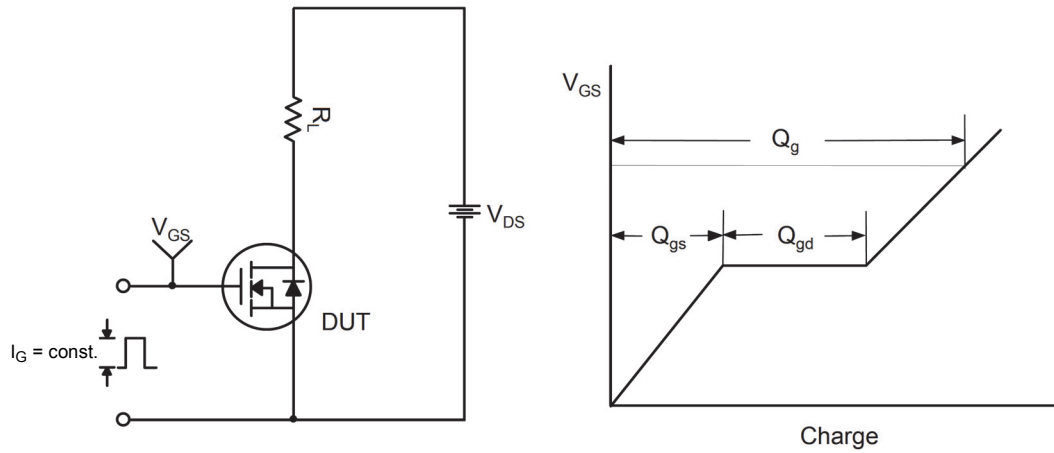


**Figure 9. Maximum Drain Current**

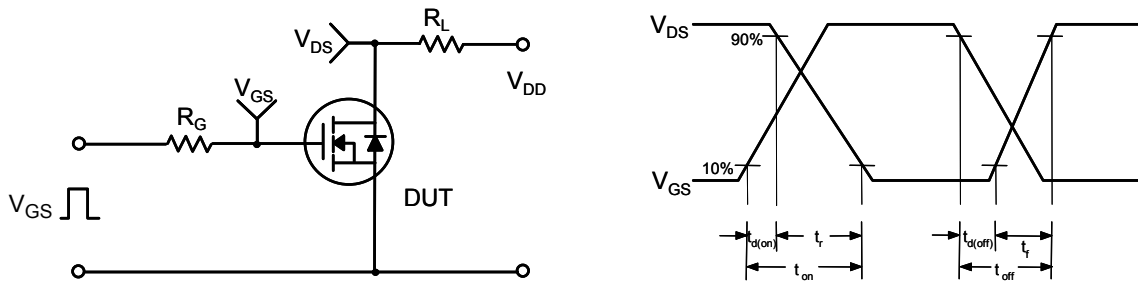


**Figure 10. Transient Thermal Response Curve**

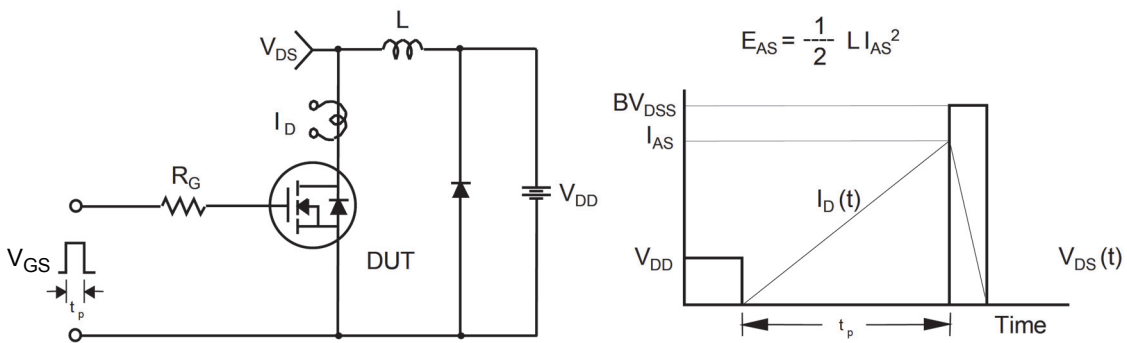




**Figure 11. Gate Charge Test Circuit & Waveform**



**Figure 12. Resistive Switching Test Circuit & Waveforms**



**Figure 13. Unclamped Inductive Switching Test Circuit & Waveforms**

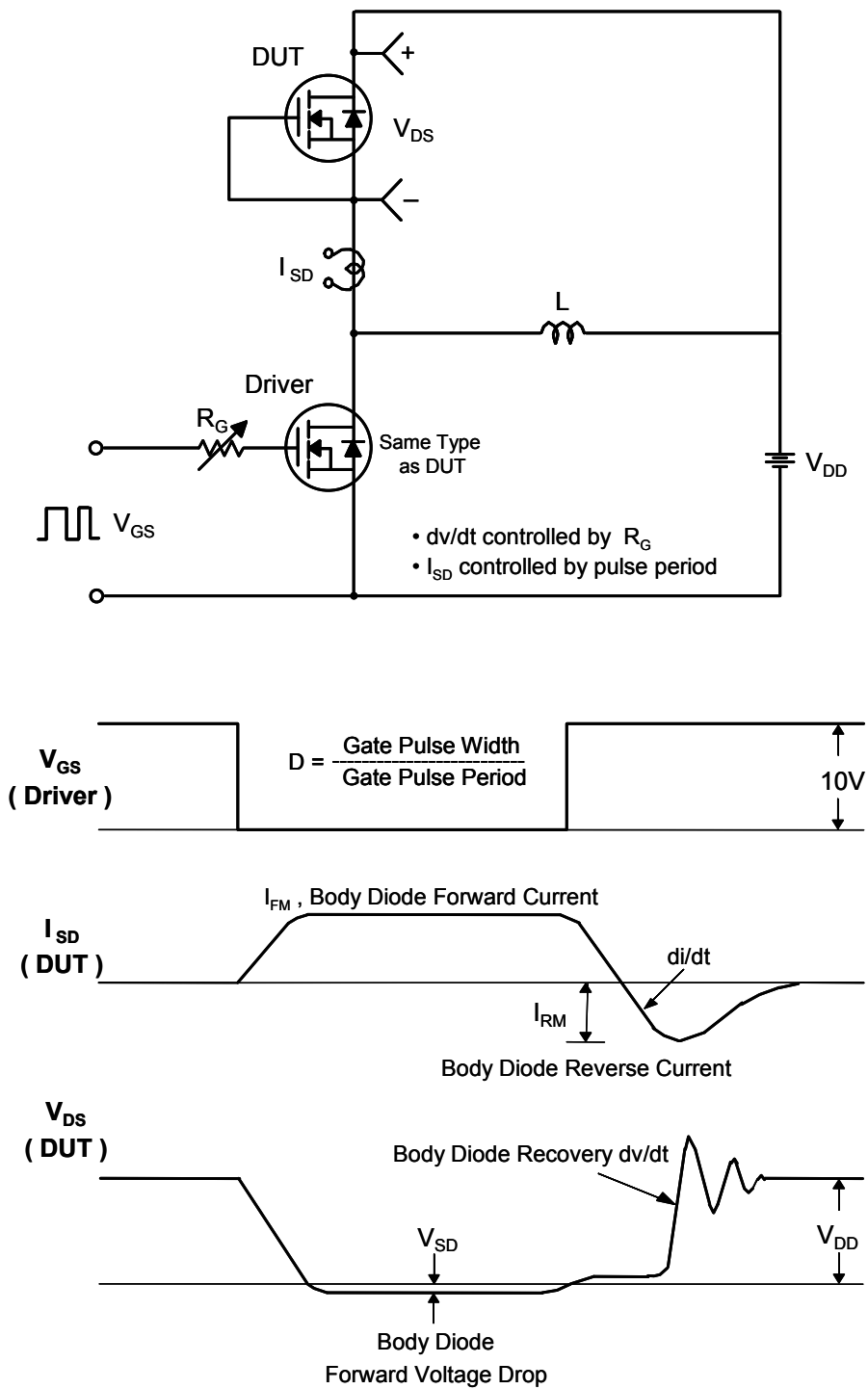


Figure 14. Peak Diode Recovery  $dv/dt$  Test Circuit & Waveforms

ON Semiconductor and  are trademarks of Semiconductor Components Industries, LLC dba ON Semiconductor or its subsidiaries in the United States and/or other countries. ON Semiconductor owns the rights to a number of patents, trademarks, copyrights, trade secrets, and other intellectual property. A listing of ON Semiconductor's product/patent coverage may be accessed at [www.onsemi.com/site/pdf/Patent-Marking.pdf](http://www.onsemi.com/site/pdf/Patent-Marking.pdf). ON Semiconductor reserves the right to make changes without further notice to any products herein. ON Semiconductor makes no warranty, representation or guarantee regarding the suitability of its products for any particular purpose, nor does ON Semiconductor assume any liability arising out of the application or use of any product or circuit, and specifically disclaims any and all liability, including without limitation special, consequential or incidental damages. Buyer is responsible for its products and applications using ON Semiconductor products, including compliance with all laws, regulations and safety requirements or standards, regardless of any support or applications information provided by ON Semiconductor. "Typical" parameters which may be provided in ON Semiconductor data sheets and/or specifications can and do vary in different applications and actual performance may vary over time. All operating parameters, including "Typicals" must be validated for each customer application by customer's technical experts. ON Semiconductor does not convey any license under its patent rights nor the rights of others. ON Semiconductor products are not designed, intended, or authorized for use as a critical component in life support systems or any FDA Class 3 medical devices or medical devices with a same or similar classification in a foreign jurisdiction or any devices intended for implantation in the human body. Should Buyer purchase or use ON Semiconductor products for any such unintended or unauthorized application, Buyer shall indemnify and hold ON Semiconductor and its officers, employees, subsidiaries, affiliates, and distributors harmless against all claims, costs, damages, and expenses, and reasonable attorney fees arising out of, directly or indirectly, any claim of personal injury or death associated with such unintended or unauthorized use, even if such claim alleges that ON Semiconductor was negligent regarding the design or manufacture of the part. ON Semiconductor is an Equal Opportunity/Affirmative Action Employer. This literature is subject to all applicable copyright laws and is not for resale in any manner.

## PUBLICATION ORDERING INFORMATION

### LITERATURE FULFILLMENT:

Literature Distribution Center for ON Semiconductor  
19521 E. 32nd Pkwy, Aurora, Colorado 80011 USA  
**Phone:** 303-675-2175 or 800-344-3860 Toll Free USA/Canada  
**Fax:** 303-675-2176 or 800-344-3867 Toll Free USA/Canada  
**Email:** [orderlit@onsemi.com](mailto:orderlit@onsemi.com)

**N. American Technical Support:** 800-282-9855 Toll Free  
USA/Canada  
**Europe, Middle East and Africa Technical Support:**  
Phone: 421 33 790 2910  
**Japan Customer Focus Center**  
Phone: 81-3-5817-1050

**ON Semiconductor Website:** [www.onsemi.com](http://www.onsemi.com)  
**Order Literature:** <http://www.onsemi.com/orderlit>  
For additional information, please contact your local  
Sales Representative