

PART No. 1485CW1

for more information visit
www.hammfg.com

Data subject to change without notice

Isometric drawing Not to Scale

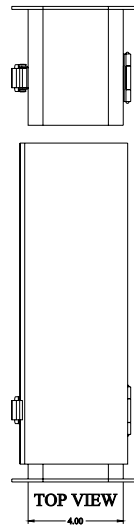

TOP VIEW
4.00

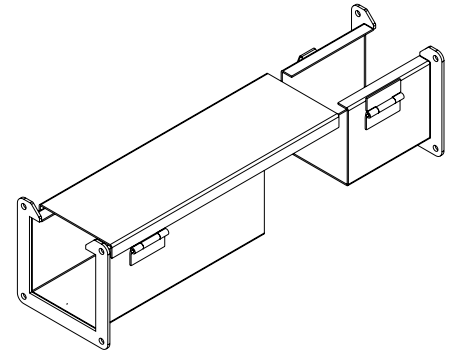

ISOMETRIC VIEW

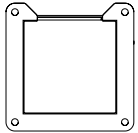

BACK VIEW

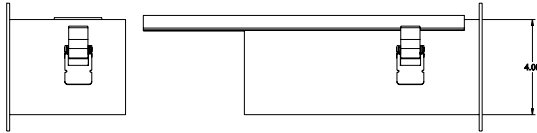

SIDE VIEW
4.00

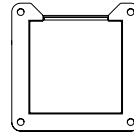

FRONT VIEW

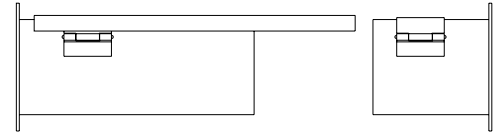

SIDE VIEW

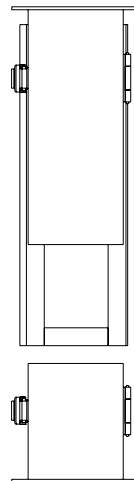

BOTTOM VIEW