

General Description

The MAX14713 evaluation kit (EV kit) is a fully assembled and tested circuit board that demonstrates the MAX14713 power path selector. To evaluate the MAX14714, request a sample from Maxim and replace the MAX14713 with the MAX14714.

EV Kit Contents

- MAX14713 EV Kit Board

Features

- 1.6V to 5.5V Operating Voltage Range
- Proven PCB Layout
- Fully Assembled and Tested

[Ordering Information](#) appears at end of data sheet.

Quick Start

Required Equipment

- MAX14713 EV kit
- 3V DC power supply
- Two 5V DC power supplies
- Multimeter

Procedure

The MAX14713 EV kit is fully assembled and tested. Follow these steps to verify board operation:

- 1) Verify that all jumpers are in their default positions.
- 2) Connect 3V DC supply to VIO. Turn on the power supply.
- 3) Connect one 5V DC supply to IN1. Connect one 5V DC supply to IN2.
- 4) Turn on IN1 supply. Verify LED1 is on and OUT is 5V.
- 5) Turn off IN1 supply. Verify LED1 is off.
- 6) Turn on IN2 supply. Verify LED1 is on and OUT is 5V.
- 7) Turn off IN2 supply. Verify LED1 is off.
- 8) Set IN1 to 4V and IN2 to 3.5V, and turn on both power supplies. Verify OUT goes to 4V.
- 9) Increase IN2 to 4.1V. Note that OUT is still 4V.
- 10) Slowly increase IN2. Verify OUT = IN2 when IN2 reaches ~4.2V.
- 11) After OUT = IN2. Decrease IN2 to 3.9V. Verify OUT = IN2 still.
- 12) Slowly decrease IN2. Verify OUT = IN1(4V) when IN2 reaches ~3.8V.

Detailed Description of Hardware

The MAX14713 EV kit is a fully assembled and tested circuit board demonstrating the MAX14713 power path selector IC in a 15-bump, surface-mount, wafer-level package (WLP).

The MAX14713 EV kit features an LED to indicate that input is powered from either channel 1 or 2.

Enable Inputs

Use JU1 and JU2 to enable the device. See [Table 1](#) for jumper settings.

Table 1. Enable Input Jumper Settings

JUMPER	SHUNT POSITION	DESCRIPTION
JU1	1-2	$\overline{EN1}$ is connected to VIO (TP6) through R1, channel 1 is disabled.
	2-3*	$\overline{EN1}$ is connected to GND through R1, channel 1 is enabled.
JU2	1-2	$\overline{EN2}$ is connected to VIO (TP6) through R2, channel 2 is disabled.
	2-3*	$\overline{EN2}$ is connected to GND through R2, channel 2 is enabled.

*Default position.

Table 2. Output Load Jumper Settings

JUMPER	SHUNT POSITION	DESCRIPTION
JU3	Installed	OUT is connected to R5, 10Ω.
	Not installed*	OUT is not connected to R5.
JU5	Installed	OUT is connected to R3, 1kΩ.
	Not installed*	OUT is not connected to R3.
JU7	Installed	OUT is connected to C4 and C5.
	Not installed*	OUT is not connected to C4 and C5.

*Default position.

Output Load

Use JU3, JU5, and JU7 to select output load. See [Table 2](#) for jumper settings.

VIO Power Source

Use JU6 to select the VIO power source. See [Table 3](#) for jumper settings.

LED Indicator

Use JU8 to enable the LED indicator. See [Table 4](#) for jumper settings.

Table 3. VIO Power Source Jumper Settings

JUMPER	SHUNT POSITION	DESCRIPTION
JU6	Installed	VIO is powered from either IN1 or IN2. Do not connect power on VIO (TP6) if shunt is installed.
	Not installed*	VIO is powered from TP6.

*Default position.

Table 4. LED Indicator Jumper Settings

JUMPER	SHUNT POSITION	DESCRIPTION
JU8	Installed*	LED1 is enabled. LED1 turns on when either IN1 or IN2 is powered.
	Not installed	LED1 is disabled.

*Default position.

MAX14713 EV Kit Bill of Materials

DESIGNATION	QTY	DESCRIPTION
C1–C3	3	1 μ F \pm 10%, 50V X5R ceramic capacitors (0805)
C4, C5	2	47 μ F \pm 10%, 16V tantalum capacitors
C6, C7	2	10 μ F \pm 10%, 25V X5R ceramic capacitors (1206)
C8–C27	20	DNI (2917)
D1, D2	2	75V 0.15A diodes, Diodes Incorporated 1N4148WS-7-F
JU1, JU2	2	3-pin single-row headers
JU3, JU5–JU8	5	2-pin single-row headers
LED1	1	Green LED
R1–R3, R6	4	1k Ω \pm 1% resistors (0805)
R5	1	10 Ω \pm 1% 5W resistor, Ohmite WNE10RFET
TB1–TB3	3	Terminal block
TP1, TP3, TP7–TP9	5	Black test points
TP2, TP4–TP6	4	Red test points
U1	1	Power path selector (15 WLP), Maxim MAX14713EWL+
—	7	Shunts
—	1	PCB: MAX14713 EVKIT

MAX14713 EV Kit Schematic

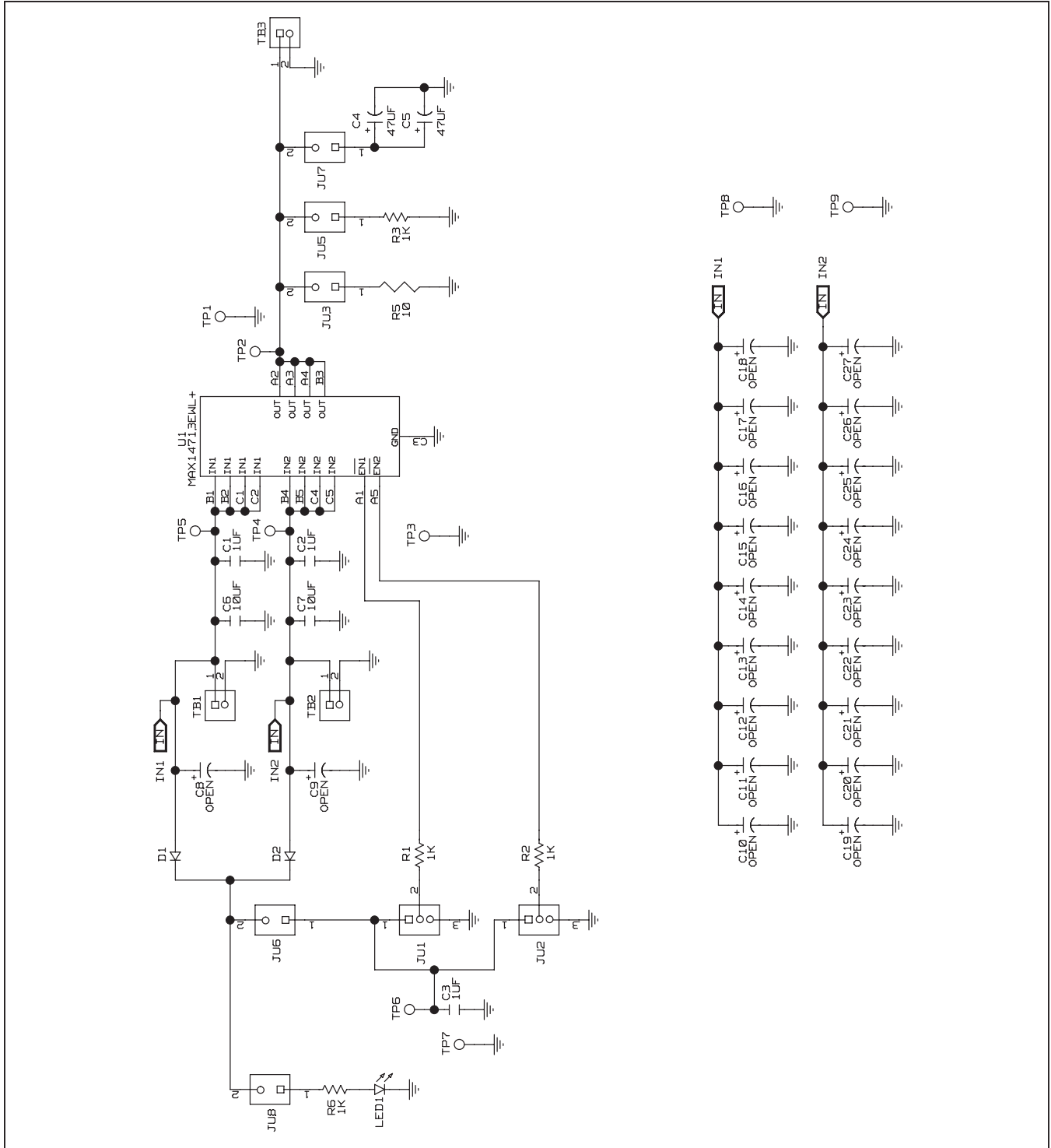

MAX14713 EV Kit PCB Layout Diagrams

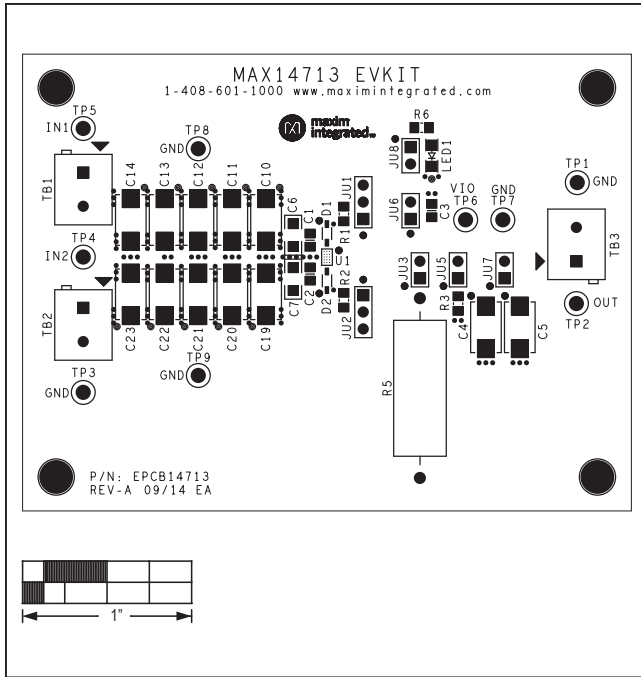

MAX14713 EV Kit Component Placement Guide—Component Side

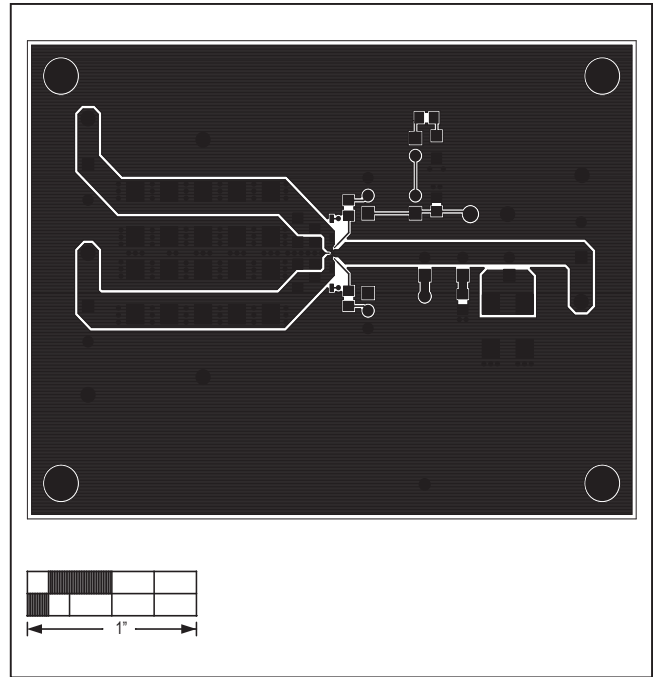

MAX14713 EV Kit PCB Layout—Component Side

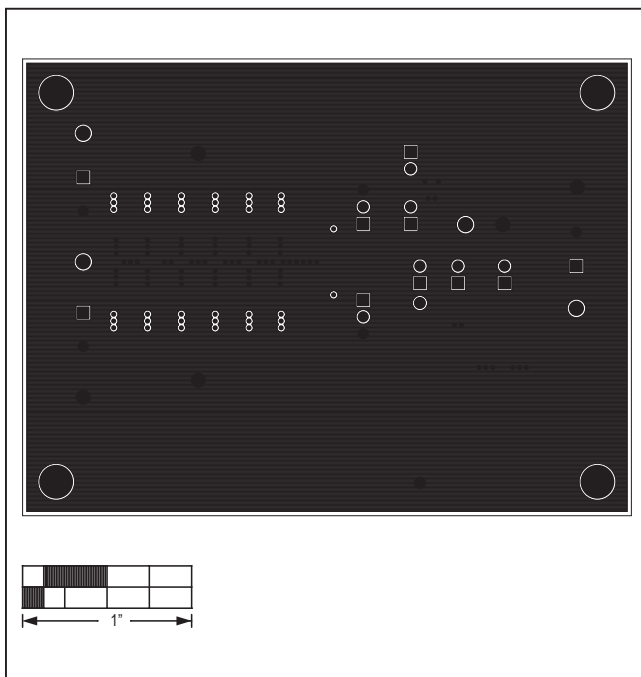

MAX14713 EV Kit PCB Layout—Internal Layer 1

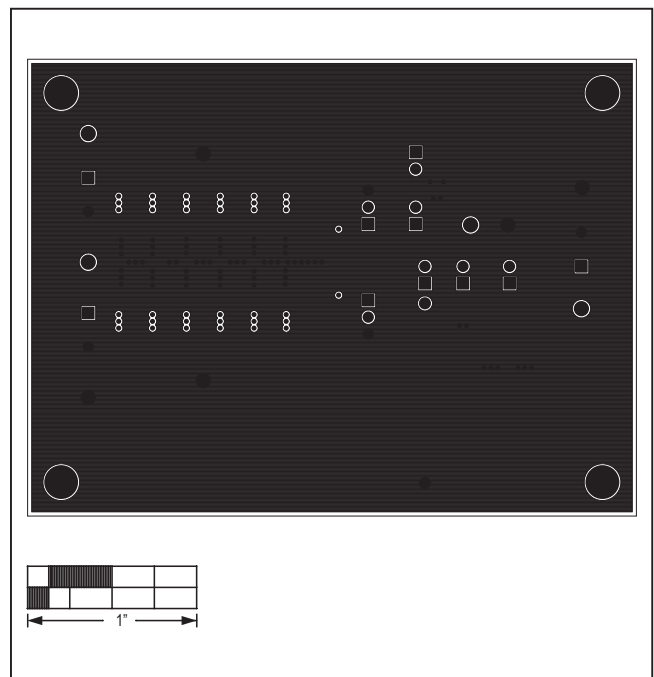

MAX14713 EV Kit PCB Layout—Internal Layer 2

MAX14713 EV Kit PCB Layout Diagrams (continued)

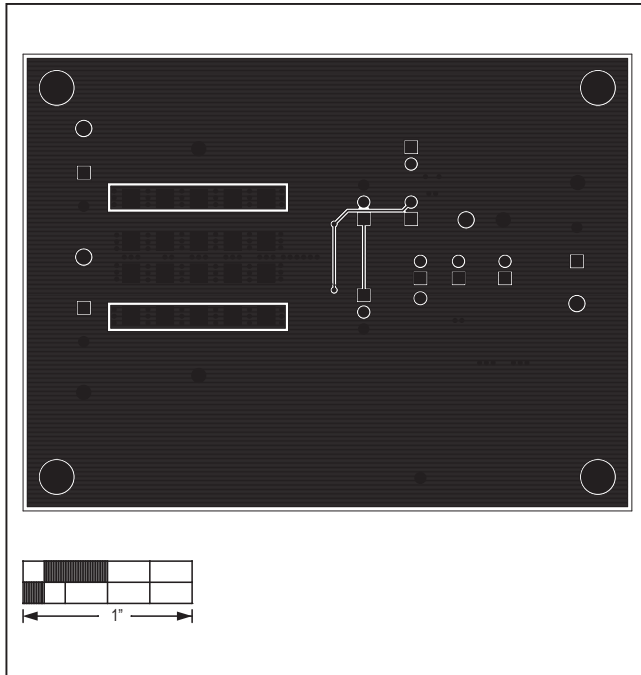

MAX14713 EV Kit PCB Layout—Solder Side

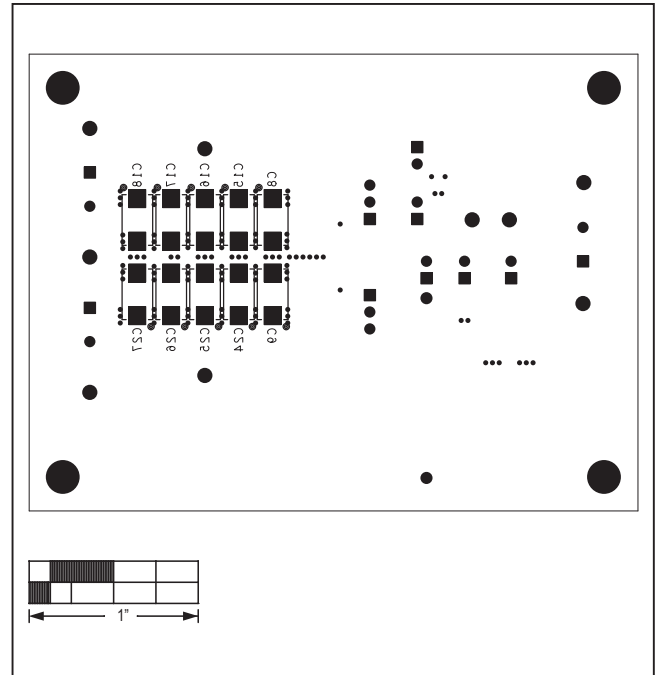

MAX14713 EV Kit Component Placement Guide—Solder Side

Ordering Information

PART	TYPE
MAX14713EVKIT#	EV Kit

#Denotes lead(Pb)-free and RoHS compliant.

Revision History

REVISION NUMBER	REVISION DATE	DESCRIPTION	PAGES CHANGED
0	2/17	Initial release	—
1	8/17	Added MAX14714 to data sheet title	1–7

Maxim Integrated cannot assume responsibility for use of any circuitry other than circuitry entirely embodied in a Maxim Integrated product. No circuit patent licenses are implied. Maxim Integrated reserves the right to change the circuitry and specifications without notice at any time.