

Features

DIN Rail Series

- Universal AC Input (85-264VAC)
- Protections: SCP, OVP, OLP, OTP
- DC OK Indicator LED with Relay Contacts
- 150% (360W) peak load capacity
- Built-in active PFC, PF>0.95
- High efficiency up to 94%

Description

These DIN-rail mounted power supplies have a robust case, 4mm screw terminal connectors and use high reliability components to give a long, trouble-free life. The REDIN240 can be end mounted to save rail space or side mounted for use in low-profile cabinets. The units can deliver up to 150% start-up power and allow n+1 parallel operation to increase the continuous output current or for supply redundancy. Relay contacts simplify DC OK monitoring. The REDIN240 series is designed for demanding commercial and industrial applications with UL508, UL60950, IEC60950 CB report and CE (LVD + EMC + RoHS) certifications. They come with a full 5-year warranty.

Selection Guide

Part Number	nom. Input Voltage Range [VAC]	Output Voltage [VDC]	Output Adjustability [VDC]	Rated Current [A]	Efficiency typ. [%]
REDIN240-24	100-240	24	24-28	10	94.35
REDIN240-48	100-240	48	48-56	5	93.7

Specifications (measured @ ta = 25°C, rated Vin, rated load and after warm up)

BASIC CHARACTERISTICS					
Parameter	Condition		Min.	Typ.	Max.
Input Voltage Range			85VAC		264VAC
Absolute Maximum Input Voltage	max. 3 seconds				300VAC 375VDC
Input Current	full load, 115VAC full load, 230VAC			2.28A 1.13A	3.0A 1.5A
Inrush Current	cold start at 25°C, 115VAC cold start at 25°C, 230VAC			15A 32A	20A 40A
No Load Power Consumption	85-264VAC 230VAC			2.2W 1.8W	4W 3W
Input Frequency Range			47Hz		63Hz
Output Trim	24Vout 48Vout		24V 48V		28V 56V
Power Factor	115VAC 230VAC			0.99 0.95	
Start-up time	24Vout	115VAC 230VAC		1.48s 1.27s	3s
	48Vout	115VAC 230VAC		1.45s 1.25s	
Hold-up time	24Vout	230VAC	20ms	26.28ms	
	48Vout		20ms	24.74ms	
Rise time	24Vout	230VAC		16.62ms	100ms
	48Vout			26.27ms	
Ripple & Noise ⁽¹⁾	0 - 70°C	24Vout			240mVp-p
	-25°C				480mVp-p
	-25 - 70°C		48Vout		

Notes:

Note1: Measured at 20MHz bandwidth by using a 12" twisted pair-wire terminated with a 0.1µF & 10µF parallel capacitor.

continued on next page

RECOM
AC/DC Converter

REDIN240

240 Watt DIN-Rail Power Supply



UL60950-1 Certified
UL508 Certified
IEC/EN60950-1 Certified

Specifications (measured @ $t_a = 25^\circ\text{C}$, rated V_{in} , rated load and after warm up)

REDIN240-24

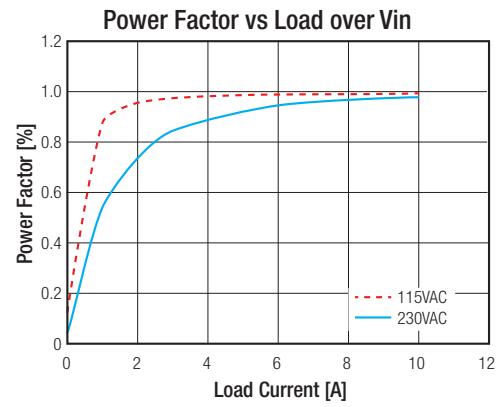
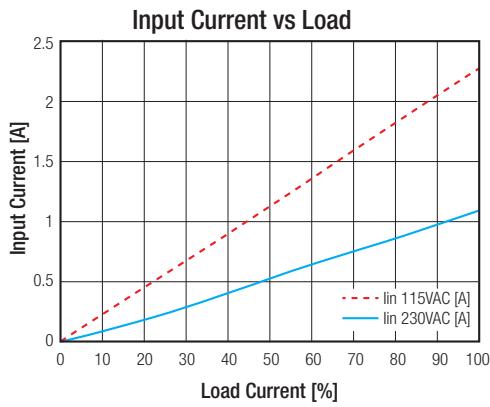
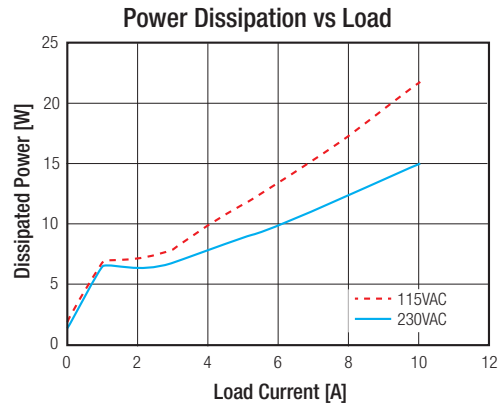
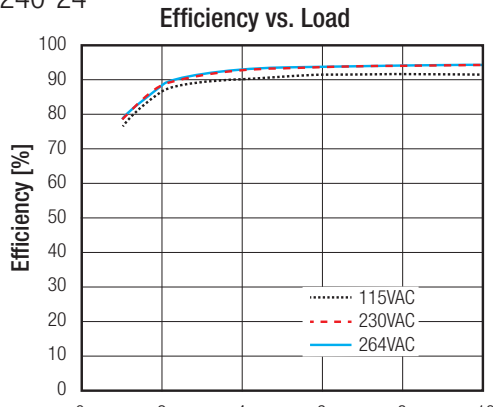

REDIN240-48

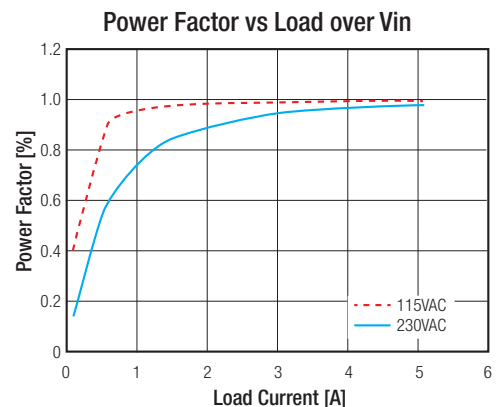
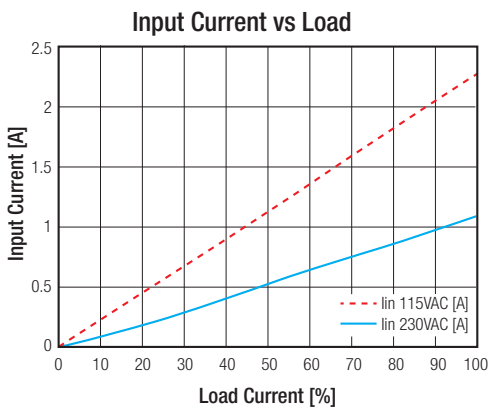
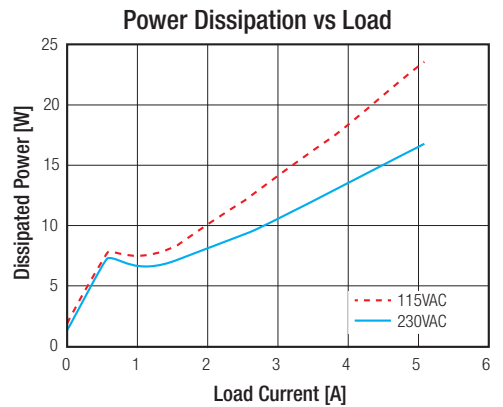
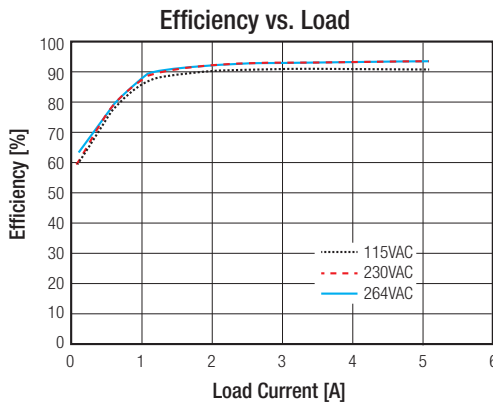

Specifications (measured @ $t_a = 25^\circ\text{C}$, rated V_{in} , rated load and after warm up)

REGULATION		
Parameter	Condition	Value
Output Accuracy	24Vout	$\pm 0.4\%$ typ. / $\pm 3\%$ max.
	48Vout	$\pm 0.3\%$ typ. / $\pm 3\%$ max.
Line Regulation	24Vout	$\pm 0.03\%$ typ. / $\pm 0.5\%$ max.
	48Vout	$\pm 0.04\%$ typ. / $\pm 0.5\%$ max.
Load Regulation	0% to 100% load	$\pm 0.3\%$ typ. / $\pm 1.0\%$ max.
Transient Response	100Hz & 1kHz, 50% duty, 25% load step change	$\pm 1\%$ typ. / $\pm 5\%$ max.

PROTECTION		
Parameter	Condition	Value
Input Fuse		T5A, slow blow type
Short Circuit Protection (SCP)		continuous, auto recovery
Over Voltage Protection (OVP)	24Vout	29-33VDC, constant voltage auto recovery
	48Vout	58-63VDC, constant voltage auto recovery
Over Voltage Category (OVC)		OVC II
Over Load Protection (OLP)		Limit the current by constant power circuit
Over Temperature Protection (OTP)		$105 \pm 5^\circ\text{C}$, detect on Heat-sink of power transistor; shut down O/P, auto recovery after temperature goes down
Isolation Voltage	I/P to O/P	3.0KVAC / 1minute
	I/P to PE	2.5KVAC / 1minute
	O/P to PE	0.5KVAC / 1minute
Isolation Resistance		10M Ω min.
Leakage Current	I/P to O/P	0.25mA max.
	I/P to PE	3.5mA max.
Power OK LED	ON	Vout up to 90% of rated Vout
	OFF	Vout down to 80% of rated Vout
	Relay Contact Rating	Max. 30V/1A or 60V/0.3 or 30VAC/0.3A Resistive Load

Overload Capability

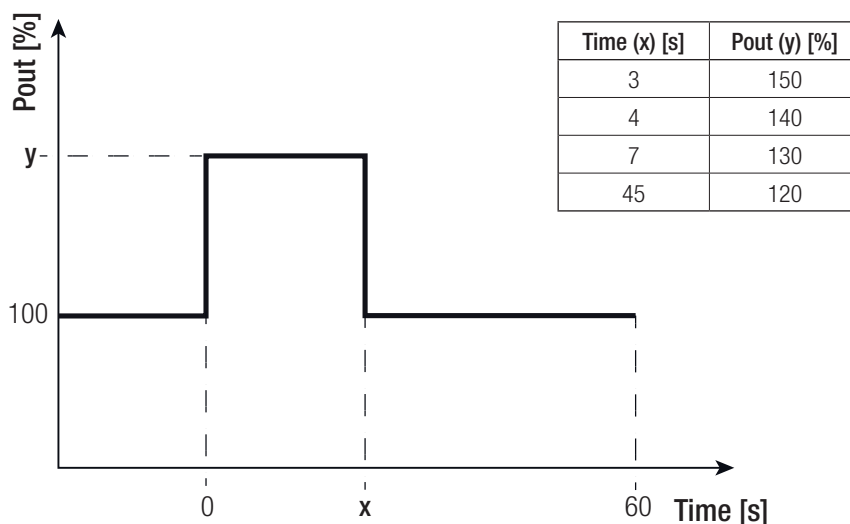

Specifications (measured @ $t_a = 25^\circ\text{C}$, rated V_{in} , rated load and after warm up)

ENVIRONMENTAL		
Parameter	Condition	Value
Operating Temperature Range	with derating	-25°C to +70°C
Temperature Coefficient		±0.3%/°C
Operating Altitude		3000m
Operating Humidity	non-condensing	20% - 90% RH
IP Rating		IP X0
Pollution Degree (PD)		PD 2
Shock		10-500Hz 2G, 60min.
Vibration		10G /11ms, along x,y and z axis
MTBF	MIL-HDBK-217F, full load, 25°C	300 x 10 ³ hours

Thermal Derating

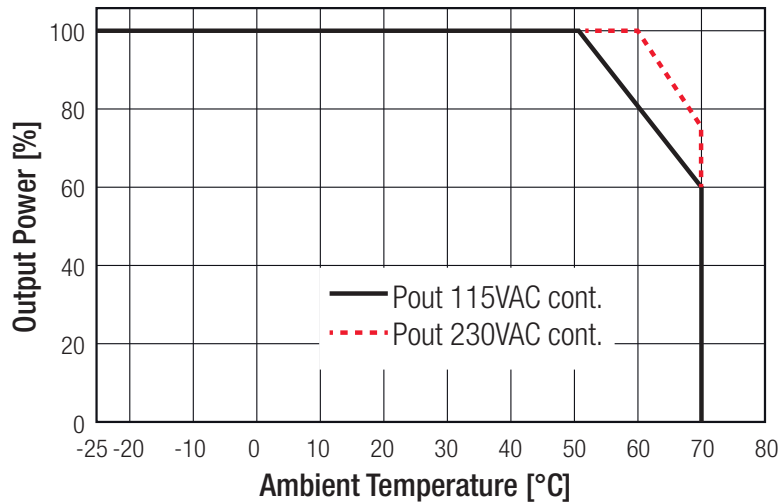

SAFETY AND CERTIFICATIONS		
Certificate Type	Report / File Number	Standard
Information Technology Equipment, General Requirements for Safety	E224736	UL60950-1, 2nd Edition, 2014 CSA C22.2 No. 60950-1-07, 2nd Edition, 2014
Industrial Control Equipment	E470721	UL508, 17th Edition, 2013 CSA C22.2 No. 107.1-01, 3rd Edition, 2011
Information Technology Equipment - General Requirements for Safety	NTEK-2016NT02244417S	IEC60950-1, 2nd Edition 2005, +AM1:2009 + AM2:2013 EN60950-1:2006, + A11:2009 + A1:2010 + A12:2011 + A2:2013
EMC Compliance	Report / Condition	Standard / Criterion
Information technology equipment - Radio disturbance characteristics - Limits and methods of measurement		EN55022:2010 + AC:2011, Class B
Information technology equipment - Immunity characteristics - Limits and methods of measurement		EN55024:2010 + A1:2015
Limitations on the amount of electromagnetic interference allowed from digital and electronic devices		47 CFR FCC Part 15, Subpart B: 2016
ESD Electrostatic discharge immunity test	Air ±8kV, Contact ±4kV	EN61000-4-2, Criteria B, 2009
Radiated, radio-frequency, electromagnetic field immunity test	3V/m	EN61000-4-3, Criteria A, 2006

continued on next page

Specifications (measured @ ta = 25°C, rated Vin, rated load and after warm up)

Fast Transient and Burst Immunity	AC Power Port: L+N+PE ±1kV	EN61000-4-4, Criteria B, 2012
Surge Immunity	AC Power Port L-N ±1kV, L-PE + N-PE ±2kV	EN61000-4-5, Criteria B, 2014
Immunity to conducted disturbances, induced by radio-frequency fields	AC Power Port 3V	EN61000-4-6, Criteria A, 2014
Power Magnetic Field Immunity	50Hz, 1A/m	EN61000-4-8, Criteria A, 2010
Voltage Dips and Interruptions	Voltage Dips >95% Voltage Dips 30% Voltage Interruptions >95%	EN61000-4-11, Criteria B, 2004 EN61000-4-11, Criteria C, 2004 EN61000-4-11, Criteria C, 2004
Limits of Harmonic Current Emissions		EN61000-3-2, Criteria A, 2014
Voltage Fluctuations & Flicker		EN61000-3-3, Clause 5, 2013

DIMENSION and PHYSICAL CHARACTERISTICS

Parameter	Type	Value
Material	Case Cover	Aluminium Nickel plated steel
Package Dimension (LxWxH)	without mounting clip	114.26 x 46.0 x 124.4mm
Package Weight		810g typ.

Dimension Drawing (mm)

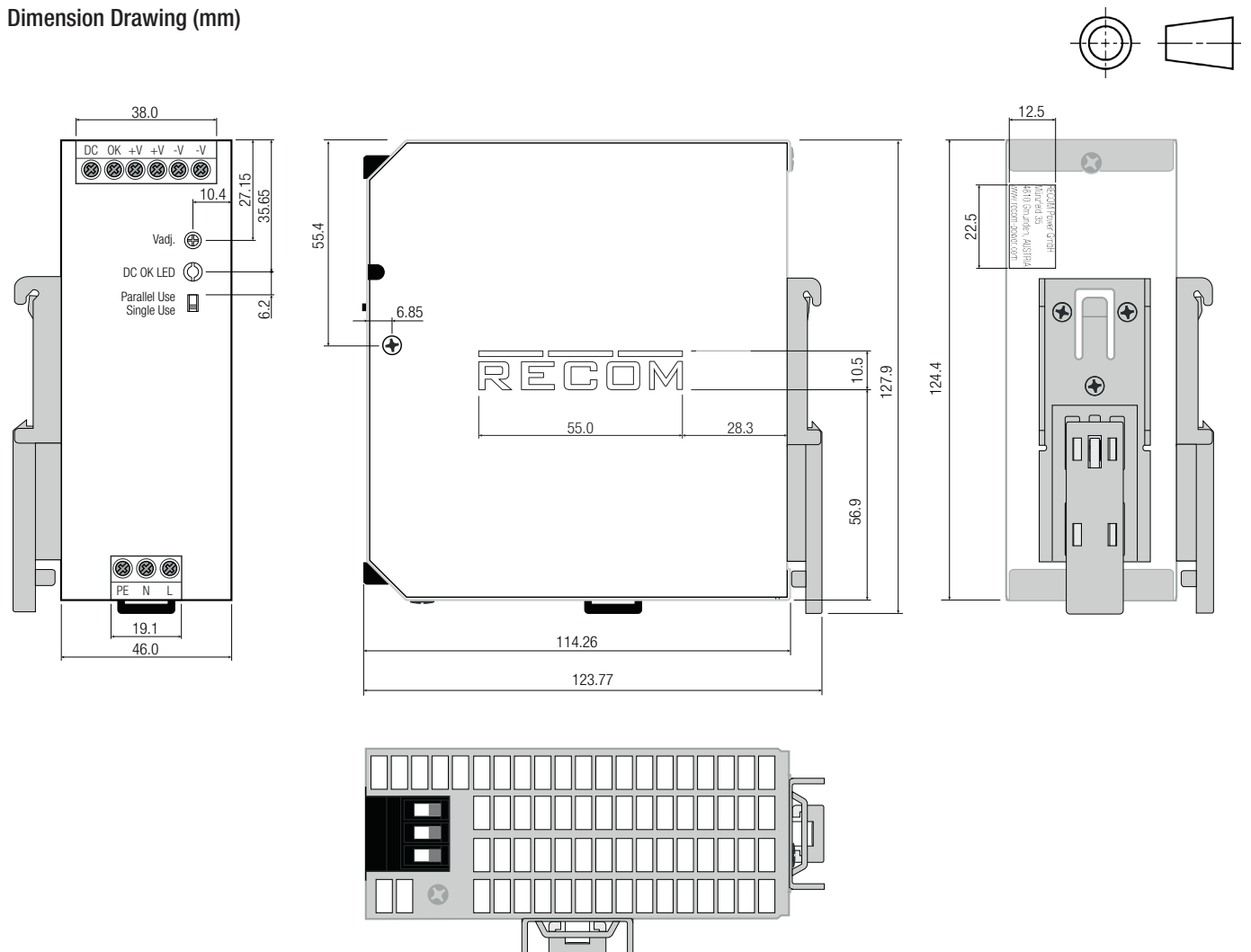

continued on next page

Specifications (measured @ $t_a = 25^\circ\text{C}$, rated V_{in} , rated load and after warm up)

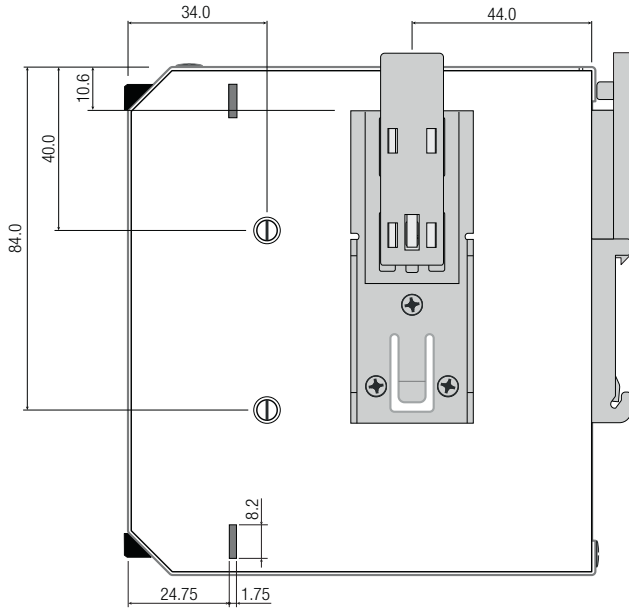

Terminals and Wiring	
Type	Screw Connector
Solid Wire	1-6mm ²
Stranded Wire	1-4mm ²
American Wire Gauge	AWG17-10
Wire Stripping Length	8mm
Screwdriver (slotted / cross)	3.5mm
Recommended tightening torque	0.5Nm-0.8Nm
Tolerance: X.X ±0.5mm X.XX ±0.25mm	

INSTALLATION

Mounting Instruction

Mounting

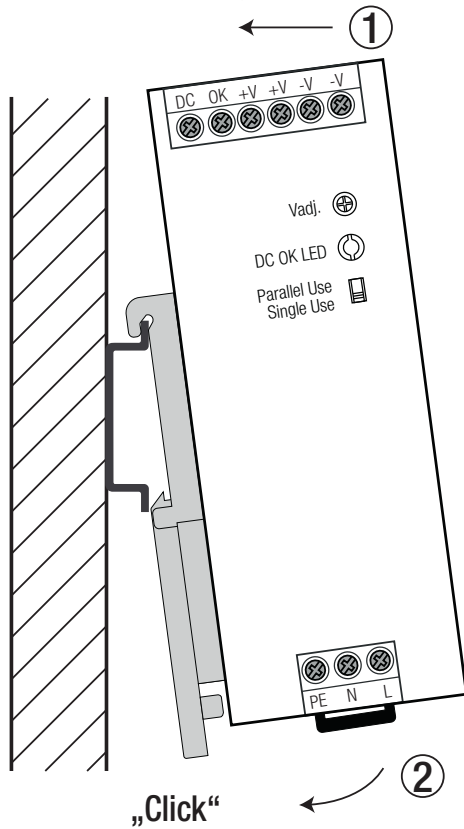

Releasing

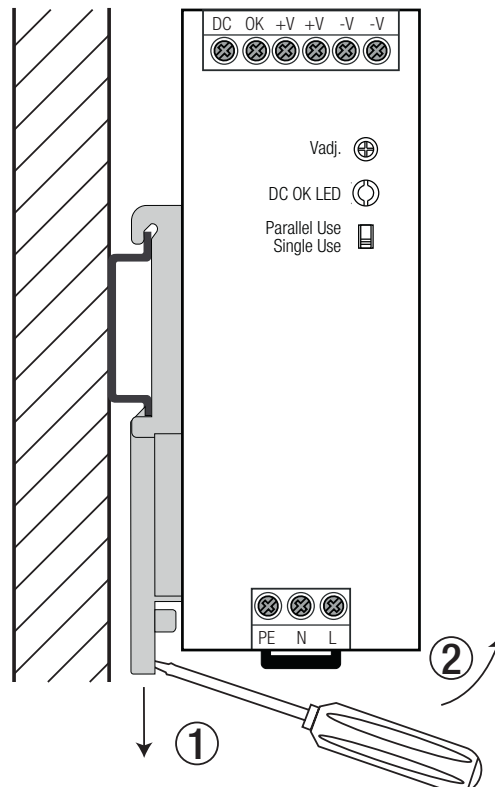

Specifications (measured @ $t_a = 25^\circ\text{C}$, rated V_{in} , rated load and after warm up)

INSTALLATION

Mounting Multiple Power Supplies

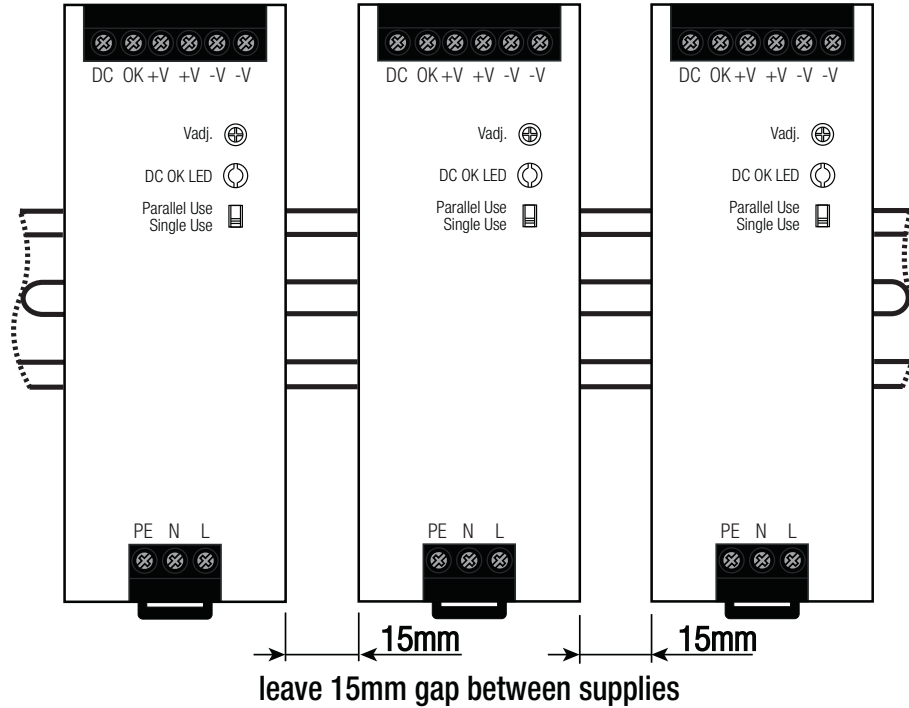

Parallel Operation & Phase Redundancy

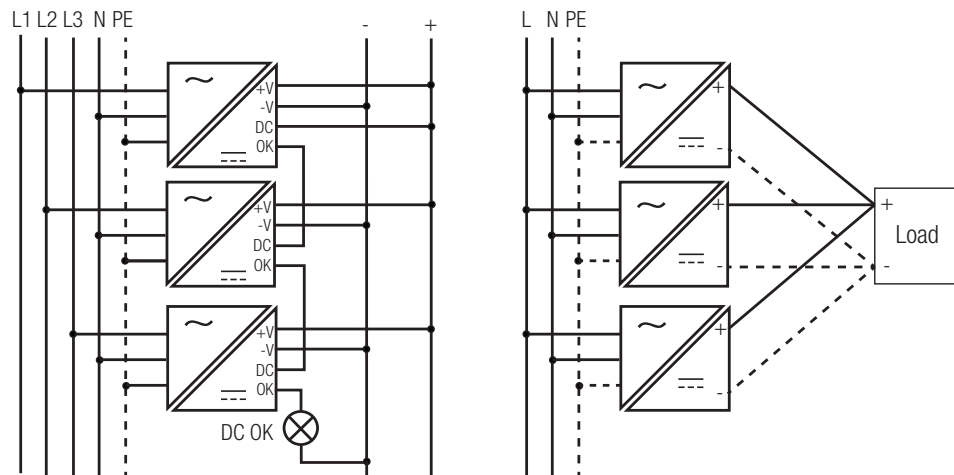

Single Operation:

- 1) Make sure that the front panel switch is set to "single Use."
- 2) The output voltage can be increased by trim pot to compensate any cable losses.

Parallel Operation:

- 1) Make sure that the front panel switch is set to "single Use" on each power supply.
- 2) Adjust each power supply to the exact same output voltage with same load and cooling conditions.
- 3) Set the front panel switches to "Parallel Use." Use the same wire length for each power supply (star connection) and energize all units at the same time to avoid triggering overload protection.

Derate the maximum output power to 90% of nominal ratings.

For operation with more than three power supplies in parallel or series operation, please contact RECOM technical support for advice.

Specifications (measured @ $t_a = 25^\circ\text{C}$, rated V_{in} , rated load and after warm up)

Application Circuit

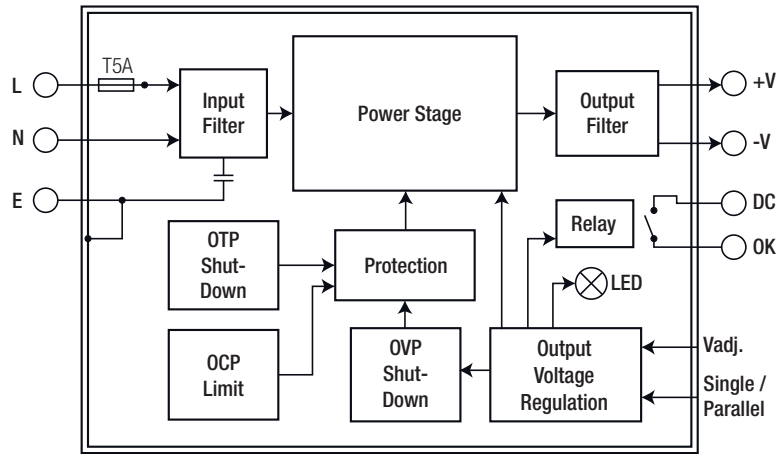

PACKAGING INFORMATION

Parameter	Type	Value
Packaging Dimension (LxWxH)	cardboard box	140.0 x 63.0 x 142.0mm
Packaging Quantity	cardboard box	1pcs
Storage Temperature Range		-40°C to +85°C
Storage Humidity		5% - 95% RH

The product information and specifications are subject to change without prior notice. RECOM products are not authorized for use in safety-critical applications (such as life support) without RECOM's explicit written consent. A safety-critical application is defined as an application where a failure of a RECOM product may reasonably be expected to endanger or cause loss of life, inflict bodily harm or damage property. The buyer shall indemnify and hold harmless RECOM, its affiliated companies and its representatives against any damage claims in connection with the unauthorized use of RECOM products in such safety-critical applications.