

FEATURES

- Dedicated single-chip integrated dual cell battery management
- 4.5V-5.5V input voltage and 3.4A input current limit
- 5.07V+/-1% output with prioritized power path from input to output
- 20V input Voltage Protection
- 2.4A+1.0A dual outputs with CC regulation
- Pass MFi test
- Meet EN55022 class B radiated EMI standard
- Output short circuit protection and nearly zero power
- Output over voltage protection
- Dual cell battery charger with cell balancing management
- Dual cell battery overcharge, over discharge, over charge current and over discharge current protections
- >91% charge efficiency at 3.4A input
- >92% discharge efficiency at 3.4A output
- Configurable charge, discharge and HZ modes
- Output plug-in detection to wakeup
- Light load detection
- <10uA low battery drainage current
- Battery operation voltage 6.0V-8.4V
- Battery termination voltage 8.4V for dual cell
- 4 LED battery level indication
- Preconditioning for deeply depleted battery
- Built-in charge and discharge safety timer
- 4.20V/4.35V +/- 0.5% battery charge voltage accuracy of each cell
- Optimized power path and battery charge control
- Thermal regulation for battery charge/discharge
- Accommodation for >10mA input source
- Battery over voltage protection
- TQFN5x5-40

TABLE OF CONTENT

1	DEMO BOARD PHOTOS	3
2	PCB LAYOUT	3
3	SCHEMATICS	4
4	BILL OF MATERIALS	5
5	FUNCTIONAL TEST	6
5.1	BATTERY CHARGE V/I PROFILE.....	6
5.2	POWER PATH FUNCTION	7
5.3	CHARGE EFFICIENCY.....	7
5.4	BUCK EFFICIENCY AND POWER LOSS (TA=25°C)	8
5.5	BUCK CONSTANT CURRENT AND CONSTANT VOLTAGE REGULATION (TA=25°C)	9
5.6	BATTERY LEAKAGE CURRENT IN HZ MODE	11
5.7	RIPPLE AND NOISE	11
5.8	LOAD DYNAMIC RESPONSE LOAD STEP.....	11
5.9	LED INDICATION	12
5.10	SYSTEM MANAGEMENT.....	13
5.11	KEY COMPONENTS TEMPERATURE TEST (TA=25C, BURNING FOR 2 HOURS)	14
6	EMI TEST	15

1 DEMO BOARD PHOTOS

(DEMO BOARD SIZE: 48mm*31mm)

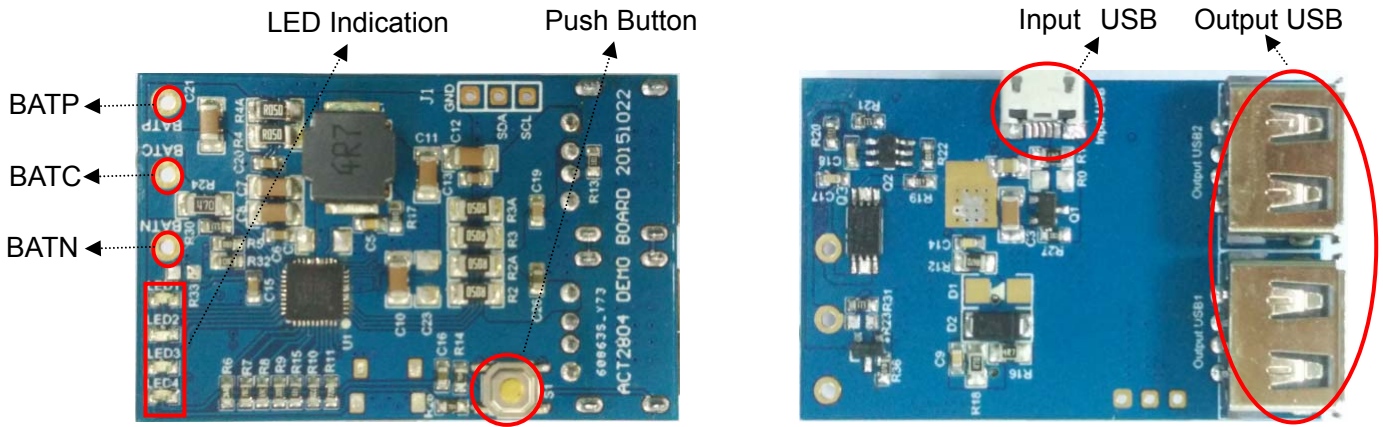

2 PCB LAYOUT

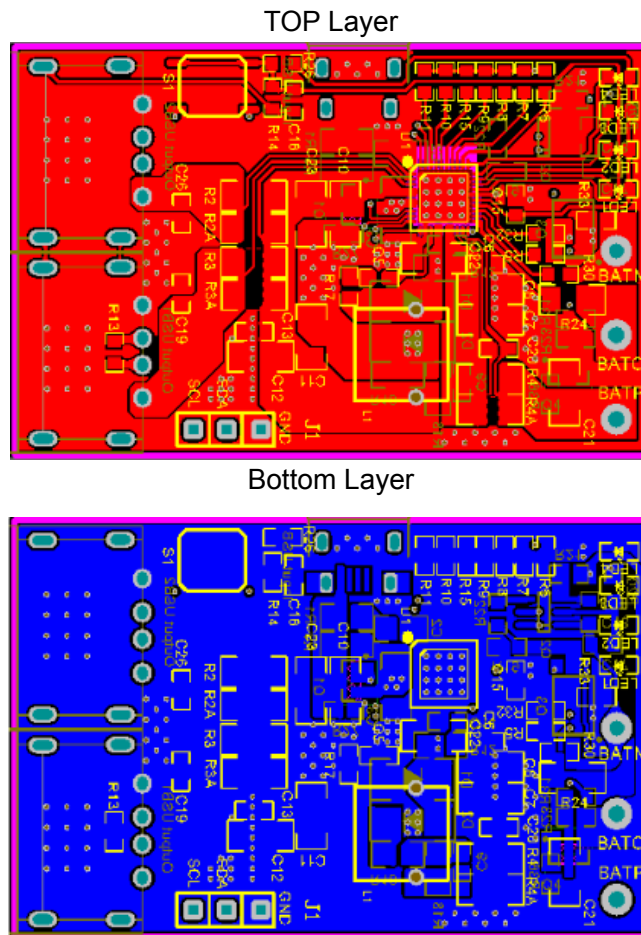

3 SCHEMATICS

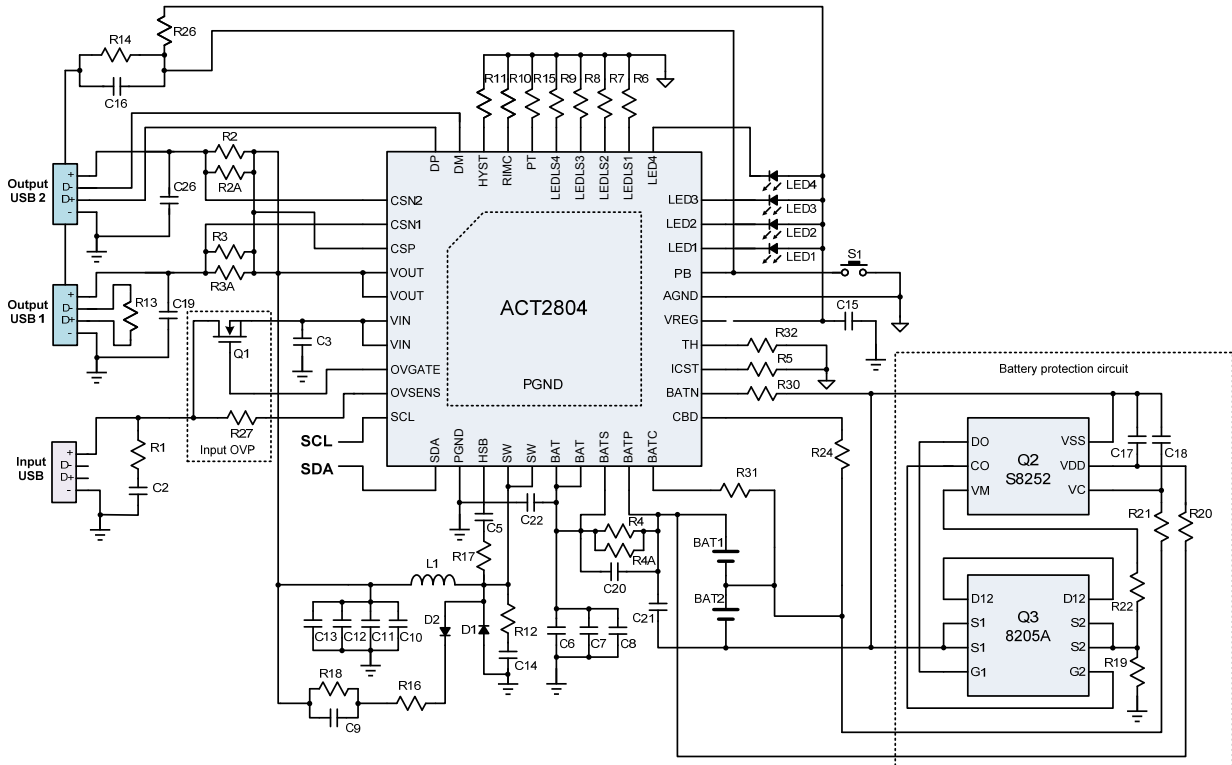

Application information

Charge Current Setting:

$$I_c(A) = \frac{8}{R_{icst}(K\Omega)}$$

LED Indication:

MODE	TRIG	LED1	LED2	LED3	LED4
CHARGE	HIGH	$V_{LED1} + V_{IMC} + 0.6 * V_{HYST}$	$V_{LED2} + V_{IMC} + 0.6 * V_{HYST}$	$V_{LED3} + V_{IMC} + 0.6 * V_{HYST}$	$V_{LED4} + V_{IMC} + 0.6 * V_{HYST}$
	LOW	$V_{LED1} + V_{IMC} - 100mV$	$V_{LED2} + V_{IMC} - 100mV$	$V_{LED3} + V_{IMC} - 100mV$	$V_{LED4} + V_{IMC} - 100mV$
DISCHARGE	HIGH	$V_{LED1} - V_{IMC} + 100mV$	$V_{LED2} - V_{IMC} + 100mV$	$V_{LED3} - V_{IMC} + 100mV$	$V_{LED4} - V_{IMC} + 100mV$
	LOW	$V_{LED1} - V_{IMC} - 0.6 * V_{HYST}$	$V_{LED2} - V_{IMC} - 0.6 * V_{HYST}$	$V_{LED3} - V_{IMC} - 0.6 * V_{HYST}$	$V_{LED4} - V_{IMC} - 0.6 * V_{HYST}$

$$V_{LED(x)}(A) = 5.5V + \frac{108K}{R_{LS(x)}(K\Omega)}$$

$$V_{IMC}(V) = 2106K * I_{BAT}(A) * \frac{R_{CS}(\Omega)}{R_{IMC}(K\Omega)}$$

$$V_{HYST(4:3)} = \frac{54K}{R_{HYST}(K\Omega)}$$

4 BILL OF MATERIALS

Item	Reference	Description	QTY	Manufacturer
1	L1	SWPA8040S4R7NT, 4.7uH 5.9A(8*8*4mm)	1	Sunlord
2	D1	MBR1020VL, 20V/1A Schottky, SMA, Optional	1	Panjit
3	D2	MBR1020VL, 20V/1A Schottky, SMA	1	Panjit
4	C2	Ceramic capacitor, 4.7uF/10V, X7R, 0805	1	Murata/TDK
5	C3, C10,C11,C12	Ceramic capacitor, 10uF/10V, X7R, 1206	4	Murata/TDK
6	C7,C8, C21, C22	Ceramic capacitor, 22uF/16V, X7R, 1206	4	Murata/TDK
7	C5,C9	Ceramic capacitor, 47nF/16V, X7R, 0603	2	Murata/TDK
8	C6,C13	Ceramic capacitor, 0.1uF/16V, X7R, 0603	2	Murata/TDK
9	C14	Ceramic capacitor, 2.2nF/16V, X7R, 0603	1	Murata/TDK
10	C15	Ceramic capacitor, 1uF/10V, X7R, 0603	1	Murata/TDK
11	C16	Ceramic capacitor, 2.2uF/10V, X7R, 0603	1	Murata/TDK
12	C17,C18	Ceramic capacitor, 0.22uF/10V, X7R, 0603	1	Murata/TDK
11	C19, C26	Ceramic capacitor, 3.3uF/10V, X7R, 0603	2	Murata/TDK
13	C20	Ceramic capacitor, 100nF/10V, X7R, 0603	1	Murata/TDK
16	R1	Chip Resistor, 2.7Ω, 1/8W, 5%, 0805	1	Murata/TDK
17	R2,R2A,R3,R3A,R4, R4A	Chip Resistor, 50mΩ, 1/2W, 1%, 1206	6	Sart
18	R5	Chip Resistor, 8kΩ, 1/10W, 1%, 0603	1	Murata/TDK
19	R6	Chip Resistor, 83kΩ, 1/10W, 1%, 0603	1	Murata/TDK
20	R7	Chip Resistor, 63.5kΩ, 1/10W, 1%, 0603	1	Murata/TDK
21	R8	Chip Resistor, 51.4kΩ, 1/10W, 1%, 0603	1	Murata/TDK
22	R9	Chip Resistor, 41.5kΩ, 1/10W, 1%, 0603	1	Murata/TDK
23	R10,R11	Chip Resistor, 540kΩ, 1/10W, 1%, 0603	2	Murata/TDK
24	R12	Chip Resistor, 0.47Ω, 1/8W, 1%, 0805	1	Murata/TDK
25	R13	Chip Resistor, 200Ω, 1/10W, 1%, 0603	1	Murata/TDK
26	R14,R26	Chip Resistor, 715K, 1/10W, 5%, 0603	2	Murata/TDK
27	R15	Chip Resistor, 12K, 1/10W, 1%, 0603	1	Murata/TDK
28	R16	Chip Resistor, 4.7Ω, 1/8W, 1%, 0805	1	Murata/TDK
29	R17	Chip Resistor, 10Ω, 1/10W, 5%, 0603	1	Murata/TDK
30	R18	Chip Resistor, 47Ω, 1/8W, 5%, 0805	1	Murata/TDK
31	R19	Chip Resistor, 0.01Ω, 1/10W, 1%, 0603	1	Murata/TDK
32	R20,R21,R30,R31	Chip Resistor, 510Ω, 1/10W, 5%, 0603	4	Murata/TDK

33	R22	Chip Resistor, 1K, 1/10W, 5%, 0603	1	Murata/TDK
34	R24	Chip Resistor, 47Ω, 1/4W, 1%, 1206	1	Murata/TDK
35	R27	Chip Resistor, 100Ω, 1/10W, 1%, 0603	1	Murata/TDK
36	R32	Chip Resistor, 10K, 1/10W, 5%, 0603	1	Murata/TDK
37	LED1,LED2,LED3,LED4	LED, 0603, Blue	4	LED Manu
38	Q1	SSF2318, 20V/6.5A N MOSFET, Optional	1	Silikron
39	Q2	2S Battery protection IC, S8252	1	Seiko
40	Q3	20V Dual N-Channel Power MOSFET, 8205A	1	Fortune
41	PB	Push button	1	
42	Output USB1, Output USB2	10.2*14.6*7mm,4P	2	
43	Micro-USB	MICRO USB 5P/F SMT B	1	
44	U1	IC, ACT2804 T-QFN 5X5-40	1	ACT

5 FUNCTIONAL TEST

5.1 Battery Charge V/I profile

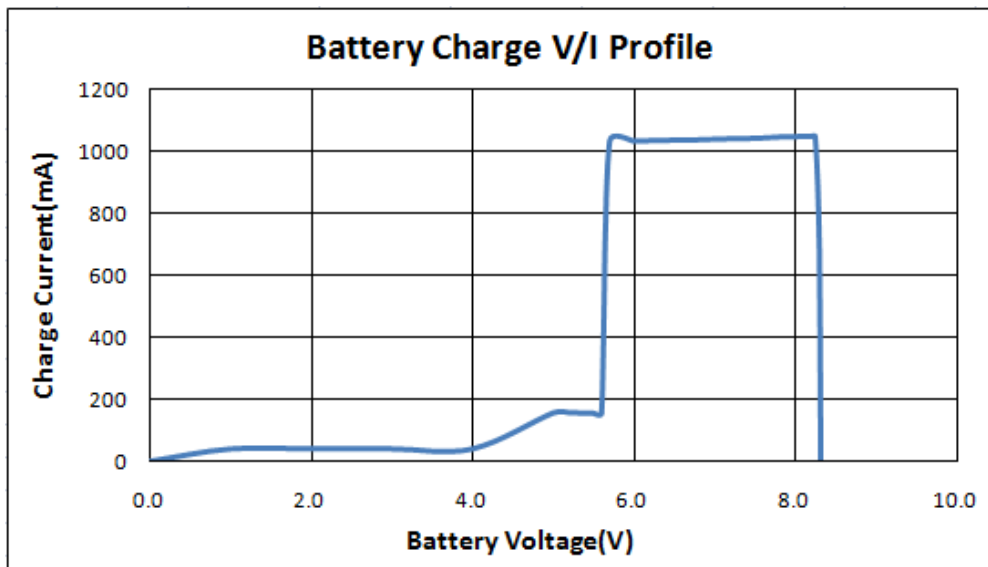

5.2 Power Path Function

(Test condition: $V_{in}=5.05V$, $V_{bat}=7V$, input current limit=3.4A, fast charge current=1.0A)

Input current(mA)	1540	1759	1965	2161	2369	2563	2752	2774	2772	2771	2769	2766	2743
Output current(mA)	0	200	400	600	800	1000	1200	1300	1500	1700	2000	2400	2728
Charge current(mA)	976	973	970	970	968	967	963	913	792	666	473	209	0

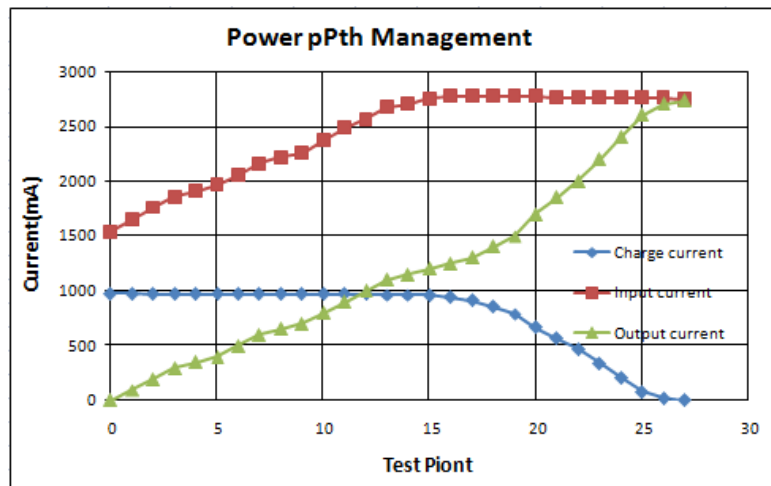

5.3 Charge Efficiency

($V_{in}=5V$ and charge current set at 1000mA)

Battery voltage (V)	6.0	6.5	7.0	7.5	8.0	8.2
Efficiency (%)	95.9	95.3	94.1	93.1	92.1	91.7

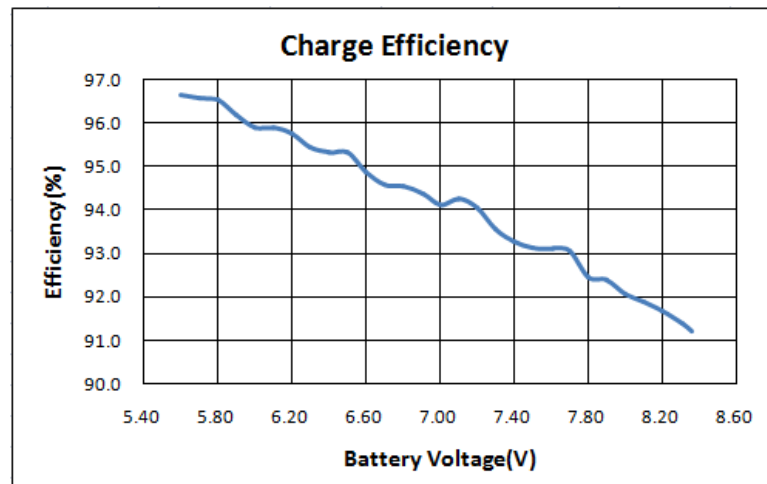

5.4 Buck Efficiency and Power Loss (Ta=25°C)

Vbat	Efficiency (%)				
	Io=1000mA	Io=1500mA	Io=2000mA	Io=2400mA	Io=3400mA
6.0V	95.6	94.7	93.9	92.9	91.1
7.0V	94.6	94.1	93.2	92.5	90.8
8.4V	91.7	92.0	91.7	91.2	90.1

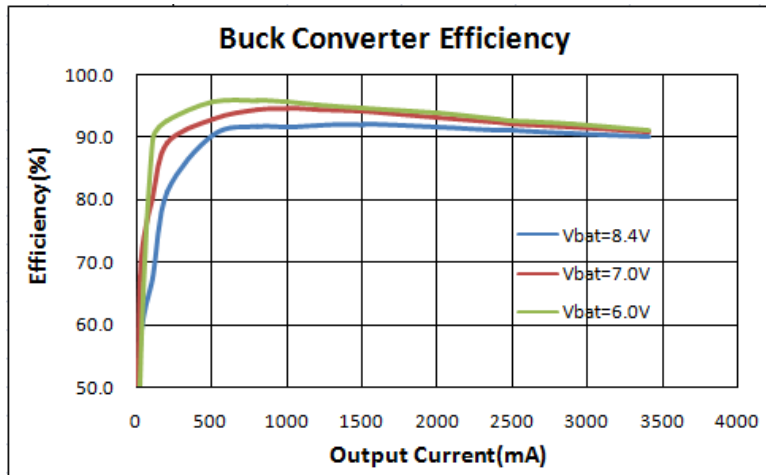

Vbat	Power Loss (W)				
	Io=1000mA	Io=1500mA	Io=2000mA	Io=2400mA	Io=3400mA
6.0V	0.23	0.42	0.65	0.91	1.67
7.0V	0.29	0.47	0.73	0.98	1.73
8.4V	0.46	0.65	0.91	1.16	1.88

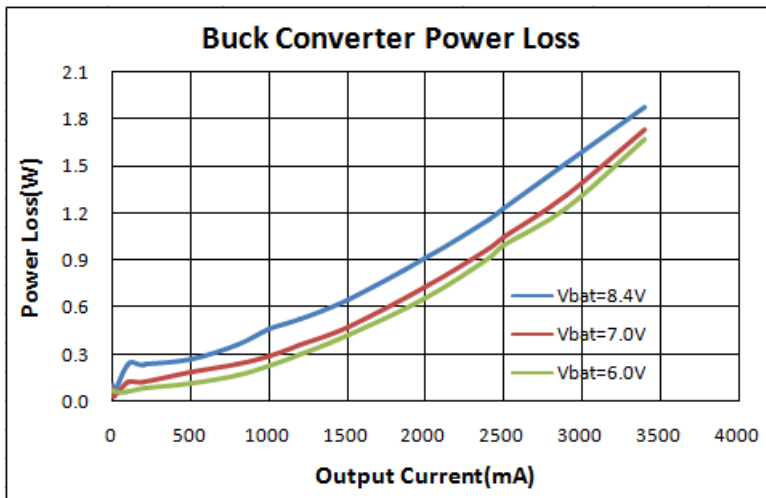

5.5 Buck Constant Current and Constant Voltage Regulation (Ta=25°C)

Buck V/I Profile (Output1)

	Vbat=6.0V		Vbat=7.0V		Vbat=8.0V	
	Vout(V)	Iout(mA)	Vout (V)	Iout(mA)	Vout(V)	Iout(mA)
CC Load	5.23	0	5.23	0	5.23	0
	5.24	12	5.08	12	5.08	12
	5.07	200	5.07	200	5.07	200
	5.06	500	5.06	500	5.06	500
	5.04	800	5.04	800	5.04	800
	5.04	1000	5.04	1000	5.04	1000
CV Load	5.00	1281	5.00	1281	5.00	1278
	4.9	1281	4.9	1280	4.9	1277
	4.8	1280	4.8	1280	4.8	1277
	4.6	1280	4.6	1280	4.6	1277
	4.4	1280	4.4	1280	4.4	1276
	4.2	1280	4.2	1280	4.2	1276
	4	1280	4	1280	4	1276
	3.9	1280	3.9	1280	3.9	1276
	3.8	1280	3.8	1280	3.8	1276
	3.7	1280	3.7	1280	3.7	1276
	3.6	1280	3.6	1280	3.6	1276
	3.5	0	3.5	0	3.5	0

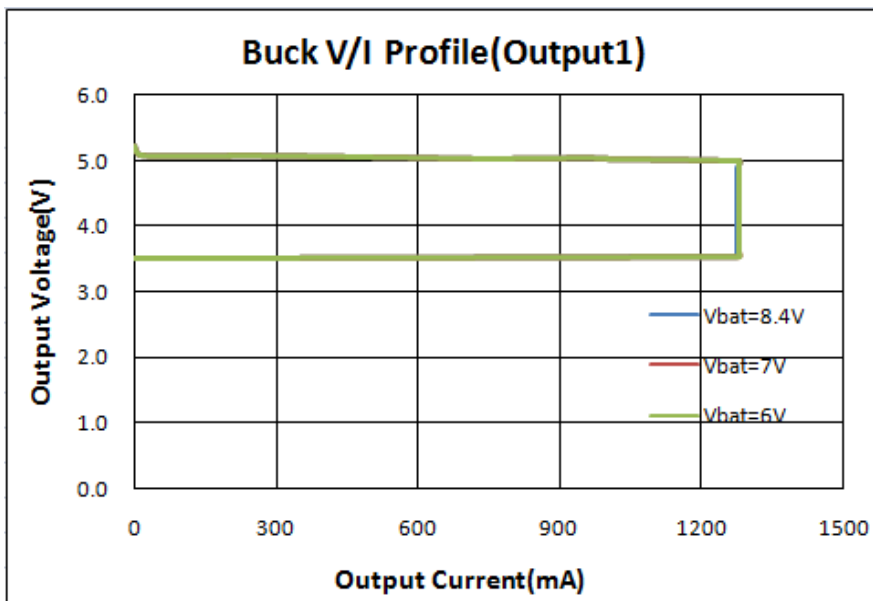

Buck V/I Profile (Output2)

	Vbat=6.0V		Vbat=7.0V		Vbat=8.0V	
	Vout(V)	Iout(mA)	Vout (V)	Iout(mA)	Vout(V)	Iout(mA)
CC Load	5.23	0	5.23	0	5.23	0
	5.08	12	5.08	10	5.08	10
	5.02	1000	5.02	1000	5.01	1000
	4.99	1500	4.99	1500	4.98	1500
	4.96	2000	4.97	2000	4.96	2000
	4.94	2400	4.95	2400	4.94	22400
CV Load	4.92	2682	4.92	2692	4.92	2630
	4.9	2681	4.9	2687	4.9	2675
	4.8	2677	4.8	2685	4.8	2680
	4.6	2676	4.6	2683	4.6	2678
	4.4	2675	4.4	2681	4.4	2677
	4.2	2674	4.2	2679	4.2	2676
	4	2673	4	2677	4	2675
	3.9	2672	3.9	2676	3.9	2674
	3.8	2672	3.8	2675	3.8	2672
	3.7	2671	3.7	2674	3.7	2671
	3.6	2671	3.6	2674	3.6	2670
	3.5	2671	3.5	2673	3.5	2668
	3.4	0	3.4	0	3.4	0

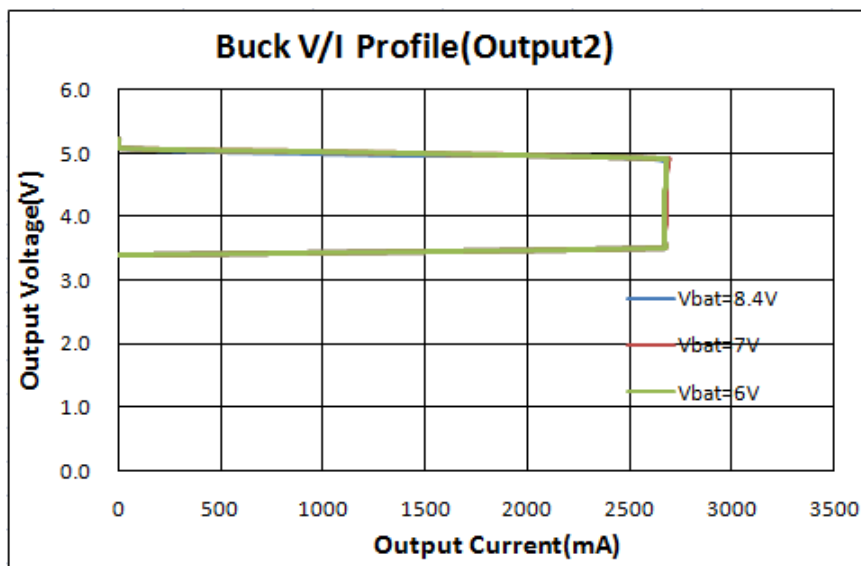

5.6 Battery Leakage Current in HZ Mode

Test Conditions	Battery Input Current (μA)	Power Loss (μW)
Vbat=6V	2.5	15
Vbat=7V	2.6	18.2
Vbat=8V	2.8	22.4
Vbat=8.4V	3.1	26

5.7 Ripple and Noise

Ripple & noise are measured by using 20MHz bandwidth limited oscilloscope.

Test Conditions	Output Ripple at 2.4A Load (mV)	Output Ripple at 3.4A Load (mV)
Vbat=6.0V	45	50
Vbat=7.0V	40	50
Vbat=8.4V	40	45

5.8 Load Dynamic Response Load Step

(Output2=80mA-1A-80mA load step Ouput1=0A)

Vbat=8V

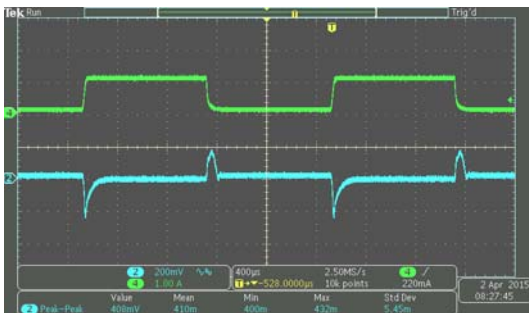

Vbat=6.6V

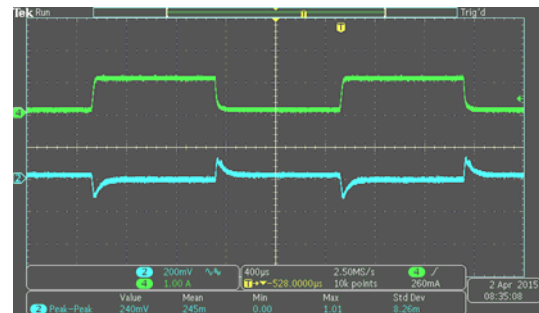

(Output2=1A-2.4A-1A load step Ouput1=0A)

Vbat=8V

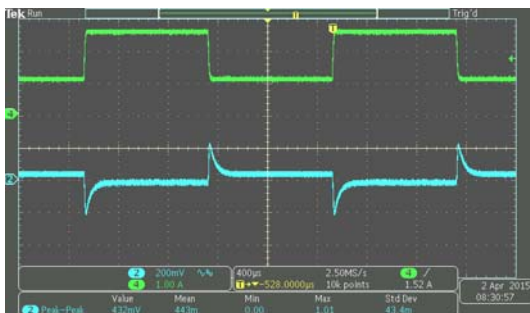

Vbat=6.6V

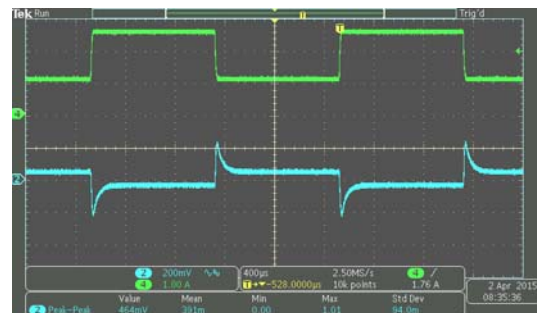

(Output2=80mA-1A-80mA load step Ouput1=1A)

Vbat=8V

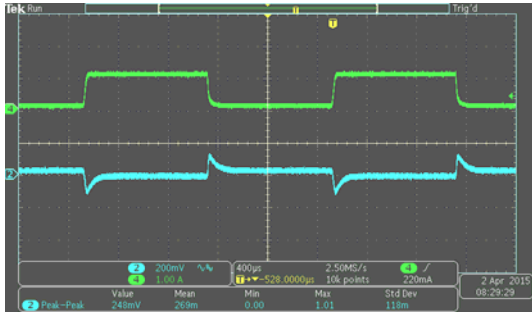

Vbat=6.6V

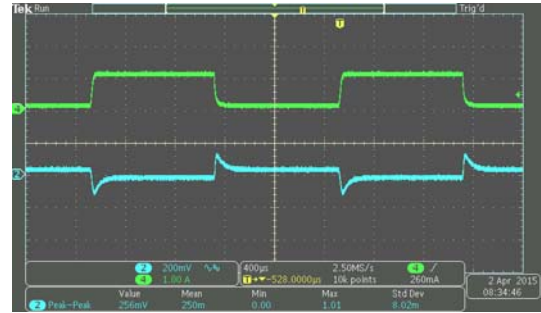

(Output2=1A-2.4A-1A load step Ouput1=1A)

Vbat=8V

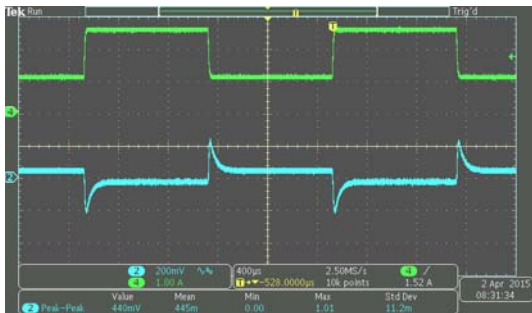

Vbat=6.6V

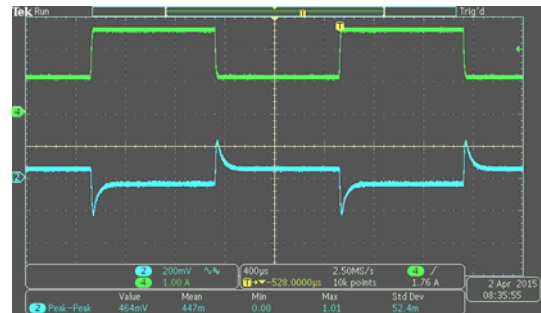

5.9 LED Indication

Conventional LED indication

PB time>40ms (HZ Mode)	LED1	LED2	LED3	LED4
VBAT<Vcut-off	Off	Off	Off	Off
Vcut-off ≤ VBAT < VLED1	Flash	Off	Off	Off
VLED1 ≤ VBAT < VLED2	On	Off	Off	Off
VLED2 ≤ VBAT < VLED3	On	On	Off	Off
VLED3 ≤ VBAT < VLED4	On	On	On	Off
VBAT ≥ VLED4	On	On	On	On

Charge Mode	LED1	LED2	LED3	LED4
VBAT < VLED2	Flash	Off	Off	Off
VLED2 ≤ VBAT < VLED3	On	Flash	Off	Off
VLED3 ≤ VBAT < VLED4	On	On	Flash	Off
VLED4 ≤ VBAT Charge Mode	On	On	On	Flash
VLED4 ≤ VBAT EOC Mode	On	On	On	On

ACT2804 is designed with a simple ADC to convert 5 levels of PT pin voltage into 5 application patterns.

INDICATION PATTERN	PT Resistor
Conventional Always On In Discharge	R15=3.3K
Conventional 5s Indication in Discharge	R15=12K
Breathing 5s Indication in Discharge	R15=24K
Bottom Charging 5s Indication in Discharge	R15=42K
Circulating 5s Indication in Discharge	R15=68K

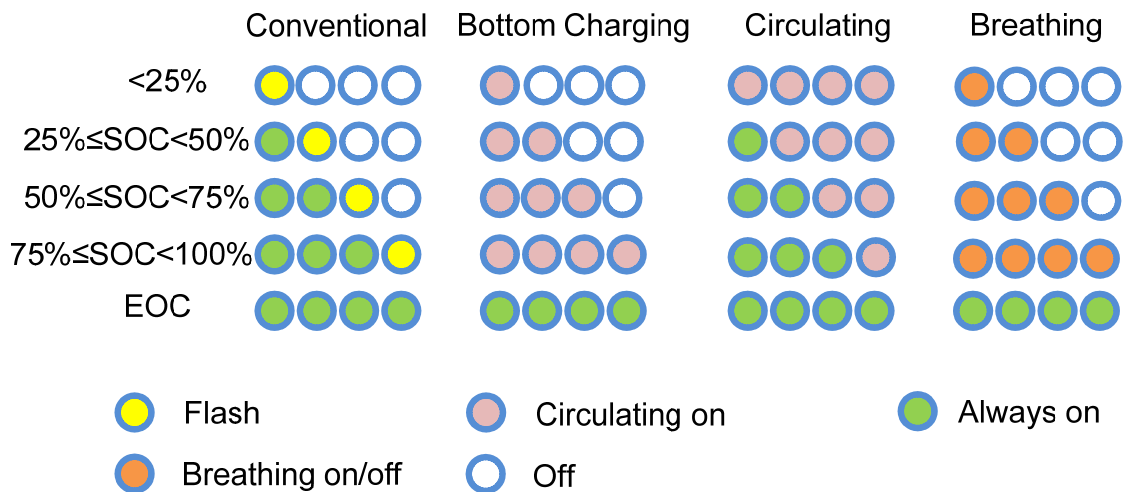

5.10 System Management

- PB is pressed for >5s or Discharge load is <10mA for 12.5s, Discharge mode is go into HZ mode
- PB is pressed for 40ms, Discharge mode is turned on
- PB is pressed for 40ms, LED indication is on for 5.0 seconds
- 2 seconds transition time between Charge Mode and Boost Mode

5.11 Key Components Temperature Test (Ta=25C, burning for 2 hours)

Charge mode, 1.0A charge current

Vin(V)	IC(°C)	Inductor(°C)	Vbat(V)
5.0	36.5	34.3	6
5.0	45.4	41.8	7.5
5.0	51.6	46.6	8.2

Discharge mode, 3.4A output current

Vbat(V)	IC(°C)	Inductor(°C)	Vout(V)
6	69.3	62	5.0
7.5	76.6	65.8	5.0
8.2	78.5	67.1	5.0

6 EMI TEST

Vbat=7.8V, Output: 5.07V/3.4A Horizontal

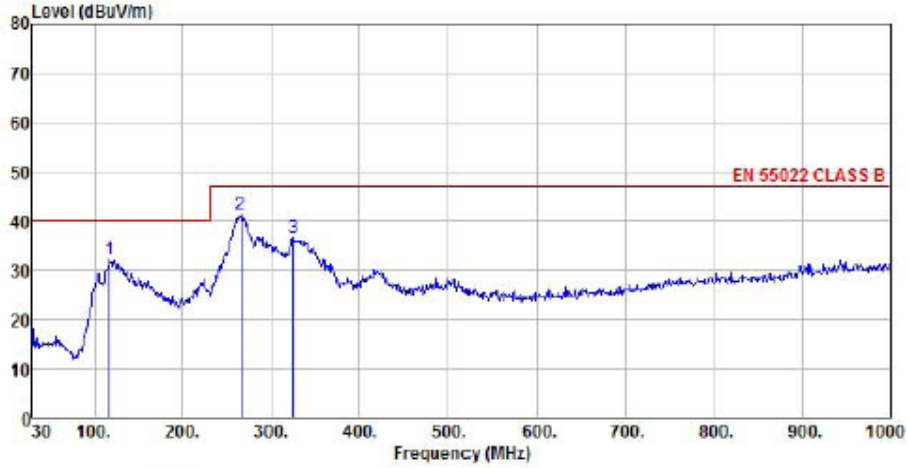

Site : chamber
 Condition : EN 55022 CLASS B 3m VULB9160 HORIZONTAL
 EUT :
 Model Name : case 22
 Temp/Humi : 22 °C / 51 %
 Power Rating: 5V 3.4A
 Mode :
 Memo :

	ReadAntenna	Cable	Preamp	Limit	Over			
	Level	Loss	Factor	Level	Line	Limit	Remark	
	dBuV	dB/m	dB	dB	dBuV/m	dBuV/m	dB	
1	117.30	18.88	11.84	1.44	0.00	32.16	40.00	-7.84 Peak
2 pp	265.71	26.93	12.33	2.20	0.00	41.46	47.00	-5.54 Peak
3	324.88	20.20	13.78	2.50	0.00	36.48	47.00	-10.52 Peak

Vbat=7.8V, Output: 5.07V/3.4A Vertical

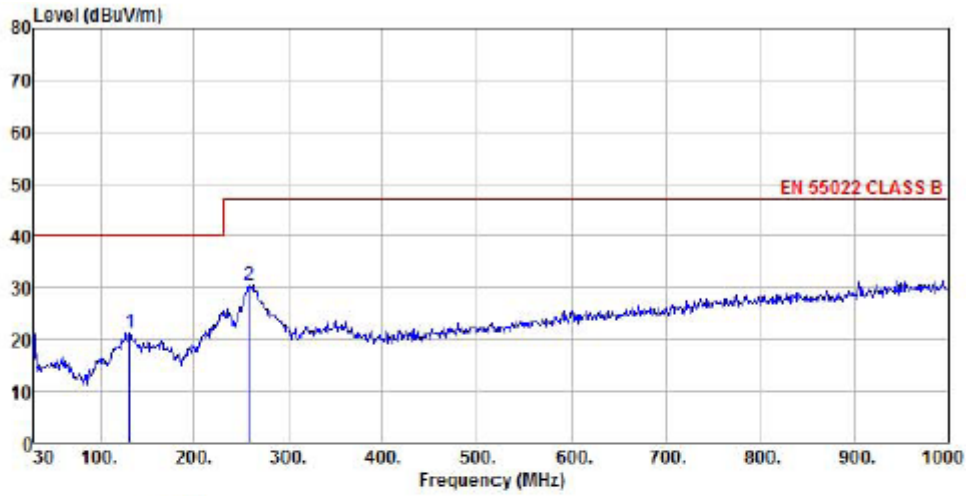

Site : chamber
 Condition : EN 55022 CLASS B 3m VULB9160 VERTICAL
 EUT :
 Model Name : case 14
 Temp/Humi : 22 °C / 51 %
 Power Rating: 5V 3.4A
 Mode :
 Memo :

	Freq	ReadAntenna Level	Antenna Factor	Cable Loss	Preamp Factor	Level	Limit Line	Over Limit	Remark
	MHz	dBuV	dB/m	dB	dB	dBuV/m	dBuV/m	dB	
1	131.85	6.87	12.78	1.61	0.00	21.26	40.00	-18.74	Peak
2 pp	258.92	16.26	12.09	2.18	0.00	30.53	47.00	-16.47	Peak