

ECH8697R

Power MOSFET for 1-2 Cells Lithium-ion Battery Protection 24 V, 11.6 mΩ, 10 A, Dual N-Channel



ON Semiconductor®

www.onsemi.com

This Power MOSFET features a low on-state resistance. This device is suitable for applications such as power switches of portable machines. Best suited for 1-2 cells Lithium-ion Battery applications.

Features

- Low On-Resistance
- 2.5 V drive
- Common-Drain Type
- ESD Diode-Protected Gate
- Built-in Gate Protection Resistor
- Pb-Free, Halogen Free and RoHS compliance

Typical Applications

- 1-2 cells Lithium-ion Battery Charging and Discharging Switch

SPECIFICATIONS

ABSOLUTE MAXIMUM RATING at Ta = 25°C (Note 1)

Parameter	Symbol	Value	Unit
Drain to Source Voltage	VDSS	24	V
Gate to Source Voltage	VGSS	±12.5	V
Drain Current (DC)	ID	10	A
Drain Current (Pulse) PW ≤ 10 μs, duty cycle ≤ 1%	IDP	60	A
Power Dissipation Surface mounted on ceramic substrate (1000 mm ² × 0.8 mm) 1 unit	PD	1.5	W
Total Dissipation Surface mounted on ceramic substrate (1000 mm ² × 0.8 mm)	PT	1.6	W
Junction Temperature	Tj	150	°C
Storage Temperature	Tstg	-55 to +150	°C

Note 1 : Stresses exceeding those listed in the Maximum Ratings table may damage the device. If any of these limits are exceeded, device functionality should not be assumed, damage may occur and reliability may be affected.

THERMAL RESISTANCE RATINGS

Parameter	Symbol	Value	Unit
Junction to Ambient Surface mounted on ceramic substrate (1000 mm ² × 0.8 mm) 1 unit	RθJA	83.3	°C/W

VDSS	RDS(on) Max	ID Max
24 V	11.6 mΩ @ 4.5 V	10 A
	12.6 mΩ @ 4.0 V	
	15 mΩ @ 3.1 V	
	17.5 mΩ @ 2.5 V	

ELECTRICAL CONNECTION N-Channel

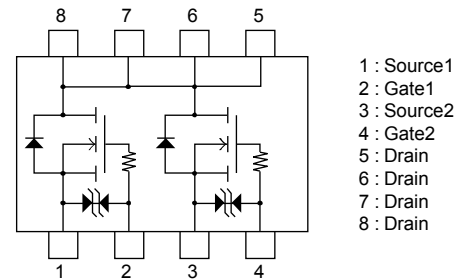

MARKING

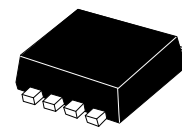

SOT-28FL / ECH8

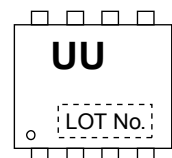

ORDERING INFORMATION

See detailed ordering and shipping information on page 5 of this data sheet.

ECH8697R

ELECTRICAL CHARACTERISTICS at Ta = 25°C (Note 2)

Parameter	Symbol	Conditions	Value			Unit
			min	typ	max	
Drain to Source Breakdown Voltage	V(BR)DSS	I _D = 1 mA, V _{GS} = 0 V	24			V
Zero-Gate Voltage Drain Current	I _{DSS}	V _{DS} = 20 V, V _{GS} = 0 V			1	μA
Gate to Source Leakage Current	I _{GSS}	V _{GS} = ±8 V, V _{DS} = 0 V			±1	μA
Gate Threshold Voltage	V _{GS(th)}	V _{DS} = 10 V, I _D = 1 mA	0.5		1.3	V
Forward Transconductance	g _{FS}	V _{DS} = 10 V, I _D = 5 A		5.0		S
Static Drain to Source On-State Resistance	R _{DS(on)}	I _D = 5 A, V _{GS} = 4.5 V	7.4	9.3	11.6	mΩ
		I _D = 5 A, V _{GS} = 4.0 V	7.7	9.7	12.6	mΩ
		I _D = 5 A, V _{GS} = 3.1 V	8.5	10.7	15	mΩ
		I _D = 2.5 A, V _{GS} = 2.5 V	10	12.5	17.5	mΩ
Turn-ON Delay Time	t _{d(on)}	See Fig. 1 (Note 3)		160		ns
Rise Time	t _r			230		ns
Turn-OFF Delay Time	t _{d(off)}			19.7		μs
Fall Time	t _f			23.6		μs
Turn-ON Delay Time	t _{d(on)}	See Fig. 2 (Note 3)		160		ns
Rise Time	t _r			230		ns
Turn-OFF Delay Time	t _{d(off)}			980		μs
Fall Time	t _f			350		μs
Total Gate Charge	Q _g	V _{DS} = 10 V, V _{GS} = 4.5 V, I _D = 10 A		6		nC
Gate to Source Charge	Q _{gs}			1.1		nC
Gate to Drain "Miller" Charge	Q _{gd}			0.9		nC
Forward Diode Voltage	V _{SD}	I _S = 10 A, V _{GS} = 0 V		0.8	1.2	V

Note 2 : Product parametric performance is indicated in the Electrical Characteristics for the listed test conditions, unless otherwise noted. Product performance may not be indicated by the Electrical Characteristics if operated under different conditions.

Note 3 : The fall switching time is dependent on the input pulse width.

Fig.1 Switching Time Test Circuit 1

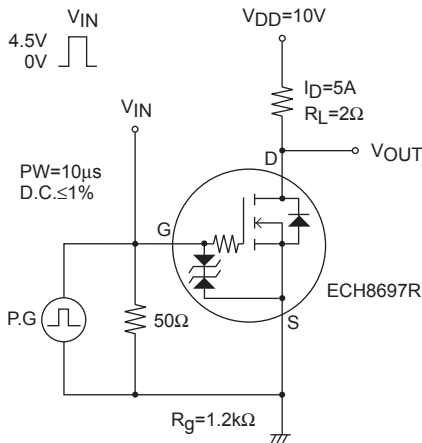
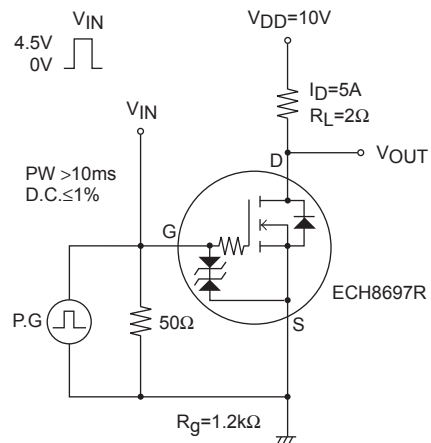
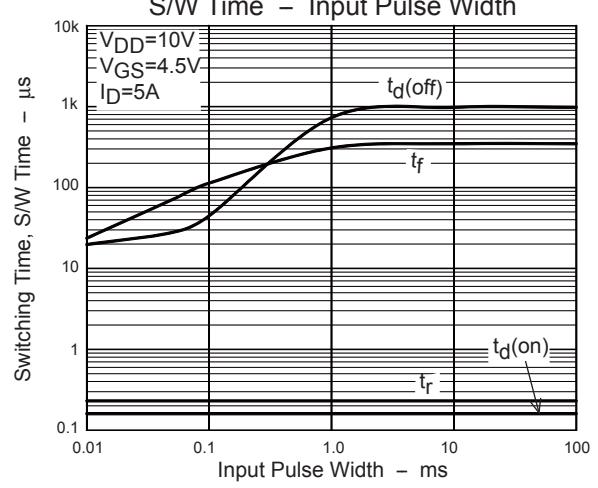
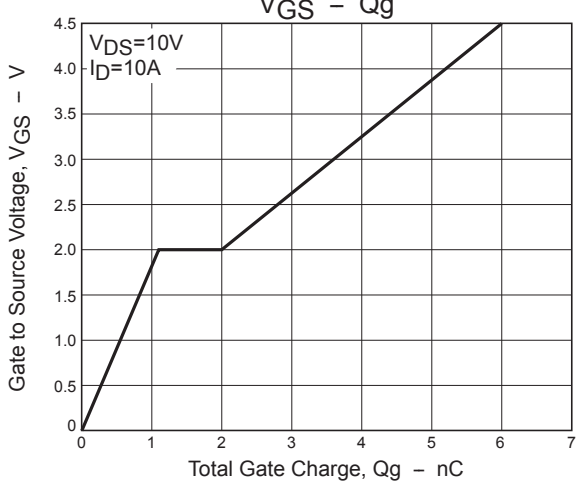
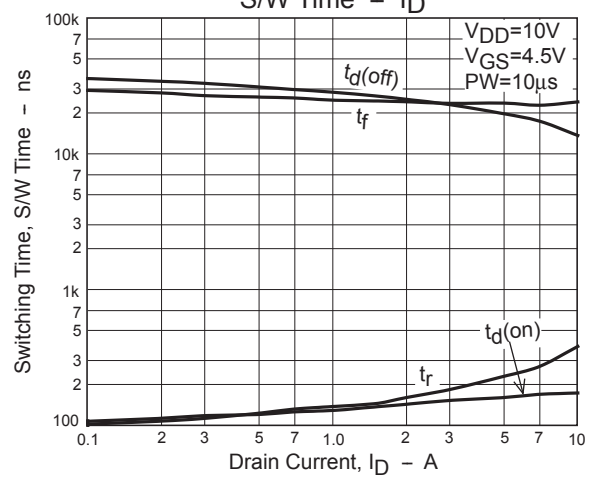
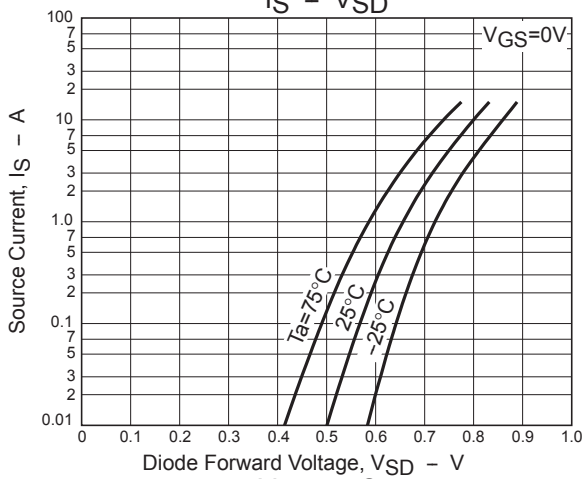
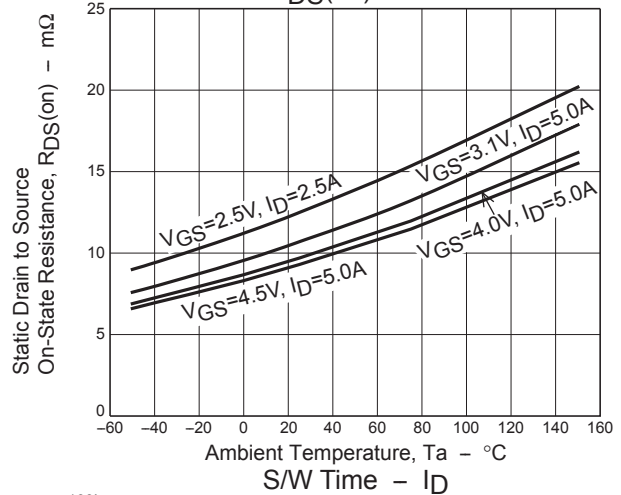
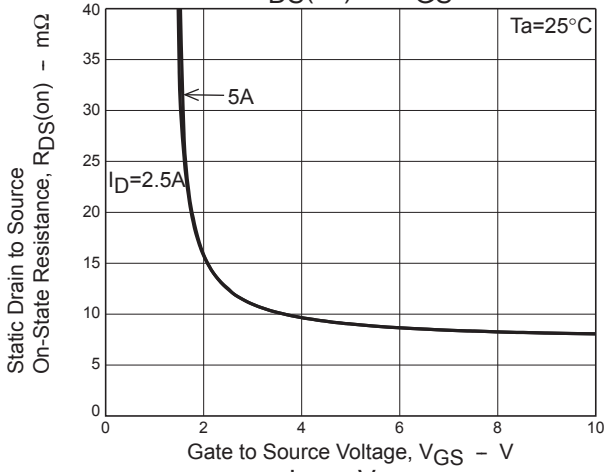
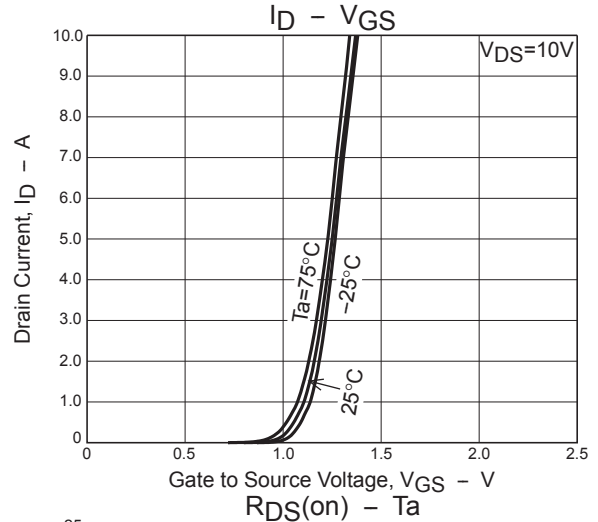
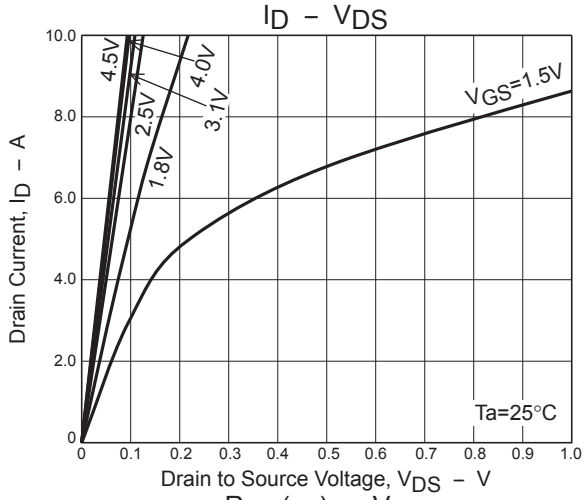

Fig.2 Switching Time Test Circuit 2



ECH8697R



ECH8697R

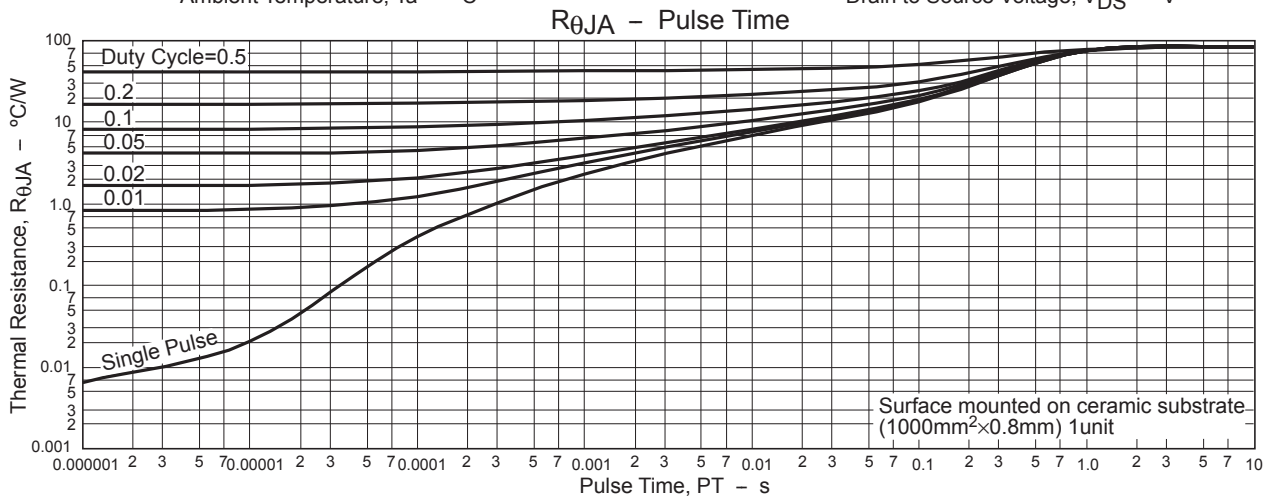
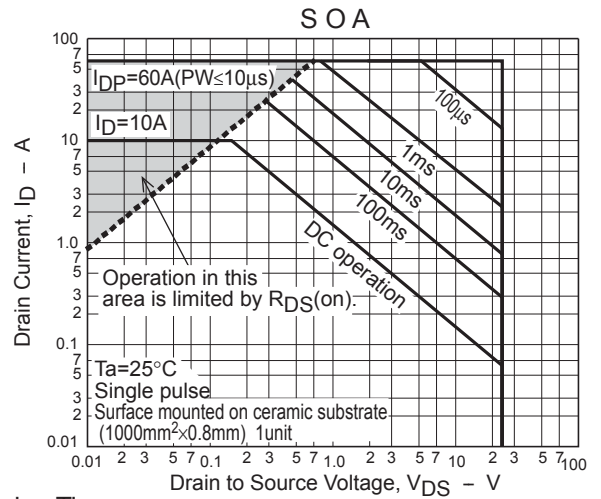
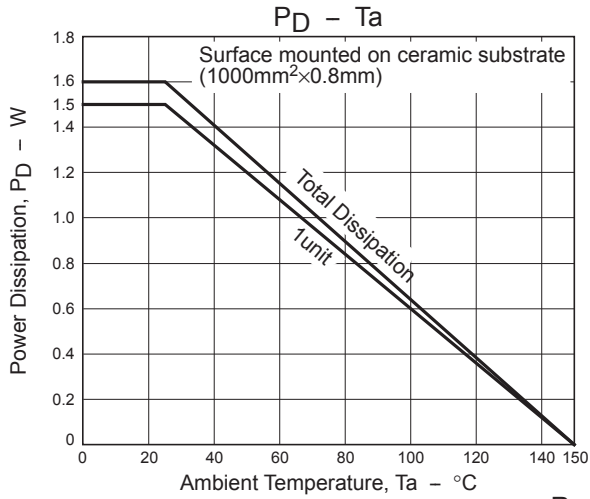

ECH8697R

PACKAGE DIMENSIONS

unit : mm

SOT-28FL / ECH8
CASE 318BF
ISSUE O

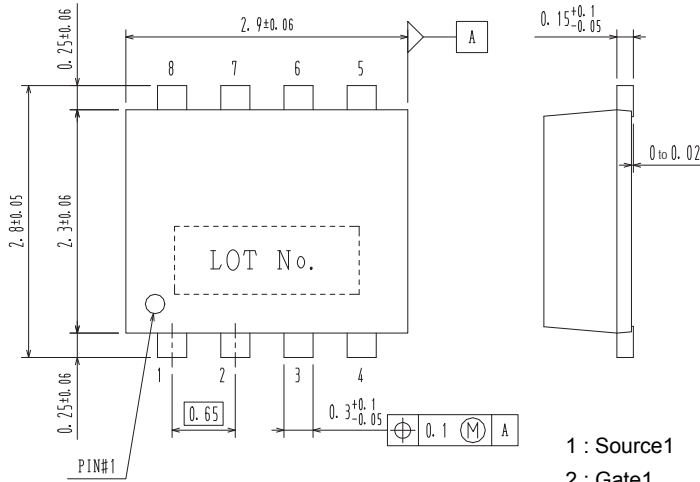

- 1 : Source1
- 2 : Gate1
- 3 : Source2
- 4 : Gate2
- 5 : Drain
- 6 : Drain
- 7 : Drain
- 8 : Drain

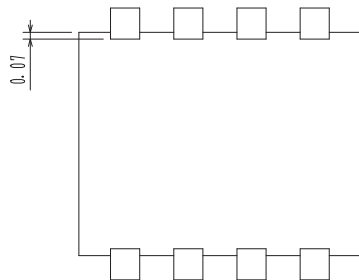
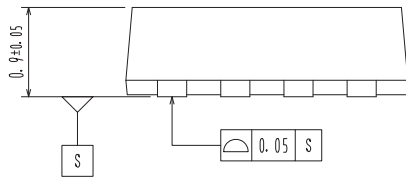

Recommended Soldering Footprint

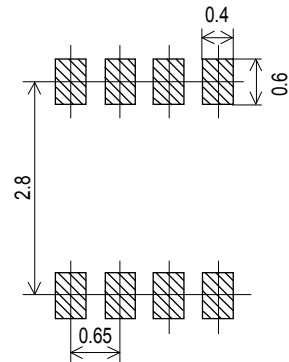

ORDERING INFORMATION

Device	Marking	Package	Shipping (Qty / Packing)
ECH8697R-TL-W	UU	SOT-28FL / ECH8 (Pb-Free / Halogen Free)	3,000 / Tape & Reel

† For information on tape and reel specifications, including part orientation and tape sizes, please refer to our Tape and Reel Packaging Specifications Brochure, BRD8011/D. http://www.onsemi.com/pub_link/Collateral/BRD8011-D.PDF

Note on usage : Since the ECH8697R is a MOSFET product, please avoid using this device in the vicinity of highly charged objects. Please contact sales for use except the designated application.

ON Semiconductor and the ON Semiconductor logo are trademarks of Semiconductor Components Industries, LLC dba ON Semiconductor or its subsidiaries in the United States and/or other countries. ON Semiconductor owns the rights to a number of patents, trademarks, copyrights, trade secrets, and other intellectual property. A listing of ON Semiconductor's product/patent coverage may be accessed at www.onsemi.com/site/pdf/Patent-Marking.pdf. ON Semiconductor reserves the right to make changes without further notice to any products herein. ON Semiconductor makes no warranty, representation or guarantee regarding the suitability of its products for any particular purpose, nor does ON Semiconductor assume any liability arising out of the application or use of any product or circuit, and specifically disclaims any and all liability, including without limitation special, consequential or incidental damages. Buyer is responsible for its products and applications using ON Semiconductor products, including compliance with all laws, regulations and safety requirements or standards, regardless of any support or applications information provided by ON Semiconductor. "Typical" parameters which may be provided in ON Semiconductor data sheets and/or specifications can and do vary in different applications and actual performance may vary over time. All operating parameters, including "Typicals" must be validated for each customer application by customer's technical experts. ON Semiconductor does not convey any license under its patent rights nor the rights of others. ON Semiconductor products are not designed, intended, or authorized for use as a critical component in life support systems or any FDA Class 3 medical devices or medical devices with a same or similar classification in a foreign jurisdiction or any devices intended for implantation in the human body. Should Buyer purchase or use ON Semiconductor products for any such unintended or unauthorized application, Buyer shall indemnify and hold ON Semiconductor and its officers, employees, subsidiaries, affiliates, and distributors harmless against all claims, costs, damages, and expenses, and reasonable attorney fees arising out of, directly or indirectly, any claim of personal injury or death associated with such unintended or unauthorized use, even if such claim alleges that ON Semiconductor was negligent regarding the design or manufacture of the part. ON Semiconductor is an Equal Opportunity/Affirmative Action Employer. This literature is subject to all applicable copyright laws and is not for resale in any manner.