

Ultra-minute Photoelectric Sensor

**EX-Z Series**

**USER'S MANUAL**

---

# Contents

|                                   |    |
|-----------------------------------|----|
| 1. Cautions .....                 | 3  |
| 2. Part Description .....         | 4  |
| 3. Mounting .....                 | 5  |
| 3-1 Mounting of sensor .....      | 5  |
| 3-2 Installation interval .....   | 7  |
| 4. I/O Circuit Diagram .....      | 9  |
| 5. Stability Indicator .....      | 10 |
| 6. Beam Alignment .....           | 11 |
| 7. Option .....                   | 12 |
| 7-1 Sensor mounting bracket ..... | 12 |
| 8. Specifications .....           | 13 |
| 8-1 Side sensing type .....       | 13 |
| 8-2 Front sensing type .....      | 14 |
| 9. Dimensions .....               | 15 |

# 1. Cautions

|  |
|--|
|  <b>WARNING</b> |
|--|

- |   |
|---|
| <ul style="list-style-type: none"><li>● Never use this product as a sensing device for personnel protection.</li><li>● When using sensing devices for personnel protection, use products that meet laws and standards, such as OSHA, ANSI or IEC etc., for personnel protection applicable in each region or country.</li></ul> |
|---|
- This product has been developed / produced for industrial use only.
  - This product employs a small cable of 0.1mm<sup>2</sup> in conductor area. Take care that the cable is not pulled with a strong force, as it may damage this product or break its wires.
  - Make sure that stress by forcible bend or pulling is not applied to the sensor cable joint.
  - Cable can be extended up to 50m in total length (each emitter / receiver of thru-beam type) if extension cable is more than 0.3mm<sup>2</sup> in electric conductor cross-sectional area.
  - Make sure that the power supply is OFF while adding or removing the controllers.
  - Take note that incorrect wiring will damage the sensor.
  - Verify that the supply voltage variation is within the rating.
  - If power is supplied from a commercial switching regulator, ensure that the frame ground (F.G.) terminal of the power supply is connected to an actual ground.
  - When noise generating equipment (switching regulator, inverter motor, etc.) is used in the vicinity of this product, connect the frame ground (F.G.) terminal of the equipment to an actual ground.
  - Do not run the wires together with high-voltage lines or power lines or put them in the same raceway. This can cause malfunction due to induction.
  - Take care that the sensor is not directly exposed to fluorescent lamp from a rapid-starter lamp, a high frequency lighting device or sunlight etc., as it may affect the sensing performance.
  - Do not use during the initial transient time (50ms) after the power supply is switched ON.
  - This product is suitable for indoor use only.
  - Avoid dust, dirt, and steam.
  - Do not use this sensor in places where it may come in contact with corrosive gas, etc.
  - Ensure that the product does not come into contact with organic solvents such as thinner.
  - Ensure that the product does not come into contact with strong acid or alkaline.
  - Ensure that the product does not come into contact with oil or grease.
  - This product cannot be used in an environment containing inflammable or explosive gases.
  - Never disassemble or modify the product.
  - Cable end has not been waterproofed. Do not use the product in any manner that may cause water entry via cable end.

## 2. Part Description

### Thru-beam emitter side sensing type EX-Z11□, EX-Z12□, EX-Z13□

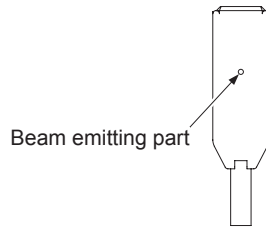

### Thru-beam receiver side sensing type EX-Z11□, EX-Z12□, EX-Z13□

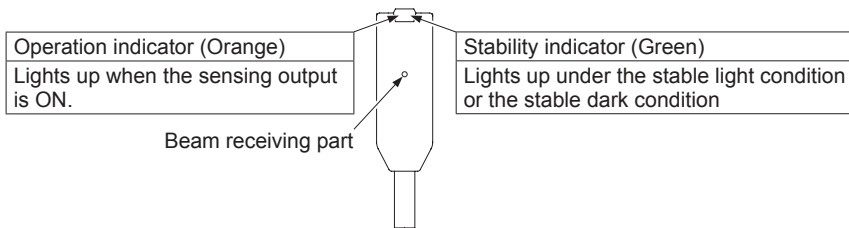

### Thru-beam emitter front sensing type EX-Z11F□, EX-Z12F□, EX-Z13F□

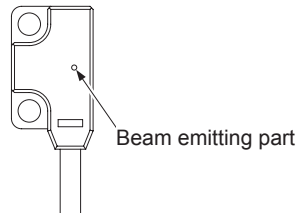

### Thru-beam receiver front sensing type EX-Z11F□, EX-Z12F□, EX-Z13F□

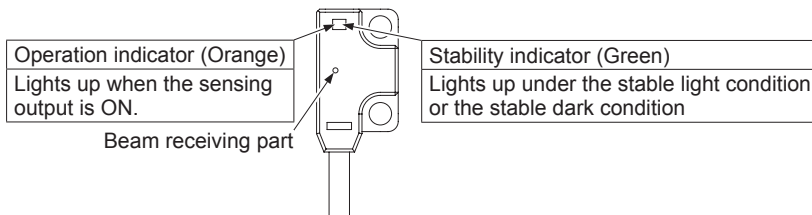

# 3. Mounting

## 3-1 Mounting of sensor

- The tightening torque should be 0.2N·m or less.
- M2 screw and nut, spring washer, and flat washer are accessory of this product.

### When tapping in mounting section (Unit: mm)

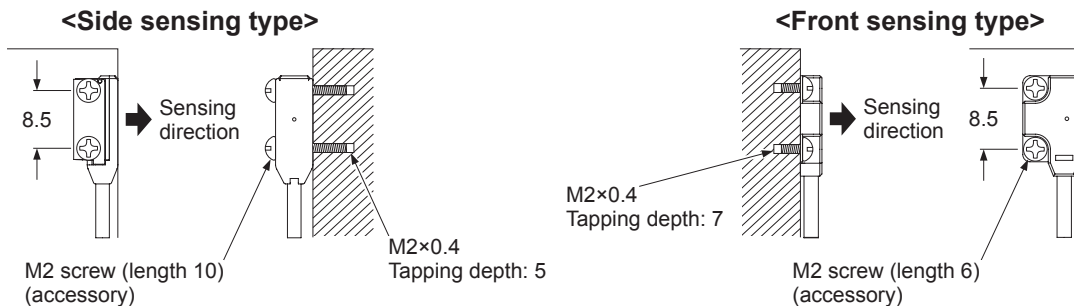

### When using screws and nuts that are accessory of the product (Unit: mm)

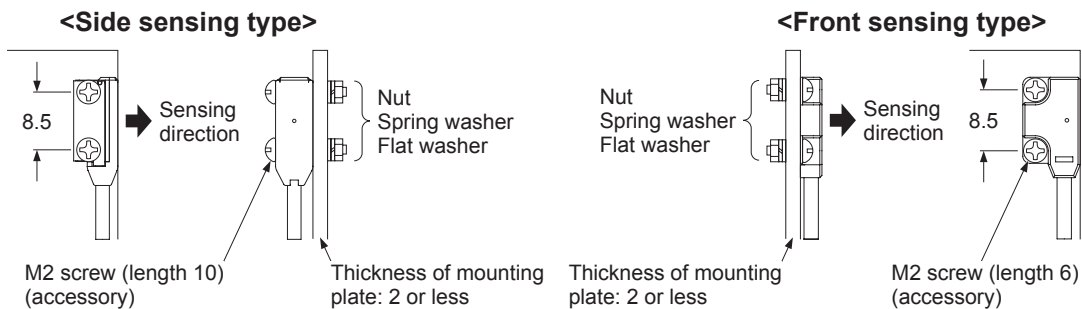

**When using sensor mounting bracket (optional)**

**〈L-shaped mounting bracket〉  
MS-EXZ-1**

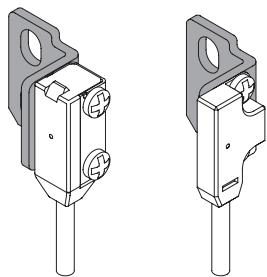

**〈Mounting bracket for front sensing type〉  
MS-EXZ-2**

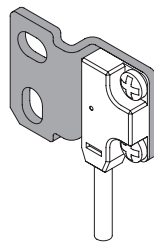

**〈Mounting bracket for side sensing type〉  
MS-EXZ-3**

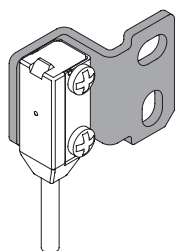

**〈Mounting spacer for front sensing type〉  
MS-EXZ-4**

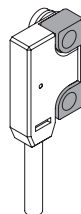

## 3-2 Installation interval

- Interference prevention function is not incorporated in this product. In case mounting two sets of this product close together, please mount it as drawing below indicates. (Typical example)
- Find out the operating point  $\ell_1$  on the parallel deviation diagram for the sensing distance L1. Separate sensors by  $2 \times \ell_1$  or more.

**EX-Z11□, EX-Z11F□**

### <Parallel deviation diagram (typical)>

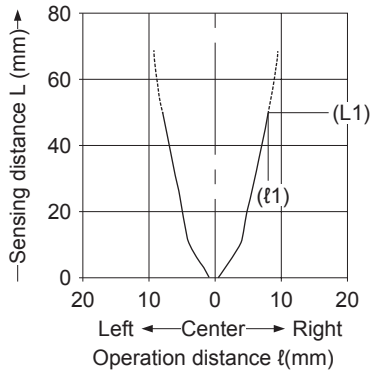

In case using at sensing distance (L1) 50mm, the operation point ( $\ell_1$ ) is approx. 8.02mm according to diagram above.

The installation interval is

Approx.  $8.02\text{mm} \times 2 = \text{approx. } 16.04\text{mm}$

Thus, install the product to approx. 16.04mm or more away.

### <Installation interval>

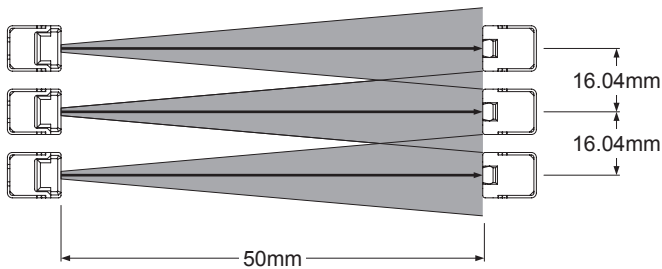

**EX-Z12□, EX-Z12F□**

**<Parallel deviation diagram (typical)>**

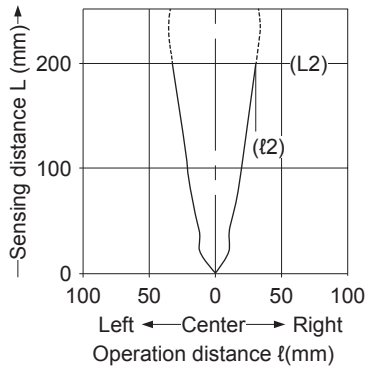

In case using at sensing distance (L2) 200mm, the operation point (ℓ2) is approx. 30.5mm according to the diagram at left.

The installation interval is

Approx. 30.5mm X 2 = approx. 61mm

Thus, install the product to approx. 61mm or more away.

**<Installation interval>**

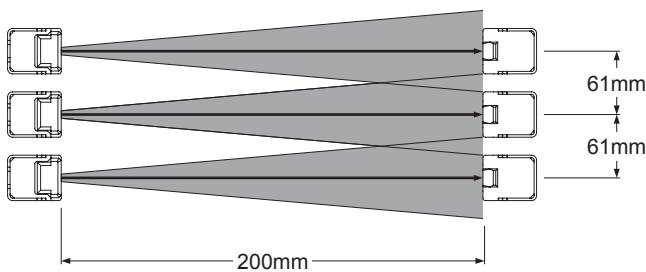

**EX-Z13□, EX-Z13F□**

**<Parallel deviation diagram (typical)>**

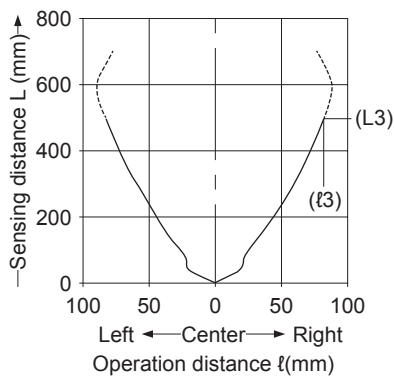

In case using at sensing distance (L3) 500mm, the operation point (ℓ3) is approx. 81.9mm according to the diagram at left.

The installation interval is

Approx. 81.9mm X 2 = approx. 163.8mm

Thus, install the product to approx. 163.8mm or more away.

**<Installation interval>**

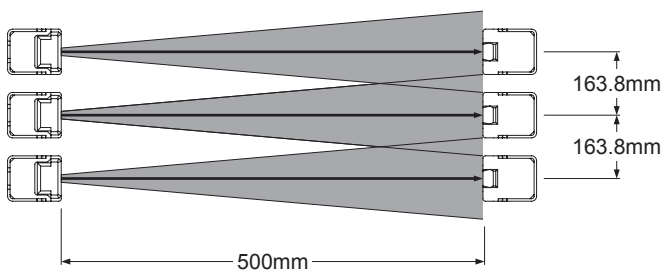



# 4. I/O Circuit Diagram

## NPN output type and PNP output type common: Thru-beam type emitter EX-Z1□

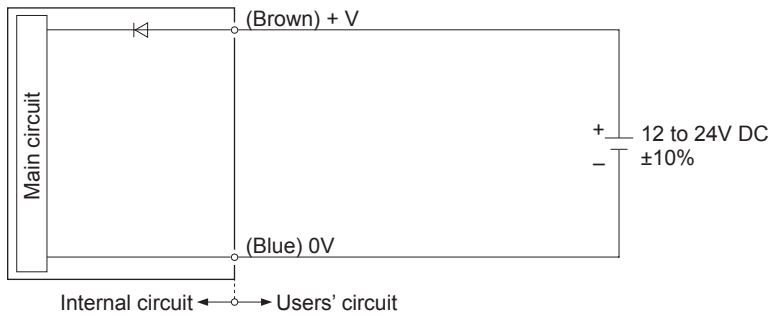

## NPN output type: Thru-beam type receiver EX-Z1□

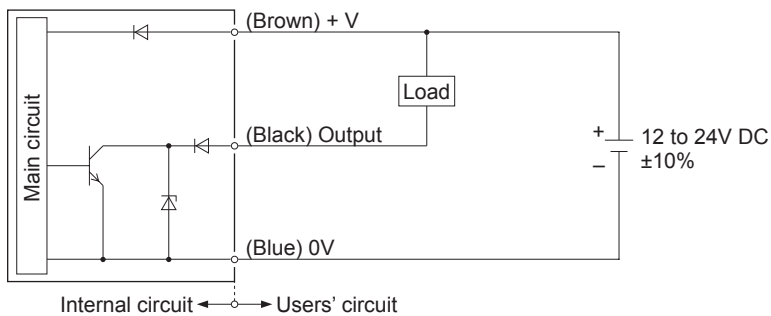

## PNP output type: Thru-beam type receiver EX-Z1□-P

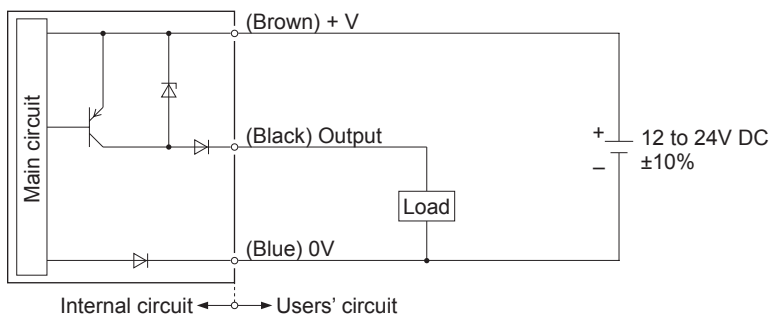

# 5. Stability Indicator

- The stability indicator (green) lights up when the incident light intensity has sufficient margin to the operation level.

When the beam is received at a level where the stability indicator lights up, stable sensing is possible in both the "Light" state operation and the "Dark" state operation without being affected by changes in temperature, voltage, etc.

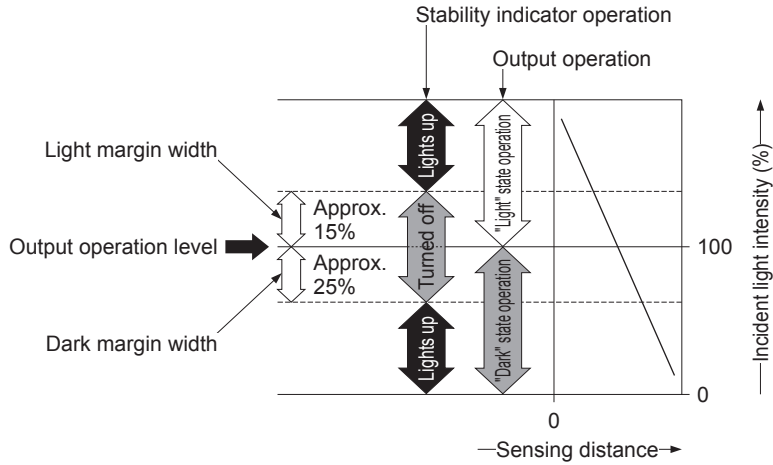

# 6. Beam Alignment

1. Place the emitter and the receiver face to face along a straight line. Move the emitter in the up, down, left and right directions, in order to determine the range of the light received condition with the help of the operation indicator (orange), and place it almost at the center.
2. Similarly, adjust for up, down, left and right angular movement of the emitter.
3. Further, perform the angular adjustment for the receiver also.
4. Check that the stability indicator (green) lights up.

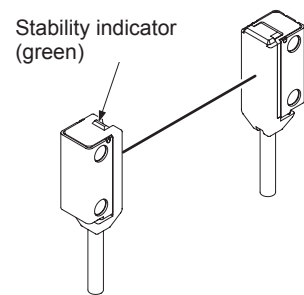
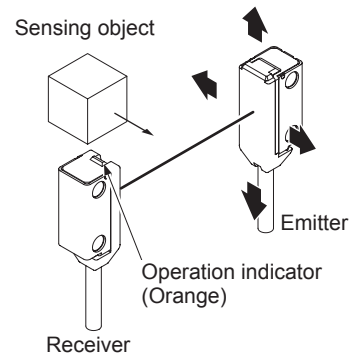

# 7. Option

## 7-1 Sensor mounting bracket

| Product name                    | Model No.       | Description  |
|---------------------------------|-----------------|--|
| Sensor mounting bracket         | <b>MS-EXZ-1</b> | Mounting bracket common to side sensing type and front sensing type (2 sets required)<br>Material: Stainless steel (SUS304)<br>M2 (length 4mm) screw: 2 screws, M2 (length 8mm) screw: 2 screws are attached |
|                                 | <b>MS-EXZ-2</b> | Mounting bracket for front sensing type (2 sets required)<br>Material: Stainless steel (SUS304)<br>M2 (length 4mm) screw: 2 screws attached  |
|                                 | <b>MS-EXZ-3</b> | Mounting bracket for side sensing type (2 sets required)<br>Material: Stainless steel (SUS304)<br>M2 (length 8mm) screw: 2 screws attached   |
| Spacer for mounting at the back | <b>MS-EXZ-4</b> | Mounting bracket for front sensing type (10 pieces / set)<br>Material: POM<br>M2 (length 10mm) screw, nut, spring washer, flat washer: 20 pieces are attached to each  |

<MS-EXZ-1>

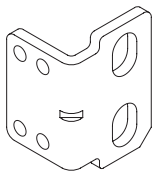

<MS-EXZ-2>

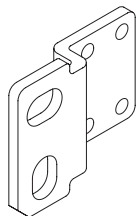

<MS-EXZ-3>

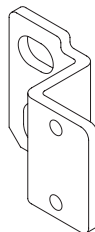

<MS-EXZ-4>



# 8. Specifications

## 8-1 Side sensing type

| Type   |                          | Sensing distance 50mm type   |                  | Sensing distance 200mm type  |  | Sensing distance 500mm type  |                  |
|--|--------------------------|--|------------------|--|--|--|------------------|
|  |                          | Light-ON   | Dark-ON          | Light-ON   | Dark-ON  | Light-ON   | Dark-ON          |
| Model No.<br>(note 2)                            | NPN output               | <b>EX-Z11A</b>   | <b>EX-Z11B</b>   | <b>EX-Z12A</b>   | <b>EX-Z12B</b>   | <b>EX-Z13A</b>   | <b>EX-Z13B</b>   |
|  | PNP output               | <b>EX-Z11A-P</b>   | <b>EX-Z11B-P</b> | <b>EX-Z12A-P</b>   | <b>EX-Z12B-P</b>   | <b>EX-Z13A-P</b>   | <b>EX-Z13B-P</b> |
| Sensing distance                                 |                          | 50mm   |                  | 200mm  |  | 500mm  |                  |
| Minimum sensing object                           |                          | ø0.3mm opaque object (Completely beam interrupted object) (Setting distance between emitter and receiver: 50mm)  |                  | ø0.5mm opaque object (Completely beam interrupted object) (Setting distance between emitter and receiver: 200mm) |  | ø1.0mm opaque object (Completely beam interrupted object) (Setting distance between emitter and receiver: 500mm) |                  |
| Repeatability<br>(Perpendicular to sensing axis) |                          | 0.02mm or less   |                  | 0.03mm or less   |  | 0.05mm or less   |                  |
| Supply voltage                                   |                          | 12 to 24V DC ±10% Ripple P-P 10% or less   |                  |  |  |  |                  |
| Current consumption                              |                          | Emitter: 10mA or less, Receiver: 10mA or less  |                  |  |  |  |                  |
| Output   |                          | <NPN output type><br>NPN open-collector transistor   |                  |  | <PNP output type><br>PNP open-collector transistor   |  |                  |
|  |                          | <ul style="list-style-type: none"> <li>• Maximum sink current: 20mA</li> <li>• Applied voltage: 30V DC or less<br/>(between output and 0V)</li> <li>• Residual voltage: 1.5V or less<br/>(at 20mA sink current)</li> </ul> |                  |  | <ul style="list-style-type: none"> <li>• Maximum source current: 20mA</li> <li>• Applied voltage: 30V DC or less<br/>(between output and +V)</li> <li>• Residual voltage: 1.5V or less<br/>(at 20mA source current)</li> </ul> |  |                  |
| Short-circuit protection                         |                          | Incorporated   |                  |  |  |  |                  |
| Response time                                    |                          | 0.5ms or less  |                  |  |  |  |                  |
| Protection                                       |                          | IP67 (IEC)   |                  |  |  |  |                  |
| Environment resistance                           | Ambient temperature      | -10 to +55°C (No dew condensation or icing allowed), Storage: -30 to +70°C   |                  |  |  |  |                  |
|  | Ambient humidity         | 35 to 85% RH, Storage: 35 to 85% RH  |                  |  |  |  |                  |
|  | Ambient illuminance      | Incandescent light: 5,000lx at the light-receiving face  |                  |  |  |  |                  |
|  | Voltage withstandability | 1,000V AC for one min. between all supply terminals connected together and enclosure   |                  |  |  |  |                  |
|  | Insulation resistance    | 20MΩ, or more, with 250V DC megger between all supply terminals connected together and enclosure   |                  |  |  |  |                  |
|  | Vibration resistance     | 10 to 500Hz frequency, 3mm amplitude (20G max.) in X, Y and Z directions for two hours each  |                  |  |  |  |                  |
|  | Shock resistance         | 500m/s <sup>2</sup> acceleration (50G approx.) in X, Y and Z directions for three times each   |                  |  |  |  |                  |
| Emitting element                                 |                          | Red LED (Peak emission wavelength: 650nm)  |                  |  |  |  |                  |
| Material   |                          | Enclosure: PBT, Lens: Polycarbonate, Metallic part: Stainless steel (SUS304)   |                  |  |  |  |                  |
| Cable (Note 3)                                   |                          | 0.1mm <sup>2</sup> 3-core (emitter: 2-core) cabtyre cable, 2m long   |                  |  |  |  |                  |
| Cable extension                                  |                          | Extension up to total 50m is possible with 0.3mm <sup>2</sup> , or more, cable (thru-beam type: emitter and receiver).   |                  |  |  |  |                  |
| Weight (Main body only)                          |                          | Each of emitter and receiver: Approx. 15g  |                  |  |  |  |                  |
| Accessories                                      |                          | M2 screw (length 10mm): 2 pcs., Nut: 2 pcs., Spring washer: 2 pcs., Flat washer: 2 pcs. Instruction manual: 1 pc.  |                  |  |  |  |                  |

Notes: 1) Where measurement conditions have not been specified precisely, the conditions used were an ambient temperature of +23 °C.

2) The model No. with suffix "E" shown on the label affixed to the thru-beam type sensor is the emitter, "D" shown on the label is the receiver.

(Example) Emitter of **EX-Z11A**: **EX-Z11E**, Receiver of **EX-Z11A**: **EX-Z11AD**

Model Nos. having suffix "-R" are inflection resistant cable type.

(Example) The inflection resistant cable type of **EX-Z11A-P** is "**EX-Z11A-P-R**".

3) The inflection resistant cable type (model having "-R" at its end of the model No.) is 0.1mm<sup>2</sup> 3-core (emitter: 2-core) cabtyre cable, which is 2m long.

## 8-2 Front sensing type

| Type   |  | Sensing distance 50mm type   |                   | Sensing distance 200mm type  |  | Sensing distance 500mm type  |                   |
|--|--|--|-------------------|--|--|--|-------------------|
|  |  | Light-ON   | Dark-ON           | Light-ON   | Dark-ON  | Light-ON   | Dark-ON           |
| Model No.<br>(Note 2)                            | NPN output   | <b>EX-Z11FA</b>  | <b>EX-Z11FB</b>   | <b>EX-Z12FA</b>  | <b>EX-Z12FB</b>  | <b>EX-Z13FA</b>  | <b>EX-Z13FB</b>   |
|  | PNP output   | <b>EX-Z11FA-P</b>  | <b>EX-Z11FB-P</b> | <b>EX-Z12FA-P</b>  | <b>EX-Z12FB-P</b>  | <b>EX-Z13FA-P</b>  | <b>EX-Z13FB-P</b> |
| Sensing distance                                 |  | 50mm   |                   | 200mm  |  | 500mm  |                   |
| Minimum sensing object                           |  | ø0.3mm opaque object (Completely beam interrupted object) (Setting distance between emitter and receiver: 50mm)  |                   | ø0.5mm opaque object (Completely beam interrupted object) (Setting distance between emitter and receiver: 200mm) |  | ø1.0mm opaque object (Completely beam interrupted object) (Setting distance between emitter and receiver: 500mm) |                   |
| Repeatability<br>(Perpendicular to sensing axis) |  | 0.02mm or less   |                   | 0.03mm or less   |  | 0.05mm or less   |                   |
| Supply voltage                                   |  | 12 to 24V DC ±10% Ripple P-P 10% or less   |                   |  |  |  |                   |
| Current consumption                              |  | Emitter: 10mA or less, Receiver: 10mA or less  |                   |  |  |  |                   |
| Output   |  | <NPN output type><br>NPN open-collector transistor<br>• Maximum sink current: 20mA<br>• Applied voltage: 30V DC or less<br>(between output and 0V)<br>• Residual voltage: 1.5V or less<br>(at 20mA sink current) |                   |  | <PNP output type><br>PNP open-collector transistor<br>• Maximum source current: 20mA<br>• Applied voltage: 30V DC or less<br>(between output and +V)<br>• Residual voltage: 1.5V or less<br>(at 20mA source current) |  |                   |
|  |  | Short-circuit protection   |                   | Incorporated   |  |  |                   |
| Response time                                    |  | 0.5ms or less  |                   |  |  |  |                   |
| Environment resistance                           | Protection   | IP67 (IEC)   |                   |  |  |  |                   |
|  | Ambient temperature  | -10 to +55°C (No dew condensation or icing allowed), Storage: -30 to +70°C   |                   |  |  |  |                   |
|  | Ambient humidity   | 35 to 85% RH, Storage: 35 to 85% RH  |                   |  |  |  |                   |
|  | Ambient illuminance  | Incandescent light: 5,000lx at the light-receiving face  |                   |  |  |  |                   |
|  | Voltage withstandability   | 1,000V AC for one min. between all supply terminals connected together and enclosure   |                   |  |  |  |                   |
|  | Insulation resistance  | 20MΩ, or more, with 250V DC megger between all supply terminals connected together and enclosure   |                   |  |  |  |                   |
|  | Vibration resistance   | 10 to 500Hz frequency, 3mm amplitude (20G max.) in X, Y and Z directions for two hours each  |                   |  |  |  |                   |
| Shock resistance                                 | 500m/s <sup>2</sup> acceleration (50G approx.) in X, Y and Z directions for three times each |  |                   |  |  |  |                   |
| Emitting element                                 |  | Red LED (Peak emission wavelength: 650nm)  |                   |  |  |  |                   |
| Material   |  | Enclosure: PBT, Lens: Polycarbonate, Metallic part: Stainless steel (SUS304, Rear part: SUS301)  |                   |  |  |  |                   |
| Cable (Note 3)                                   |  | 0.1mm <sup>2</sup> 3-core (emitter: 2-core) cabtyre cable, 2m long   |                   |  |  |  |                   |
| Cable extension                                  |  | Extension up to total 50m is possible with 0.3mm <sup>2</sup> , or more, cable (thru-beam type: emitter and receiver).   |                   |  |  |  |                   |
| Weight (Main body only)                          |  | Each of emitter and receiver: Approx. 15g  |                   |  |  |  |                   |
| Accessories                                      |  | M2 screw (length 6mm): 2 pcs., Nut: 2 pcs., Spring washer: 2 pcs., Flat washer: 2 pcs.<br>Instruction manual: 1 pc.  |                   |  |  |  |                   |

Notes: 1) Where measurement conditions have not been specified precisely, the conditions used were an ambient temperature of +23 °C.

2) The model No. with suffix "E" shown on the label affixed to the thru-beam type sensor is the emitter, "D" shown on the label is the receiver.

(Example) Emitter of **EX-Z11FA**: **EX-Z11FE**, Receiver of **EX-Z11FA**: **EX-Z11FAD**

Model Nos. having suffix "-R" are inflection resistant cable type.

(Example) The inflection resistant cable type of **EX-Z11FA-P** is "**EX-Z11FA-P-R**".

3) The inflection resistant cable type (model having "-R" at its end of the model No.) is 0.1mm<sup>2</sup> 3-core (emitter: 2-core) cabtyre cable, which is 2m long.

# 9. Dimensions

## Thru-beam type side sensing type EX-Z11□, EX-Z12□, EX-Z13□

(Unit: mm)

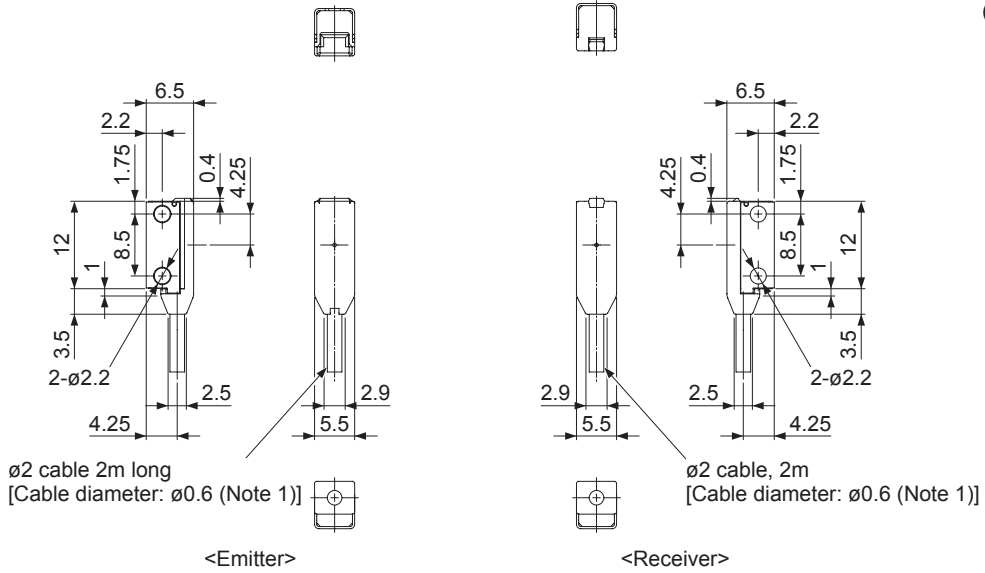

Note: The cable diameter of inflection resistant cable type is  $\phi 0.7$ mm.

## Thru-beam type front sensing type EX-Z11F□, EX-Z12F□, EX-Z13F□

(Unit: mm)

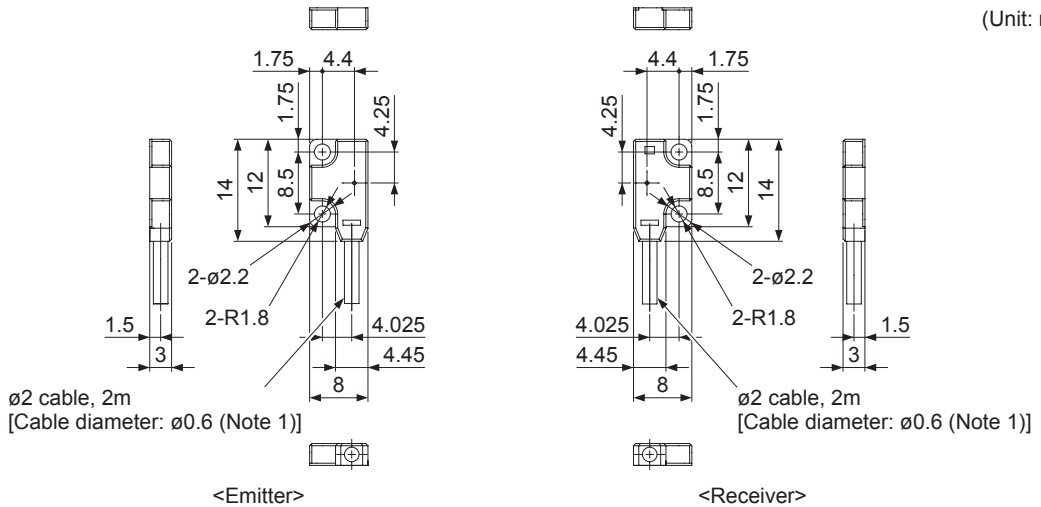

Note: The cable diameter of inflection resistant cable type is  $\phi 0.7$ mm.

**Sensor mounting bracket MS-EXZ-1**

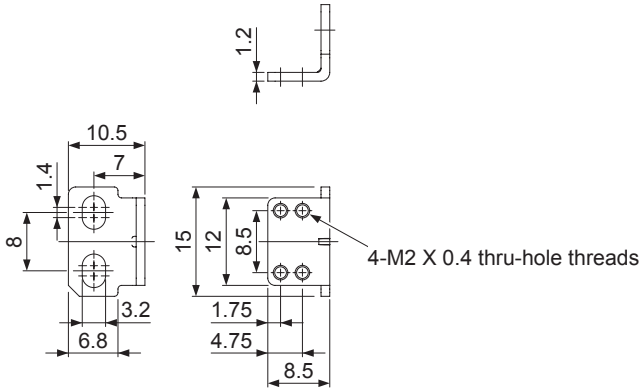

(Unit: mm)

**Sensor mounting bracket MS-EXZ-2**

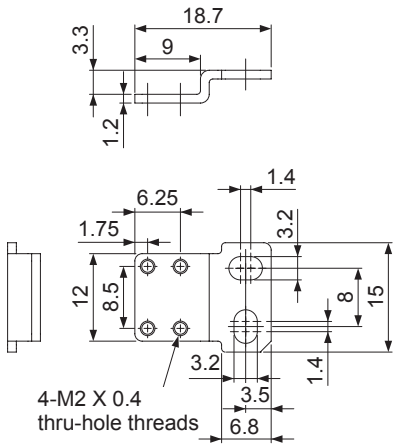

(Unit: mm)

**Sensor mounting bracket MS-EXZ-3**

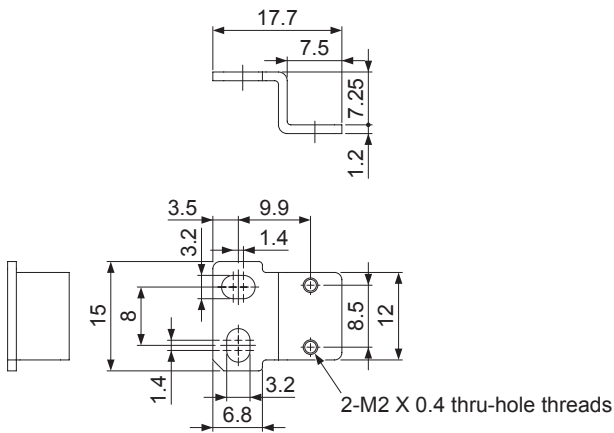

(Unit: mm)



**Spacer for mounting at the back MS-EXZ-4**

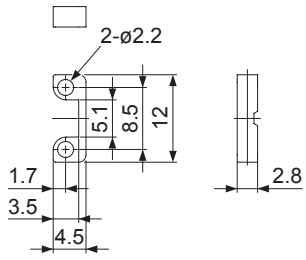

(Unit: mm)

---

Please contact .....

## **Panasonic Industrial Devices SUNX Co., Ltd.**

■ Overseas Sales Division (Head Office): 2431-1 Ushiyama-cho, Kasugai-shi, Aichi, 486-0901, Japan  
■ Telephone: +81-568-33-7861 ■ Facsimile: +81-568-33-8591

[panasonic.net/id/pidsx/global](http://panasonic.net/id/pidsx/global)

For sales network, please visit our website.