

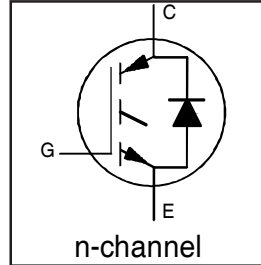
**INSULATED GATE BIPOLAR TRANSISTOR WITH  
 ULTRAFAST SOFT RECOVERY DIODE**

**Features**

- Low VCE (on) Non Punch Through IGBT Technology.
- Low Diode VF.
- 10µs Short Circuit Capability.
- Square RBSOA.
- Ultrasoft Diode Reverse Recovery Characteristics.
- Positive VCE (on) Temperature Coefficient.
- Maximum Junction Temperature Rated at 175°C
- Lead-Free
- UL Certified

**Benefits**

- Benchmark Efficiency for Motor Control.
- Rugged Transient Performance.
- Low EMI.
- Excellent Current Sharing in Parallel Operation.



$V_{CES} = 600V$   
 $I_C = 10A, T_C = 100^\circ C$   
 $t_{sc} > 10\mu s, T_J = 150^\circ C$   
 $V_{CE(on)} \text{ typ.} = 1.7V$



TO-220 Full-Pak

Base part number	Package Type	Standard Pack		Orderable Part Number
		Form	Quantity	
IRGIB10B60KD1P	TO-220AB Full- Pak	Tube	50	IRGIB10B60KD1P

**Absolute Maximum Ratings**

	Parameter	Max.	Units
$V_{CES}$	Collector-to-Emitter Voltage	600	V
$I_C @ T_C = 25^\circ C$	Continuous Collector Current	16	A
$I_C @ T_C = 100^\circ C$	Continuous Collector Current	10	
$I_{CM}$	Pulse Collector Current (Ref.Fig.C.T.5)	32	
$I_{LM}$	Clamped Inductive Load current ①	32	
$I_F @ T_C = 25^\circ C$	Diode Continuous Forward Current	16	
$I_F @ T_C = 100^\circ C$	Diode Continuous Forward Current	10	
$I_{FM}$	Diode Maximum Forward Current	32	
$V_{ISOL}$	RMS Isolation Voltage, Terminal to Case, $t = 1 \text{ min}$	2500	V
$V_{GE}$	Gate-to-Emitter Voltage	$\pm 20$	
$P_D @ T_C = 25^\circ C$	Maximum Power Dissipation	44	W
$P_D @ T_C = 100^\circ C$	Maximum Power Dissipation	22	
$T_J$	Operating Junction and	-55 to +175	°C
$T_{STG}$	Storage Temperature Range		
	Soldering Temperature for 10 sec.	300 (0.063 in. (1.6mm) from case)	
	Mounting Torque, 6-32 or M3 Screw	10 lbf.in (1.1N.m)	

**Thermal / Mechanical Characteristics**

	Parameter	Min.	Typ.	Max.	Units
$R_{\theta JC}$	Junction-to-Case- IGBT	—	—	3.4	°C/W
$R_{\theta JC}$	Junction-to-Case- Diode	—	—	5.3	
$R_{\theta CS}$	Case-to-Sink, flat, greased surface	—	0.50	—	
$R_{\theta JA}$	Junction-to-Ambient, typical socket mount	—	—	62	
Wt	Weight	—	2.0	—	g

**Electrical Characteristics @ T<sub>J</sub> = 25°C (unless otherwise specified)**

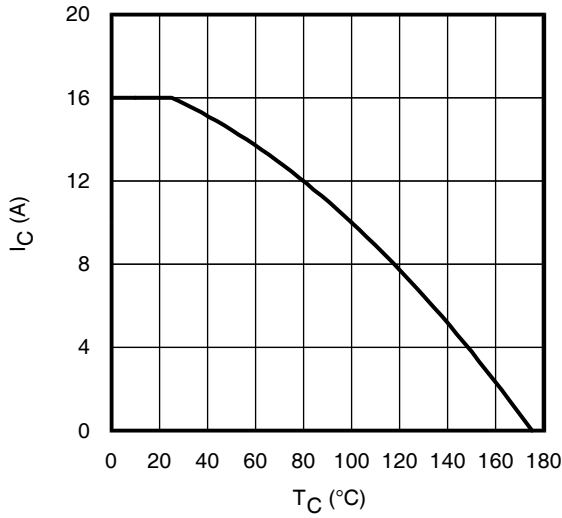
	Parameter	Min.	Typ.	Max.	Units	Conditions
V <sub>(BR)CES</sub>	Collector-to-Emitter Breakdown Voltage	600	—	—	V	V <sub>GE</sub> = 0V, I <sub>C</sub> = 500μA
ΔV <sub>(BR)CES</sub> /ΔT <sub>J</sub>	Temperature Coeff. of Breakdown Voltage	—	0.99	—	V/°C	V <sub>GE</sub> = 0V, I <sub>C</sub> = 1mA (25°C-150°C)
V <sub>CE(on)</sub>	Collector-to-Emitter Voltage	1.50	1.70	2.10	V	I <sub>C</sub> = 10A, V <sub>GE</sub> = 15V, T <sub>J</sub> = 25°C
		—	2.05	2.35		I <sub>C</sub> = 10A, V <sub>GE</sub> = 15V, T <sub>J</sub> = 150°C
		—	2.06	2.35		I <sub>C</sub> = 10A, V <sub>GE</sub> = 15V, T <sub>J</sub> = 175°C
V <sub>GE(th)</sub>	Gate Threshold Voltage	3.5	4.5	5.5	V	V <sub>CE</sub> = V <sub>GE</sub> , I <sub>C</sub> = 250μA
ΔV <sub>GE(th)</sub> /ΔT <sub>J</sub>	Threshold Voltage temp. coefficient	—	-10	—	mV/°C	V <sub>CE</sub> = V <sub>GE</sub> , I <sub>C</sub> = 1mA (25°C-150°C)
g <sub>f</sub>	Forward Transconductance	—	5.0	—	S	V <sub>CE</sub> = 50V, I <sub>C</sub> = 10A, PW = 80μs
I <sub>CES</sub>	Zero Gate Voltage Collector Current	—	1.0	150	μA	V <sub>GE</sub> = 0V, V <sub>CE</sub> = 600V
		—	90	250		V <sub>GE</sub> = 0V, V <sub>CE</sub> = 600V, T <sub>J</sub> = 150°C
		—	150	400		V <sub>GE</sub> = 0V, V <sub>CE</sub> = 600V, T <sub>J</sub> = 175°C
V <sub>FM</sub>	Diode Forward Voltage Drop	—	1.80	2.40	V	I <sub>F</sub> = 5.0A, V <sub>GE</sub> = 0V
		—	1.32	1.74		I <sub>F</sub> = 5.0A, V <sub>GE</sub> = 0V, T <sub>J</sub> = 150°C
		—	1.23	1.62		I <sub>F</sub> = 5.0A, V <sub>GE</sub> = 0V, T <sub>J</sub> = 175°C
I <sub>GES</sub>	Gate-to-Emitter Leakage Current	—	—	±100	nA	V <sub>GE</sub> = ±20V, V <sub>CE</sub> = 0V

**Switching Characteristics @ T<sub>J</sub> = 25°C (unless otherwise specified)**

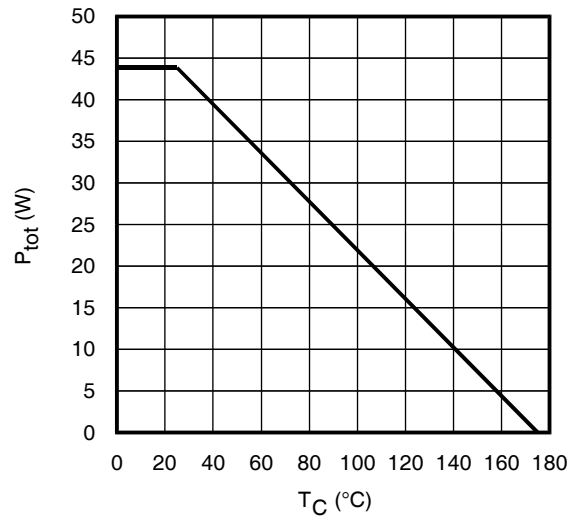
	Parameter	Min.	Typ.	Max.	Units	Conditions
Q <sub>g</sub>	Total Gate Charge (turn-on)	—	41	62	nC	I <sub>C</sub> = 10A
Q <sub>ge</sub>	Gate-to-Emitter Charge (turn-on)	—	4.6	6.9		V <sub>CC</sub> = 400V
Q <sub>gc</sub>	Gate-to-Collector Charge (turn-on)	—	19	29		V <sub>GE</sub> = 15V
E <sub>on</sub>	Turn-On Switching Loss	—	156	264	μJ	I <sub>C</sub> = 10A, V <sub>CC</sub> = 400V
E <sub>off</sub>	Turn-Off Switching Loss	—	165	273		V <sub>GE</sub> = 15V, R <sub>G</sub> = 50Ω, L = 1.07mH
E <sub>tot</sub>	Total Switching Loss	—	321	434		Ls= 150nH, T <sub>J</sub> = 25°C ⊙
t <sub>d(on)</sub>	Turn-On delay time	—	25	33	ns	I <sub>C</sub> = 10A, V <sub>CC</sub> = 400V
t <sub>r</sub>	Rise time	—	24	34		V <sub>GE</sub> = 15V, R <sub>G</sub> = 50Ω, L = 1.1mH
t <sub>d(off)</sub>	Turn-Off delay time	—	180	250		Ls= 150nH, T <sub>J</sub> = 25°C
t <sub>f</sub>	Fall time	—	62	87		
E <sub>on</sub>	Turn-On Switching Loss	—	261	372		μJ
E <sub>off</sub>	Turn-Off Switching Loss	—	313	425	V <sub>GE</sub> = 15V, R <sub>G</sub> = 50Ω, L = 1.07mH	
E <sub>tot</sub>	Total Switching Loss	—	574	694	Ls= 150nH, T <sub>J</sub> = 150°C ⊙	
t <sub>d(on)</sub>	Turn-On delay time	—	22	31	ns	I <sub>C</sub> = 8.0A, V <sub>CC</sub> = 400V
t <sub>r</sub>	Rise time	—	24	34		V <sub>GE</sub> = 15V, R <sub>G</sub> = 50Ω, L = 1.07mH
t <sub>d(off)</sub>	Turn-Off delay time	—	240	340		Ls= 150nH, T <sub>J</sub> = 150°C
t <sub>f</sub>	Fall time	—	48	67		
L <sub>E</sub>	Internal Emitter Inductance	—	7.5	—	nH	Measured 5 mm from package
C <sub>ies</sub>	Input Capacitance	—	610	915	pF	V <sub>GE</sub> = 0V
C <sub>oes</sub>	Output Capacitance	—	66	99		V <sub>CC</sub> = 30V
C <sub>res</sub>	Reverse Transfer Capacitance	—	23	35		f = 1.0MHz
RBSOA	Reverse Bias Safe Operating Area	FULL SQUARE				T <sub>J</sub> = 150°C, I <sub>C</sub> = 32A, V <sub>p</sub> = 600V V <sub>CC</sub> =500V, V <sub>GE</sub> = +15V to 0V, R <sub>G</sub> = 50Ω
SCSOA	Short Circuit Safe Operating Area	10	—	—	μs	T <sub>J</sub> = 150°C, V <sub>p</sub> = 600V, R <sub>G</sub> = 50Ω V <sub>CC</sub> =360V, V <sub>GE</sub> = +15V to 0V
I <sub>SC (PEAK)</sub>	Peak Short Circuit Collector Current	—	100	—	A	
E <sub>rec</sub>	Reverse Recovery Energy of the Diode	—	99	128	μJ	T <sub>J</sub> = 150°C
t <sub>rr</sub>	Diode Reverse Recovery Time	—	79	103	ns	V <sub>CC</sub> = 400V, I <sub>F</sub> = 10A, L = 1.07mH
I <sub>rr</sub>	Peak Reverse Recovery Current	—	14	18	A	V <sub>GE</sub> = 15V, R <sub>G</sub> = 50Ω
Q <sub>rr</sub>	Diode Reverse Recovery Charge	—	553	719	nC	di/dt = 500A/μs

⊙ V<sub>CC</sub>=80% (V<sub>CE(s)</sub>), V<sub>GE</sub> = 20V, L=100μH, R<sub>G</sub> = 50Ω.

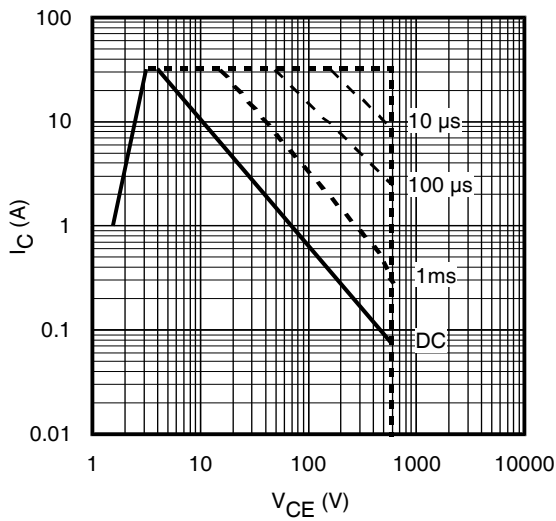
⊙ Energy losses include "tail" and diode reverse recovery.



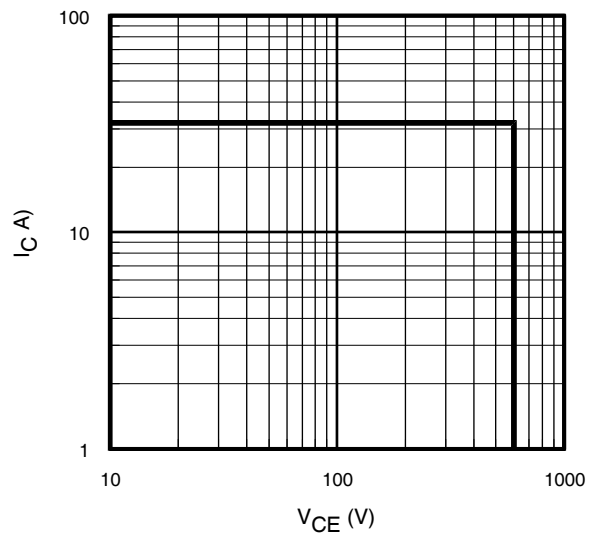
**Fig. 1** - Maximum DC Collector Current vs. Case Temperature



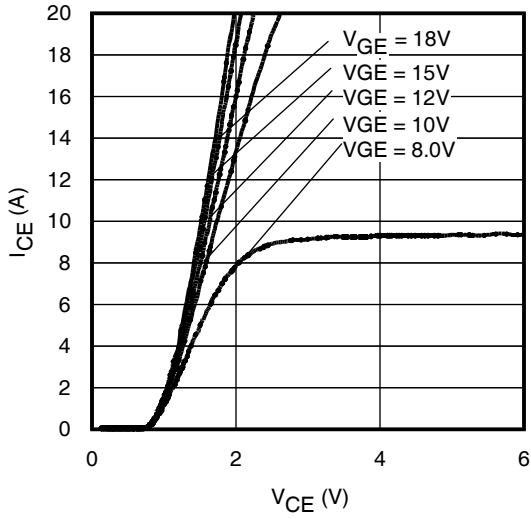
**Fig. 2** - Power Dissipation vs. Case Temperature



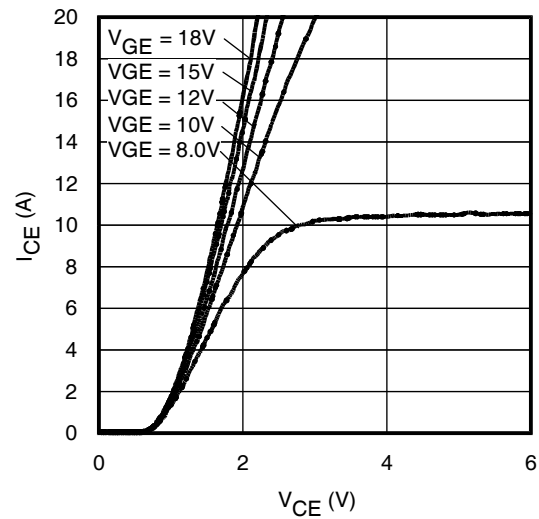
**Fig. 3** - Forward SOA  
 $T_C = 25^\circ\text{C}$ ;  $T_J \leq 175^\circ\text{C}$



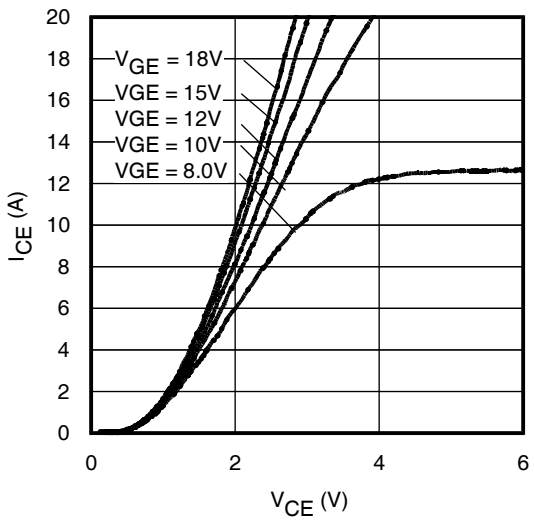
**Fig. 4** - Reverse Bias SOA  
 $T_J = 150^\circ\text{C}$ ;  $V_{GE} = 15\text{V}$



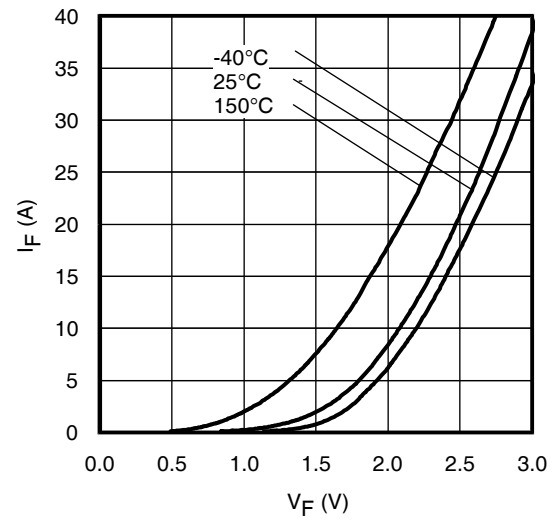
**Fig. 5** - Typ. IGBT Output Characteristics  
 $T_J = -40^\circ\text{C}$ ;  $t_p = 80\mu\text{s}$



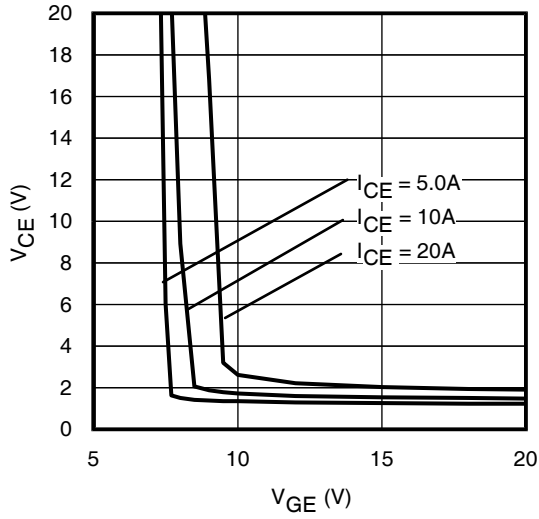
**Fig. 6** - Typ. IGBT Output Characteristics  
 $T_J = 25^\circ\text{C}$ ;  $t_p = 80\mu\text{s}$



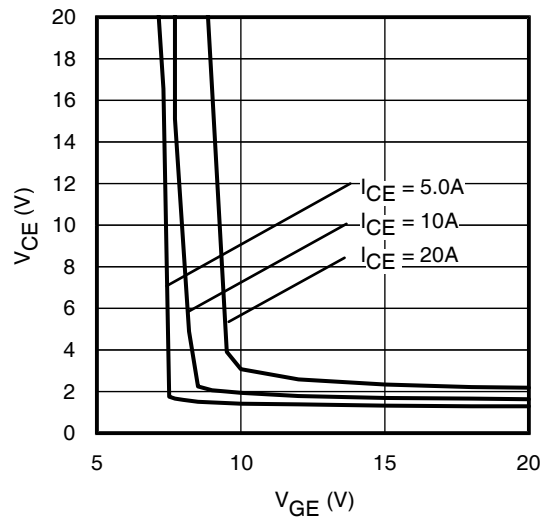
**Fig. 7** - Typ. IGBT Output Characteristics  
 $T_J = 150^\circ\text{C}$ ;  $t_p = 80\mu\text{s}$



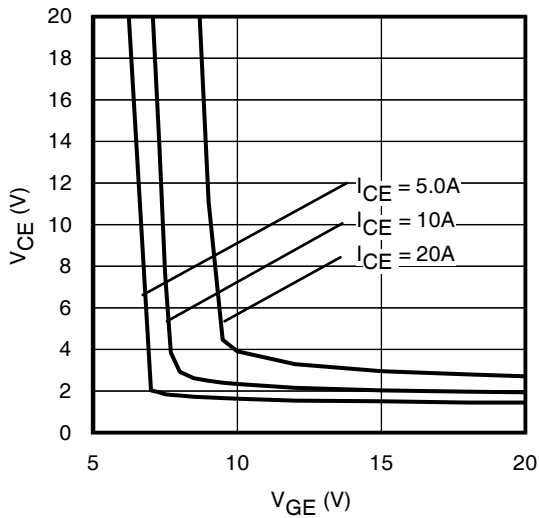
**Fig. 8** - Typ. Diode Forward Characteristics  
 $t_p = 80\mu\text{s}$



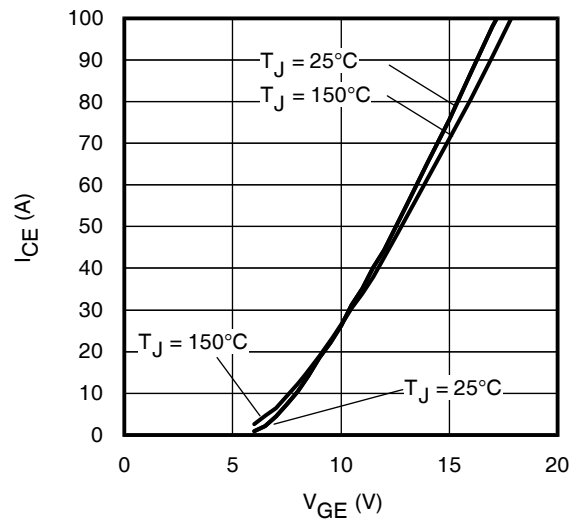
**Fig. 9** - Typical  $V_{CE}$  vs.  $V_{GE}$   
 $T_J = -40^\circ\text{C}$



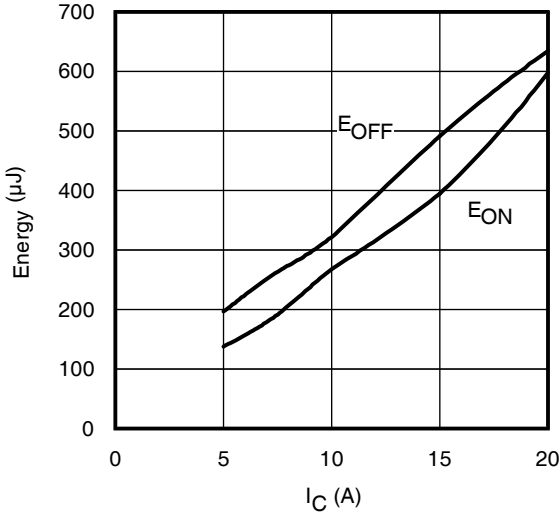
**Fig. 10** - Typical  $V_{CE}$  vs.  $V_{GE}$   
 $T_J = 25^\circ\text{C}$



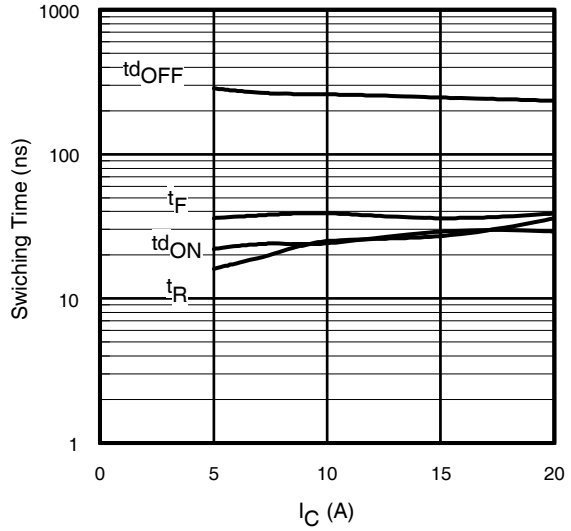
**Fig. 11** - Typical  $V_{CE}$  vs.  $V_{GE}$   
 $T_J = 150^\circ\text{C}$



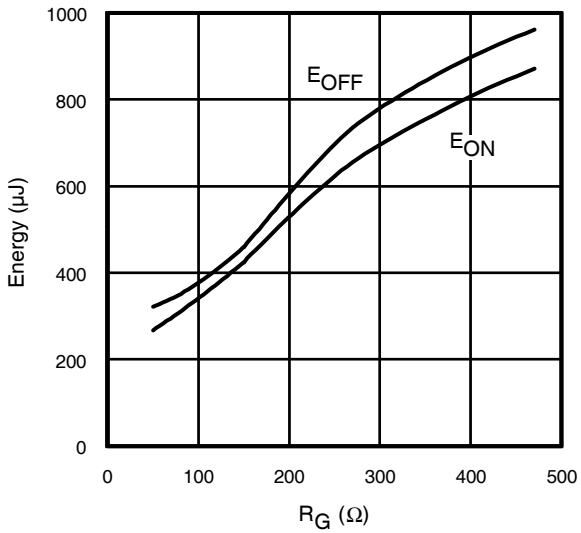
**Fig. 12** - Typ. Transfer Characteristics  
 $V_{CE} = 50\text{V}$ ;  $t_p = 10\mu\text{s}$



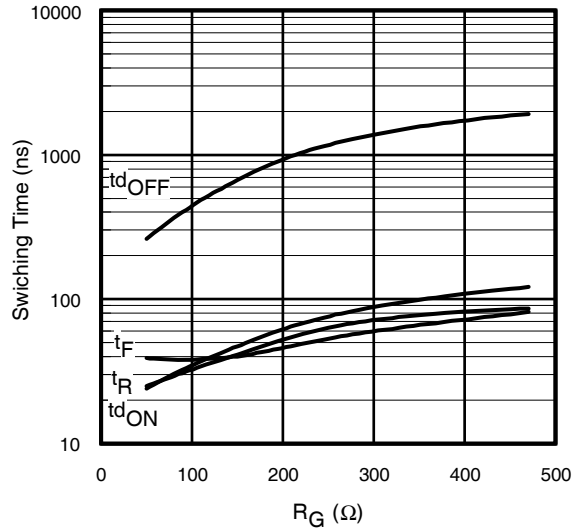
**Fig. 13** - Typ. Energy Loss vs.  $I_C$   
 $T_J = 150^\circ\text{C}$ ;  $L=1.07\text{mH}$ ;  $V_{CE}= 400\text{V}$   
 $R_G= 50\Omega$ ;  $V_{GE}= 15\text{V}$



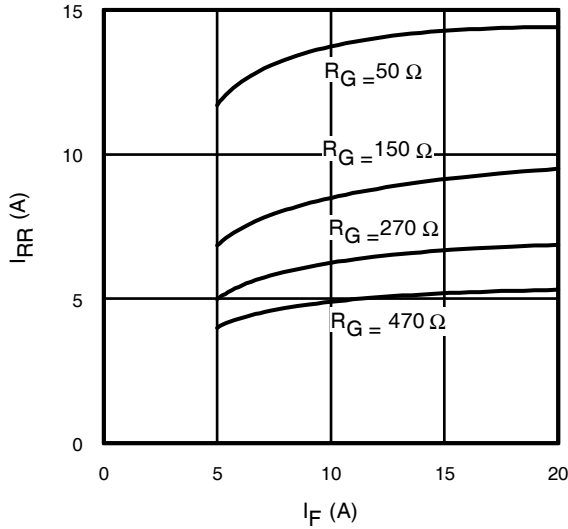
**Fig. 14** - Typ. Switching Time vs.  $I_C$   
 $T_J = 150^\circ\text{C}$ ;  $L=1.07\text{mH}$ ;  $V_{CE}= 400\text{V}$   
 $R_G= 50\Omega$ ;  $V_{GE}= 15\text{V}$



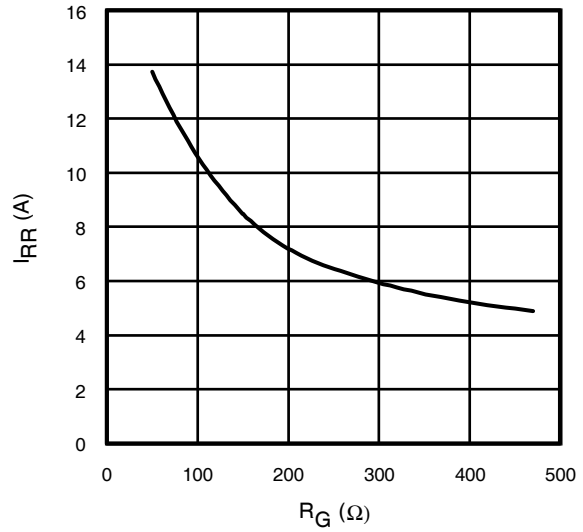
**Fig. 15** - Typ. Energy Loss vs.  $R_G$   
 $T_J = 150^\circ\text{C}$ ;  $L=1.07\text{mH}$ ;  $V_{CE}= 400\text{V}$   
 $I_{CE}= 10\text{A}$ ;  $V_{GE}= 15\text{V}$



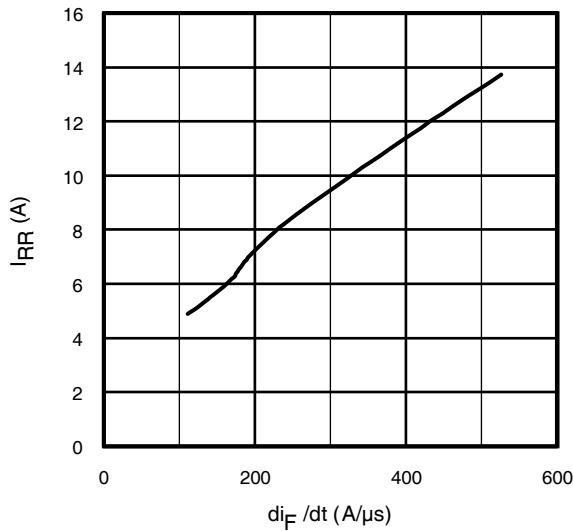
**Fig. 16** - Typ. Switching Time vs.  $R_G$   
 $T_J = 150^\circ\text{C}$ ;  $L=1.07\text{mH}$ ;  $V_{CE}= 400\text{V}$   
 $I_{CE}= 10\text{A}$ ;  $V_{GE}= 15\text{V}$



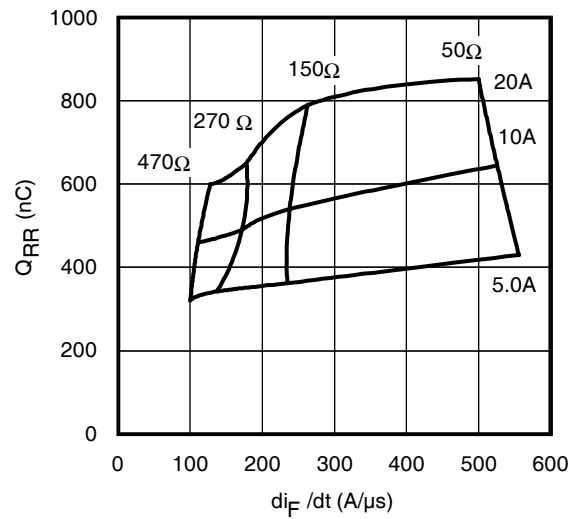
**Fig. 17** - Typical Diode  $I_{RR}$  vs.  $I_F$   
 $T_J = 150^\circ\text{C}$



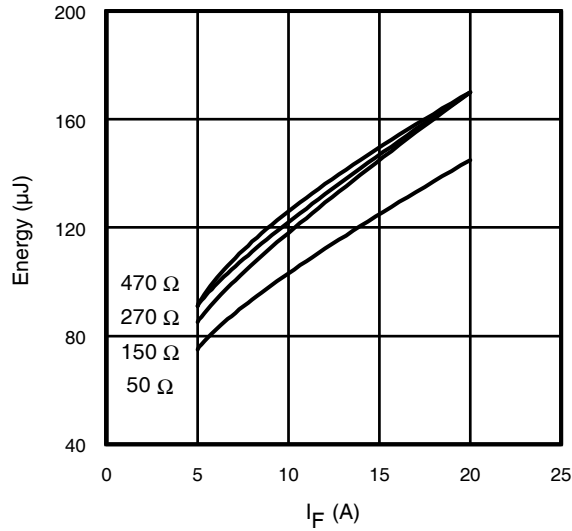
**Fig. 18** - Typical Diode  $I_{RR}$  vs.  $R_G$   
 $T_J = 150^\circ\text{C}; I_F = 10\text{A}$



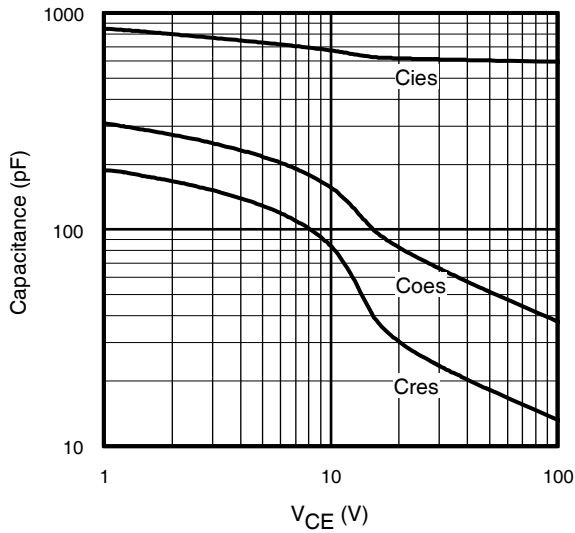
**Fig. 19**- Typical Diode  $I_{RR}$  vs.  $di_F/dt$   
 $V_{CC} = 400\text{V}; V_{GE} = 15\text{V};$   
 $I_{CE} = 10\text{A}; T_J = 150^\circ\text{C}$



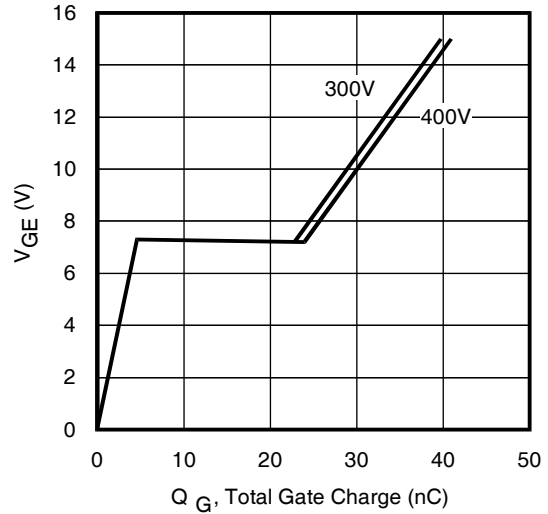
**Fig. 20** - Typical Diode  $Q_{RR}$   
 $V_{CC} = 400\text{V}; V_{GE} = 15\text{V}; T_J = 150^\circ\text{C}$



**Fig. 21** - Typical Diode  $E_{RR}$  vs.  $I_F$   
 $T_J = 150^\circ\text{C}$

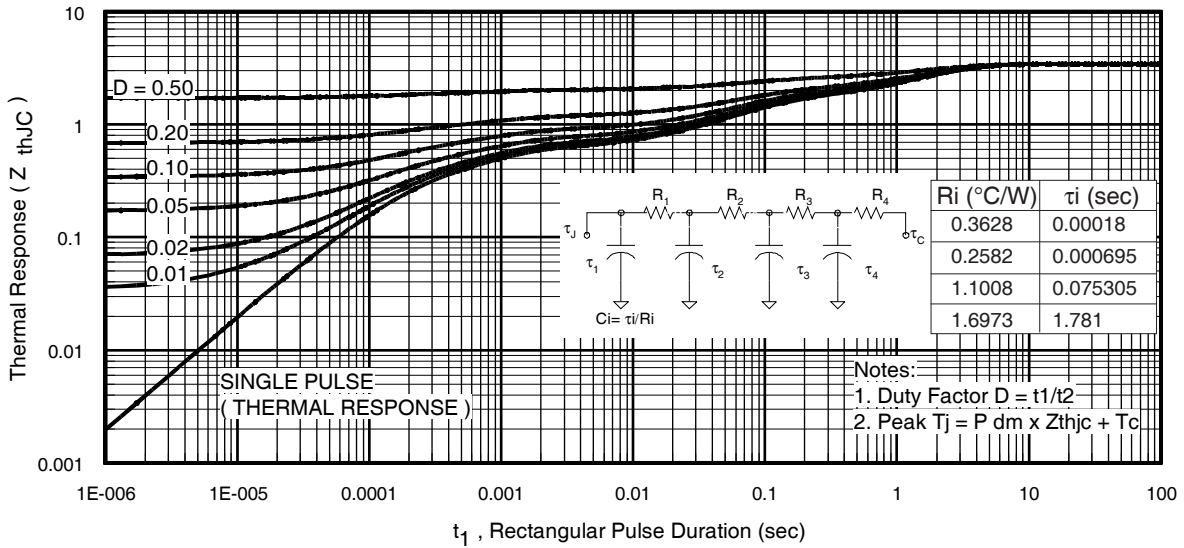


**Fig. 22**- Typ. Capacitance vs.  $V_{CE}$   
 $V_{GE} = 0\text{V}$ ;  $f = 1\text{MHz}$

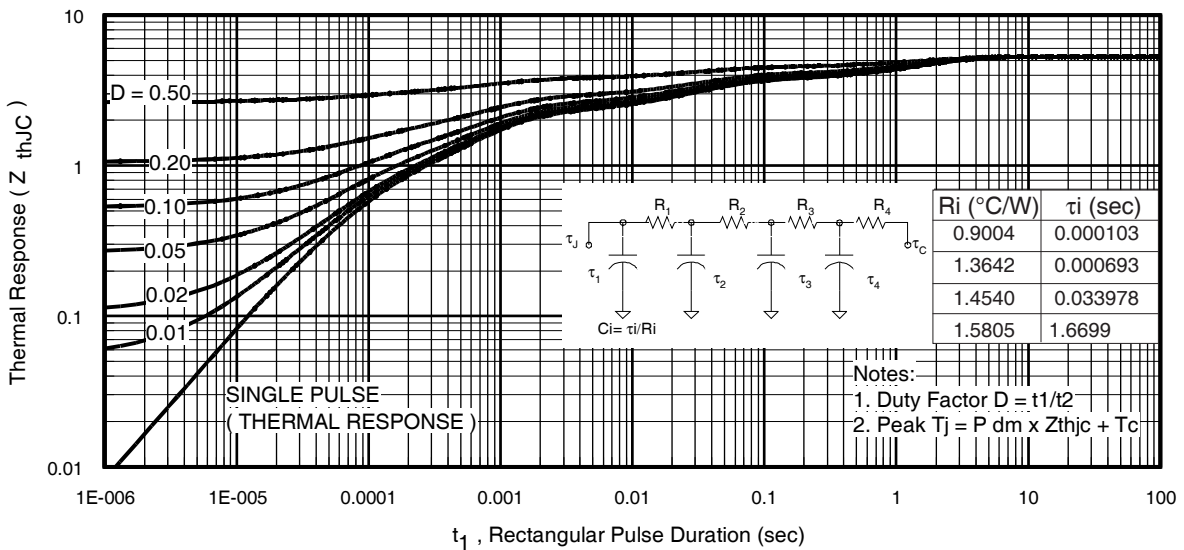


**Fig. 23** - Typical Gate Charge vs.  $V_{GE}$   
 $I_{CE} = 10\text{A}$ ;  $L = 2500\mu\text{H}$

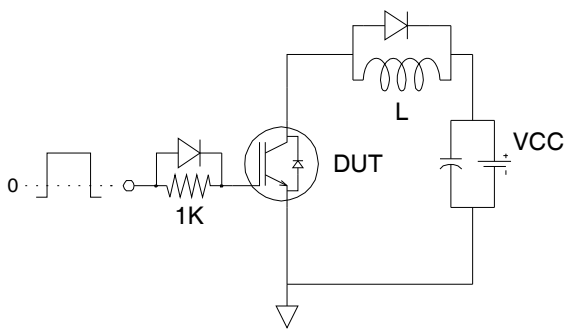




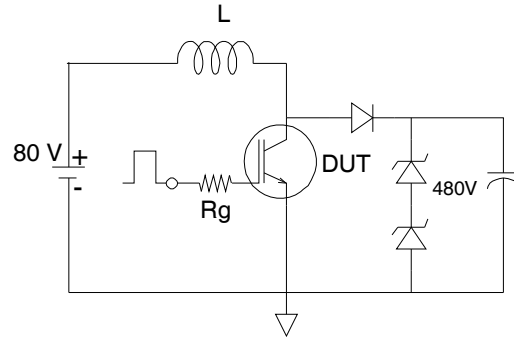
**Fig 24. Maximum Transient Thermal Impedance, Junction-to-Case (IGBT)**



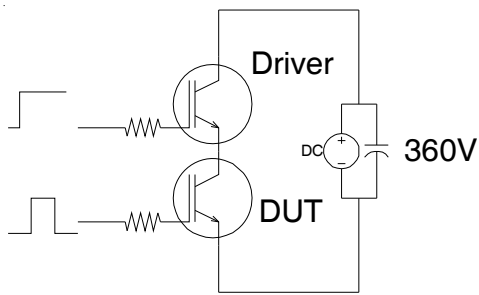
**Fig 25. Maximum Transient Thermal Impedance, Junction-to-Case (DIODE)**



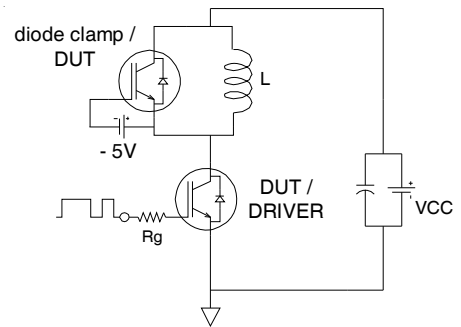
**Fig.C.T.1 - Gate Charge Circuit (turn-off)**



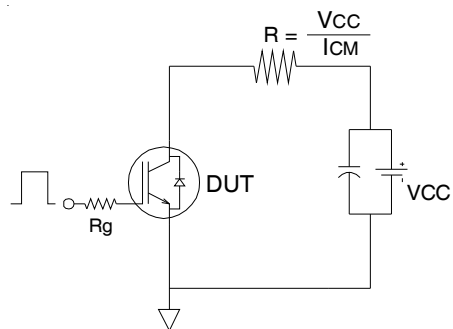
**Fig.C.T.2 - RBSOA Circuit**



**Fig.C.T.3 - S.C.SOA Circuit**



**Fig.C.T.4 - Switching Loss Circuit**



**Fig.C.T.5 - Resistive Load Circuit**

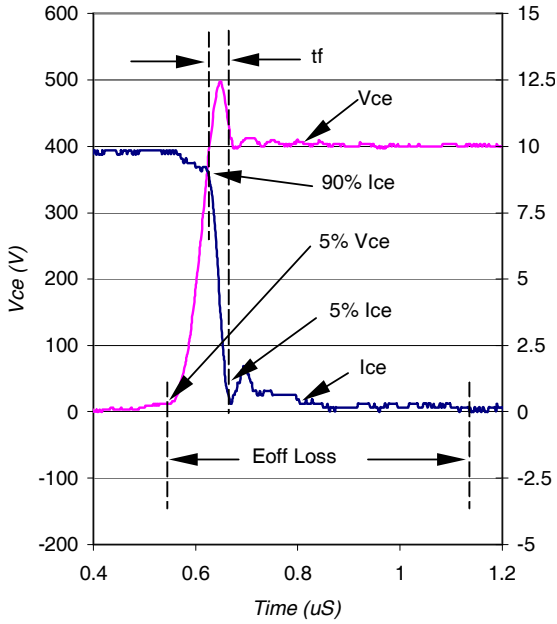


Fig. WF1- Typ. Turn-off Loss Waveform  
 @  $T_J = 150^\circ\text{C}$  using Fig. CT.4

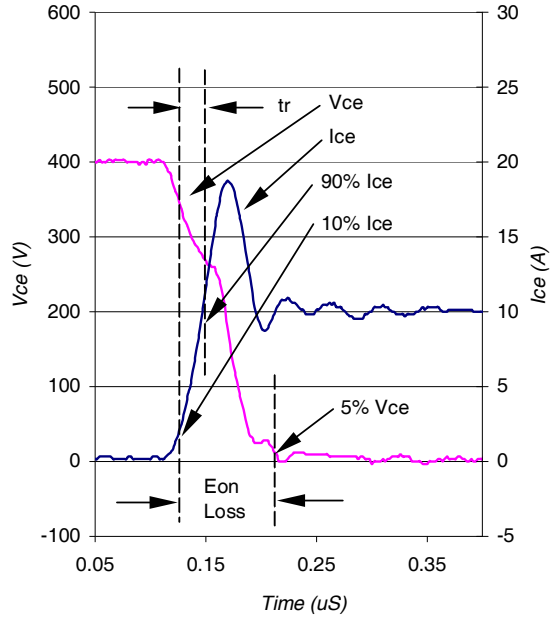


Fig. WF2- Typ. Turn-on Loss Waveform  
 @  $T_J = 150^\circ\text{C}$  using Fig. CT.4

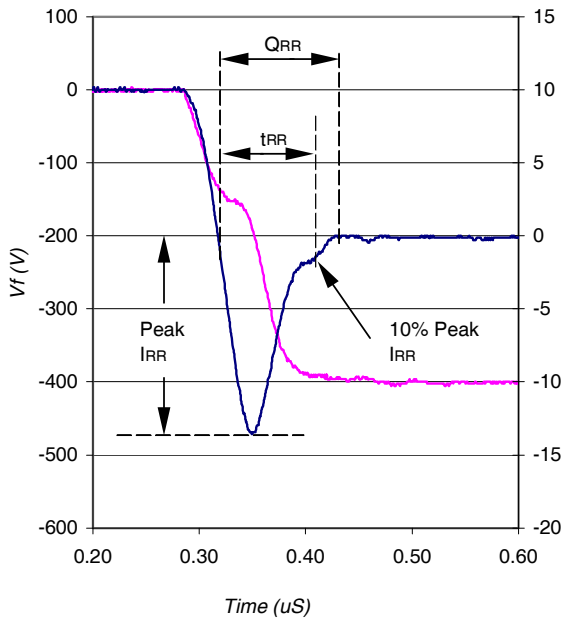


Fig. WF3- Typ. Diode Recovery Waveform  
 @  $T_J = 150^\circ\text{C}$  using Fig. CT.4

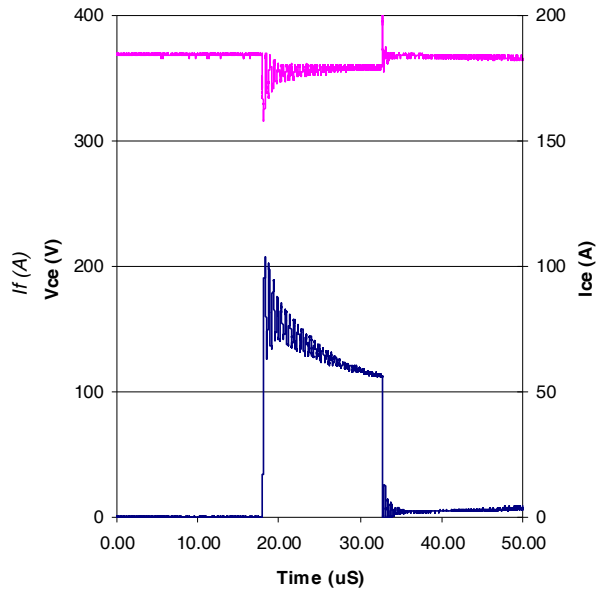
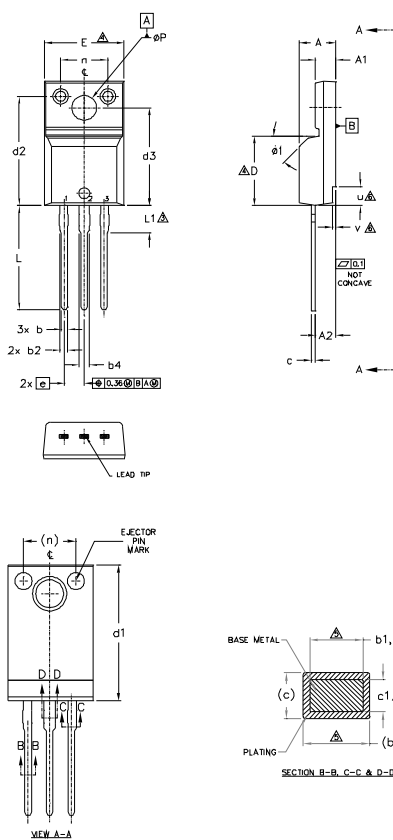


Fig. WF4- Typ. S.C Waveform  
 @  $T_C = 150^\circ\text{C}$  using Fig. CT.3

## TO-220 Full-Pak Package Outline

Dimensions are shown in millimeters (inches)



NOTES:  
 1.0 DIMENSIONING AND TOLERANCING AS PER ASME Y14.5 M - 1994.  
 2.0 DIMENSIONS ARE SHOWN IN MILLIMETERS (INCHES)  
 3.0 LEAD DIMENSION AND FINISH UNCONTROLLED IN L1  
 4.0 DIMENSION D & C DO NOT INCLUDE MOLD FLASH; MOLD FLASH SHALL NOT EXCEED .005" (0.127) PER SIDE. THESE DIMENSIONS ARE MEASURED AT THE OUTER MOST EXTREMES OF THE PLASTIC BODY.  
 5.0 DIMENSION n1, n2, n3 & n4 APPLY TO BASE METAL ONLY.  
 6.0 STEP OPTIONAL ON PLASTIC BODY DEFINED BY DIMENSIONS u & v.  
 7.0 CONTROLLING DIMENSION = INCHES.

**LEAD ASSIGNMENTS**

- HEXFLI
- 1- GATE
- 2- DRAIN
- 3- SOURCE

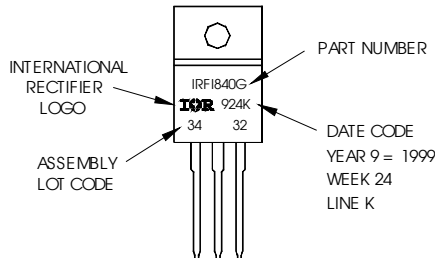
- BESL: GATE
- 1- GATE
- 2- COLLECTOR
- 3- EMITTER

SYMBOL	DIMENSIONS				NOTES
	MILLIMETERS		INCHES		
	MIN.	MAX.	MIN.	MAX.	
A	4.57	4.83	.180	.190	
A1	2.57	2.82	.101	.111	
A2	2.51	2.92	.099	.115	
b	0.61	0.94	.024	.037	
b1	0.61	0.89	.024	.035	5
b2	0.76	1.27	.030	.050	
b3	0.76	1.22	.030	.048	5
b4	1.02	1.52	.040	.060	
b5	1.02	1.47	.040	.058	5
c	0.33	0.63	.013	.025	
c1	0.33	0.58	.013	.023	5
D	8.66	9.80	.341	.386	4
d1	15.80	16.13	.622	.635	
d2	13.97	14.22	.550	.560	
d3	12.29	12.93	.484	.509	
E	9.63	10.74	.379	.423	4
e	2.54	BSC	.100	BSC	
L	13.21	13.72	.520	.540	
L1	3.10	3.68	.122	.145	3
n	6.05	6.60	.238	.260	
φP	3.05	3.45	.120	.136	
u	2.39	2.49	.094	.098	6
v	0.41	0.51	.016	.020	6
φ1	-	45°	-	45°	

## TO-220 Full-Pak Part Marking Information

EXAMPLE: THIS IS AN IRF1840G  
 WITH ASSEMBLY  
 LOT CODE 3432  
 ASSEMBLED ON WW 24 1999  
 IN THE ASSEMBLY LINE "K"

**Note:** "P" in assembly line position indicates "Lead-Free"



TO-220 Full-Pak package is not recommended for Surface Mount Application

**Note:** For the most current drawing please refer to IR website at: <http://www.irf.com/package/>

**Qualification Information<sup>†</sup>**

<b>Qualification Level</b>	Industrial (per JEDEC JESD47F) <sup>††</sup>	
<b>Moisture Sensitivity Level</b>	TO-220AB-Full-Pak	N/A
<b>RoHS Compliant</b>	Yes	

† Qualification standards can be found at International Rectifier's web site <http://www.irf.com/product-info/reliability>

†† Applicable version of JEDEC standard at the time of product release.

**Revision History**

<b>Date</b>	<b>Comments</b>
8/4/2015	<ul style="list-style-type: none"> <li>• Updated data sheet with the new corporate template.</li> <li>• Added feature "UL Certified" on page 1.</li> <li>• Updated package outline on page 12.</li> <li>• Updated note ① from "V<sub>GE</sub> = 15V" to "V<sub>GE</sub> = 20V" on page 2.</li> </ul>