

EVA-O

~40° x 15° oval beam

TECHNICAL SPECIFICATIONS:

Dimensions	Ø 35 mm
Height	16.4 mm
Fastening	
Colour	clear
Box size	480 x 280 x 300 mm
Box weight	5.6 kg
Quantity in Box	675 pcs
ROHS compliant	yes ⓘ



MATERIAL SPECIFICATIONS:

Component	Type	Material	Colour
EVA-O	Lens	PMMA	clear

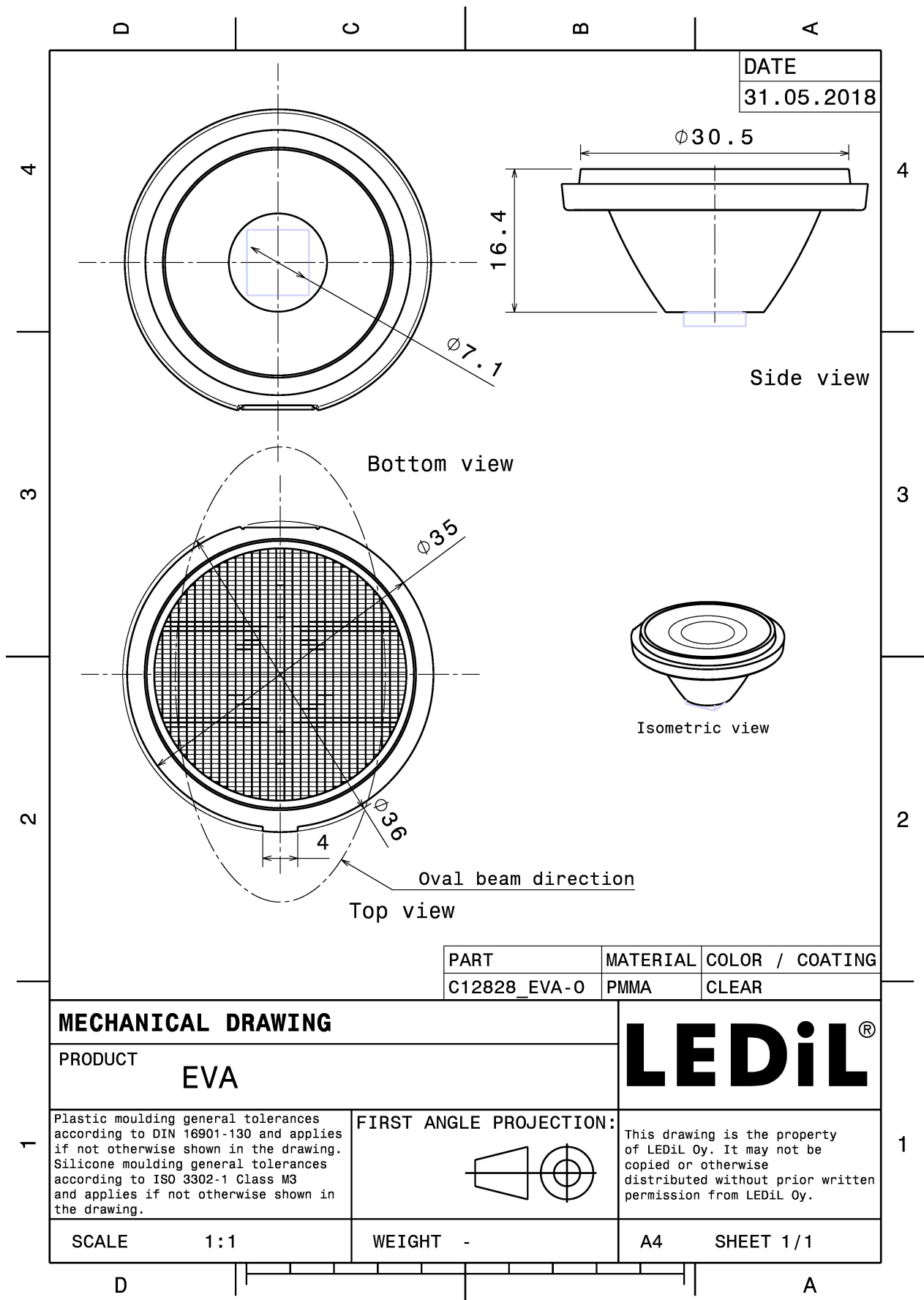

PHOTOMETRIC DATA (MEASURED):

CITIZEN

LED CLU LES 4.2mm (HI-Ver.3)
FWHM 39.0 + 15.0°
Efficiency 89 %
Peak intensity 3.700 cd/lm
Required components:

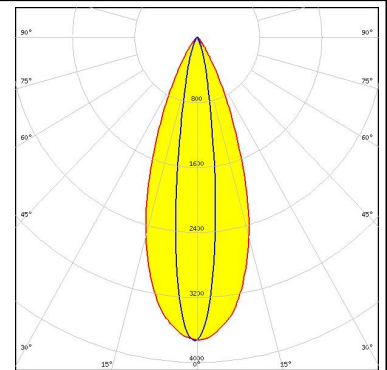

CREE ⇄

LED MHB-A/B
FWHM 39.0 + 18.0°
Efficiency 81 %
Peak intensity 3.100 cd/lm
Required components:

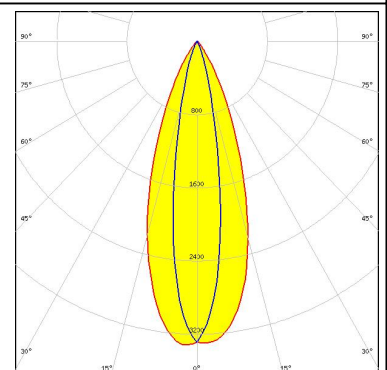
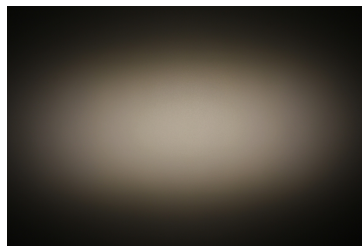

CREE ⇄

LED XHP35 HI
FWHM 39.0 + 21.0°
Efficiency 81 %
Peak intensity 2.200 cd/lm
Required components:

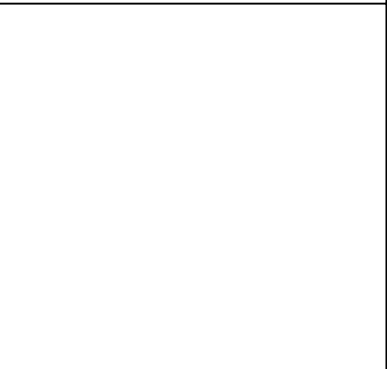
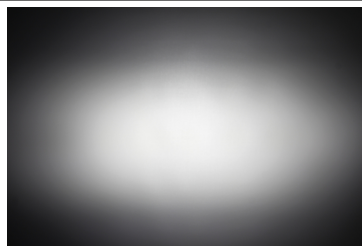

CREE ⇄

LED XM-L
FWHM 15.5 + 39.0°
Efficiency 86 %
Peak intensity 3.300 cd/lm
Required components:

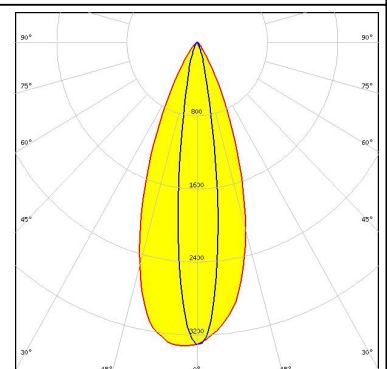

PHOTOMETRIC DATA (MEASURED):

LUMILEDS

LED LUXEON M/MX
FWHM 20.5 + 37.0°
Efficiency 83 %
Peak intensity 2.700 cd/lm
Required components:

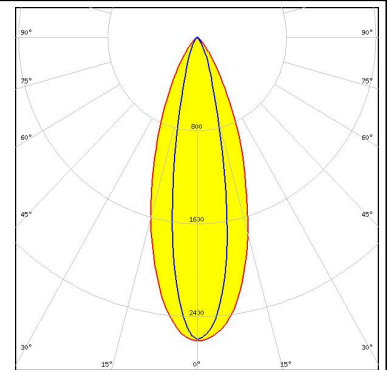
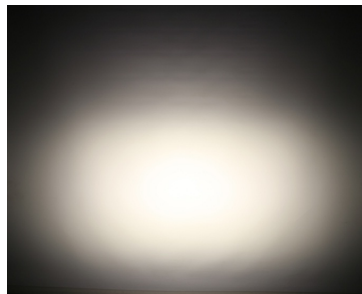

LUMILEDS

LED LUXEON MZ
FWHM 39.0 + 15.0°
Efficiency 86 %
Peak intensity 4.000 cd/lm
Required components:

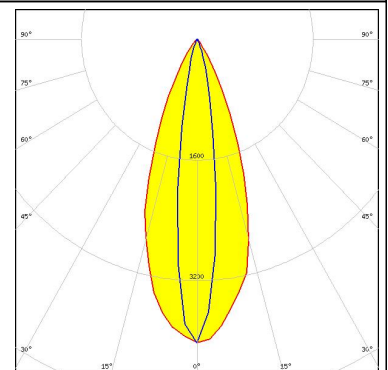

NICHIA

LED NS9x383
FWHM 39.0 + 15.0°
Efficiency 87 %
Peak intensity 3.700 cd/lm
Required components:

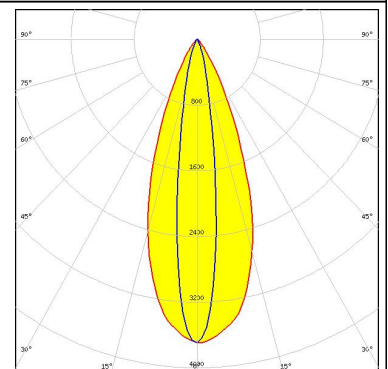
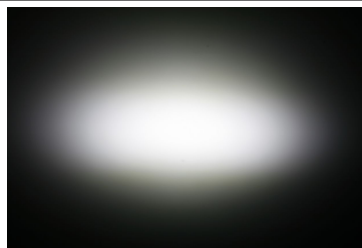

NICHIA

LED NSMx286M
FWHM 40.0 + 20.0°
Efficiency 86 %
Peak intensity 2.570 cd/lm
Required components:

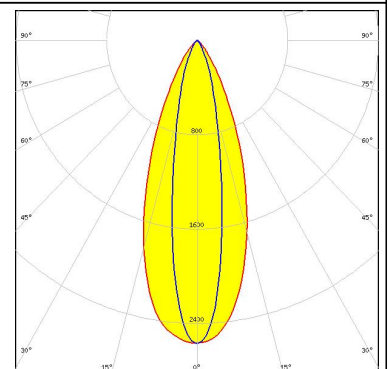

PHOTOMETRIC DATA (MEASURED):

OSRAM
Opto Semiconductors

LED Duris S8
FWHM 39.0 + 17.0°
Efficiency 88 %
Peak intensity 3.700 cd/lm
Required components:

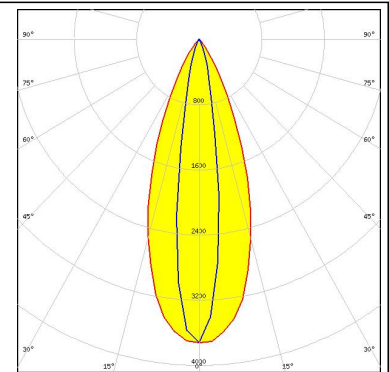

SEOL
SEOUL SEMICONDUCTOR

LED Z8Y15
FWHM 41.0 + 13.0°
Efficiency 85 %
Peak intensity 4.880 cd/lm
Required components:

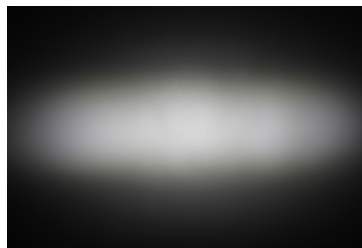

SEOL
SEOUL SEMICONDUCTOR

LED Z8Y19
FWHM 41.0 + 12.0°
Efficiency 86 %
Peak intensity 4.870 cd/lm
Required components:

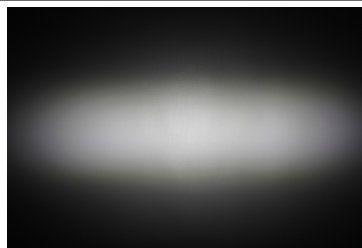

PHOTOMETRIC DATA (SIMULATED):



LED MC-E
 FWHM 16.0 + 40.0°
 Efficiency %
 Peak intensity cd/lm
 Required components:

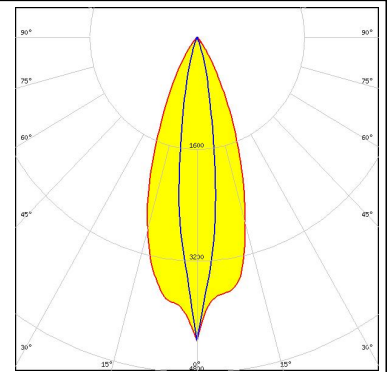

LED XP-G2
 FWHM 17.0 + 34.0°
 Efficiency 91 %
 Peak intensity 4.000 cd/lm
 Required components:

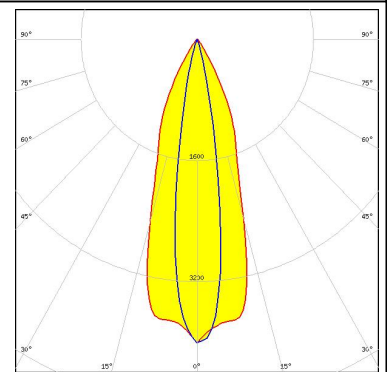

LED LUXEON 5258
 FWHM 16.0 + 37.0°
 Efficiency 91 %
 Peak intensity 3.700 cd/lm
 Required components:

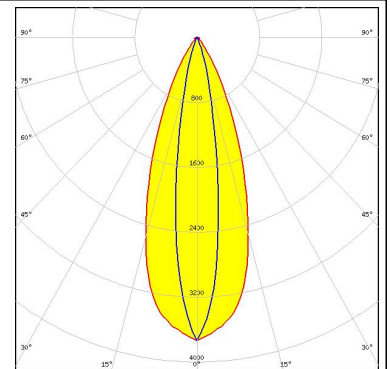

LED OSCONIQ P 7070
 FWHM 19.0 + 37.0°
 Efficiency 92 %
 Peak intensity 3.320 cd/lm
 Required components:

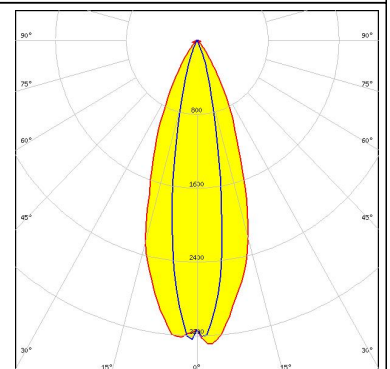

GENERAL INFORMATION:

NOTE: The typical beam angle will be changed by different color, chip size and chip position tolerance. The typical total beam angle is the full angle measured where the luminous intensity is half of the peak value.

Due to use of high power COB's with this product, special attention to proper thermal design is highly recommended. LEDiL has no liability for direct, indirect or consecutive damages arising from the LEDiL products being used outside of the recommended temperature range.

MATERIALS:

As part of our continuous research and improvement processes, and to ensure the best possible quality and availability of our products, LEDiL reserves the right to change material grades without notice.

PRODUCT DATA USER AGREEMENT AND DISCLAIMER:

The measured data in the provided downloadable LEDiL Product Datasheets and Mechanical 2D-Drawings is rounded and provided as reference for planning. LEDiL Oy's optical specifications have been verified by conducting performance testing of the products in accordance with the company's quality system. The reported data are averaged results of multiple measurements with typical variation. LEDiL Oy reserves the right to without prior notification make changes and improvements to its products.

LEDiL Oy assumes neither warranty, nor guarantee nor any other liability of any kind for the contents and correctness of the provided data. The provided data has been generated with highest diligence but the provided data may in reality not represent the complete possible variation range of all intrinsic parameters. Therefore, in certain cases a deviation from the provided data could occur.

LEDiL Oy reserves the right to undertake technical changes of its products without further notification which could lead to changes in the provided data. LEDiL Oy assumes no liability of any kind for the possible deviation from any provided data or any other damage resulting from the usage of the provided data.

The user agrees to this disclaimer and user agreement with the download or usage of the provided files.

LEDiL Oy

Joensuunkatu 13
FI-24240 SALO
Finland

LEDiL Inc.

228 West Page Street
Suite D
Sycamore IL 60178
USA

Local sales and technical support

[www.ledil.com/
where_to_buy](http://www.ledil.com/where_to_buy)

Shipping locations

Salo, Finland
Hong Kong, China

Distribution Partners

[www.ledil.com/
where_to_buy](http://www.ledil.com/where_to_buy)