

Evaluating the **ADM1266** Super Sequencer with Interchip Bus

FEATURES

Sequencing and supervision of 16 power supplies
Trim and margin functions for 9 power supplies
Automatic fault logging to internal EEPROM
Operates autonomously without additional software
PMBus interface supports all device related software
Interchip bus simplifies multidevice cascading and sequencing operation
16 voltage references for input emulation
Switches and LEDs for signal emulation using GPIOs

ADM1266-EVALZ EVALUATION KIT CONTENTS

ADM1266 main evaluation board
ADM1266 POL evaluation board

ADDITIONAL HARDWARE NEEDED

USB to I²C dongle
5 V to 15 V power supply

SOFTWARE NEEDED

Analog Devices, Inc., **Power Studio**

GENERAL DESCRIPTION

The ADM1266-EVALZ is a demonstration system for the **ADM1266** 16-channel, I²C/SMBus/PMBus Super Sequencer®. The **ADM1266** monitors and controls 16 power supply rails. The ADM1266-EVALZ demonstrates the ability of the **ADM1266** to sequence, trim, margin, supervise, monitor, and log faults for these 16 power supply rails. The output voltage of each power supply channel is monitored by the **ADM1266**.

The ADM1266-EVALZ is a single-circuit board containing 14 **ADP1710** 150 mA linear regulators and two **ADP7102** 300 mA linear regulators. Each linear regulator is controlled by the **ADM1266**. The ADM1266-EVALZ provides a sophisticated, 16-channel, digitally programmable power supply system.

The ADM1266-EVALZ demonstration system is supported by the Analog Devices **Power Studio**™ graphical user interface (GUI), enabling complete control of all features of the **ADM1266**. Together, the **Power Studio** software and the ADM1266-EVALZ hardware system create a powerful development environment for designing and testing **ADM1266** configuration settings. These settings can be stored in the internal EEPROM of the device, or the settings can be stored in a file. This file can be later used to order pre-programmed devices or to program devices in a production environment. The software displays all the configuration settings and real-time measurements from the **ADM1266**. Telemetry allows easy access and decoding of the fault log created by the **ADM1266**. The board is preprogrammed with the EEPROM values appropriate for the 16 power supplies used on the ADM1266-EVALZ.

Multiple ADM1266-EVALZ boards can be cascaded together to form a high channel count power supply (see the Multiple Board Setup section). This cascaded configuration demonstrates the features of the **ADM1266** that enable sequencing and fault information to be shared across multiple ICs. The user can configure up to 16 ADM1266-EVALZ boards, thereby controlling up to 256 separate power supply rails. Larger arrays of **ADM1266** devices are supported through the programmable I²C base address.

The ADM1266-EVALZ demonstration board can be powered by an external power supply, such as a 12 V dc supply. Communication with the software is provided through the **EVAL-ADP-I2C-USB**.

TABLE OF CONTENTS

Features	1	Quick Start Procedure	7
EVAL-ADM1266EBZ Evaluation Kit Contents	1	Loading the Configuration (*.ssp) File with the GUI	7
Additional Hardware Needed	1	Common Demonstration Board Operations	8
Software Needed	1	Sequencing	8
General Description	1	Fault Handling	8
Revision History	2	Telemetry and Blackbox	9
Power Studio GUI Software	3	Margining	10
Evaluation Board Introduction	4	Multiple Board Setup	10
Evaluation Board Description	5	Evaluation Board Schematics and Artwork	11
Power Supplies	5	Main Evaluation Board Schematics	12
Input Emulation	5	POL Board Schematics	14
Regulator Mapping	5	Ordering Information	16
Output Signal	5	Bill of Materials	16
PMBus Interface	5		
PMBus Address selection	6		

REVISION HISTORY

5/2018—Revision 0: Initial Version

POWER STUDIO GUI SOFTWARE

Power Studio is a powerful, Windows-based development environment that supports the ADM1266 and ADM1260 Super Sequencer ICs. The software supports a variety of different tasks. Power Studio can be used to evaluate Analog Devices ICs by connecting to a demonstration board system. Power Studio can also be used in an offline mode (with no hardware present) to build a multichip configuration file that can be saved and

reloaded at a later time. Power Studio provides unprecedented diagnostic and debugging features. The software is a valuable diagnostic tool during board configuration to program or adjust the power management scheme in a system, or to diagnose power issues when configuring rails. Power Studio uses the EVAL-ADP-12C-USB controller to communicate with the ADM1266-EVALZ demonstration system, or to communicate with a customer board.

MENU TO BROWSE THROUGH THE DIFFERENT CONFIGURATION AND MONITOR WINDOWS

ICONS TO SHOW PARTS STATUS AND COMPILE OPTIONS

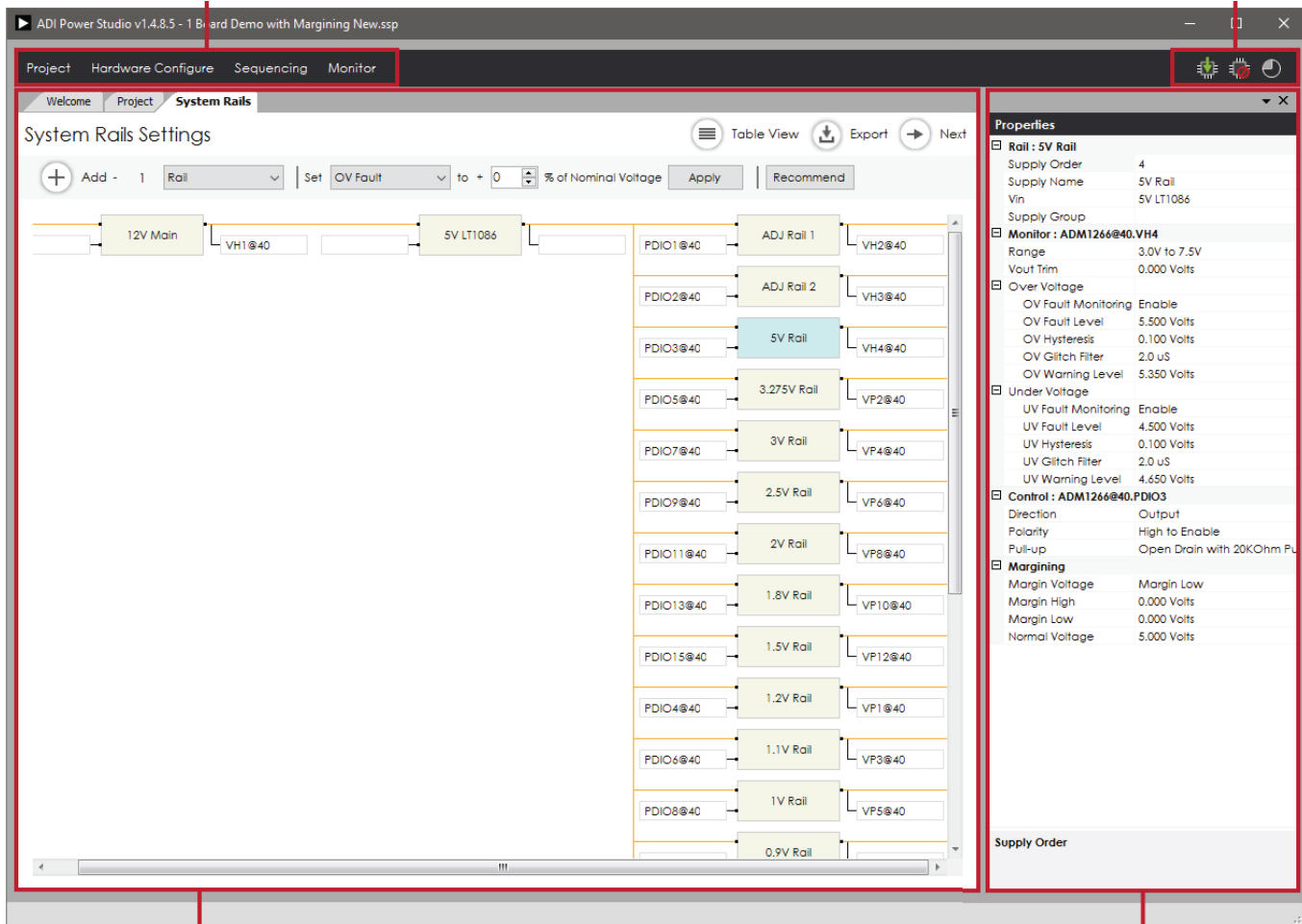

CONFIGURATION AND MONITOR WINDOWS OPEN HERE

PROPERTIES WINDOW TO ACCESS DIFFERENT SETTINGS FOR THE ITEMS SELECTED IN THE WINDOW ON THE LEFT

Figure 1. Power Studio GUI

156608-001

EVALUATION BOARD INTRODUCTION

See Table 1 for descriptions of the evaluation board components shown in Figure 2.

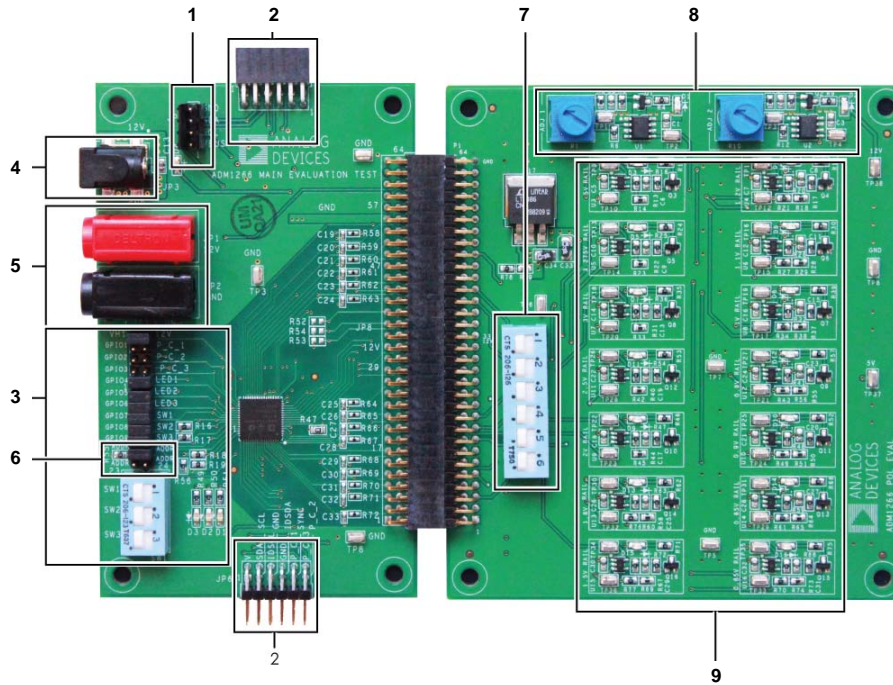

Figure 2. Evaluation Board Components

Table 1. Evaluation Board Components

Number	Component	Description
1	PMBus dongle connector	Connects the dongle to the board for programming the ADM1266 . The EVAL-ADP-I2C-USB dongle must be purchased separately.
2	Multiple board connector	Connects up to 16 ADM1266 evaluation boards together. This connector carries PMBus lines, interdevice bus (IDB) lines, and power (12 V and GND) across all the connected boards.
3	General-purpose input/output (GPIO) development area	This area consists of three switches and three light emitting diodes (LEDs). Connect the GPIOs to the switches and the LEDs to emulate signals on the board.
4	Power adapter connector	Connect the power adapter connector to the wall power adapter to power the evaluation board.
5	Bench power supply connector	Connects the bench power supply to power up the board.
6	Address selection jumpers	Selects the PMBus address for the ADM1266 . If the jumper is on Address 1, then the address is 0x40. If the jumper is on Address 2, then the address is 0x42.
7	Single-/differential-ended sensing switches	Keep these switches to the left position for single-ended sensing, and to the right position for differential sensing.
8	Adjustable rails	The board has two regulators. The output on the regulators ranges from 1.2 V to 12 V by varying the potentiometers.
9	Fixed rails	The board has 14 regulators. The outputs of these regulators are fixed, from the highest voltage being 5 V and the lowest being 0.85 V.

146609-002

EVALUATION BOARD DESCRIPTION

The ADM1266-EVALZ evaluation board is designed to evaluate the [ADM1266](#) Super Sequencer IC. The board is easy to use, easy to probe, allows flexible wiring, and is capable of supporting large, multidevice systems by cascading multiple boards.

POWER SUPPLIES

The evaluation board can accept 9 V to 14.4 V from a bench power supply through Connector JP1 and Connector JP2. The evaluation board also supports a wall mountable switching power supply with a voltage range from 9 V to 14.4 V using Connector J4. The current consumption of a single board depends on the exact configuration of the board and sequence. However, the current consumption is typically less than 200 mA.

INPUT EMULATION

Sixteen on-board, adjustable voltage regulators from Analog Devices provide input supply emulation for all the different setups supported by the [ADM1266](#).

Each regulator operates independently and the output voltages can be easily adjusted.

Each regulator can be enabled or disabled by the [ADM1266](#). An LED indicates the on or off status for each regulator.

Each regulator has a feedback pin that allows the user to evaluate the margining function of the [ADM1266](#).

Set Switch SW4 as shown in Figure 2 for single-ended sensing. If the switches are kept to the right side position, the corresponding voltage is differentially sensed. Differential sensing is only available for Regulator 4, Regulator 6, Regulator 8, Regulator 10, Regulator 12, and Regulator 14. When a voltage is differentially sensed, the voltage sensing for the corresponding odd numbered regulator is disabled. For example, if differential sensing is enabled on Regulator 4, then the voltage of Regulator 5 is not sensed.

REGULATOR MAPPING

The voltage sensing and enable control for the regulators are connected in the order shown in Table 2.

Table 2. Regulator Mapping

Order Number	Regulator Name	Voltage Sensing	Enable Pin
1	ADJ1	VH2	PDIO1
2	ADJ2	VH3	PDIO2
3	5 V rail	VH4	PDIO3
4	1.2 V rail	VP1	PDIO4
5	3.275 V rail	VP2	PDIO5
6	1.1 V rail	VP3	PDIO6
7	3 V rail	VP4	PDIO7
8	1 V rail	VP5	PDIO8
9	2.5 V rail	VP6	PDIO9
10	0.9 V Rail 1	VP7	PDIO10
11	2 V rail	VP8	PDIO11
12	0.9 V Rail 2	VP9	PDIO12
13	1.8 V rail	VP10	PDIO13
14	0.85 V Rail 1	VP11	PDIO14
15	1.5 V rail	VP12	PDIO15
16	0.85 V Rail 2	VP13	PDIO16

OUTPUT SIGNAL

The PDIOx output signals from the [ADM1266](#) are connected to the enable the signal or pin of the regulators and allow the board to perform simulations of real-world sequencing applications.

PMBus INTERFACE

The evaluation board supports a PMBus interface. The user can connect the PMBus end of the dongle from the PC USB port to the board using the [EVAL-ADP-I2C-USB](#).

PMBus ADDRESS SELECTION

Table 3 shows the PMBus address settings.

Table 3. PMBus Address Settings

PMBus Address	1% Resistor (kΩ) (E96 series)
0x40	0.422
0x41	1.5
0x42	2.67
0x43	4.12
0x44	5.36
0x45	7.15
0x46	8.87
0x47	10.7
0x48	12.7
0x49	14.7
0x4A	16.9
0x4B	19.1
0x4C	21.5
0x4D	24.3
0x4E	27.4
0x4F	31.6

QUICK START PROCEDURE

The following procedure describes how to set up the ADM1266-EVALZ demonstration system:

1. Download and install the Analog Devices [Power Studio](#) GUI.
2. Remove the board from the ESD protective bag and place it on a level surface. Connect the [EVAL-ADP-I2C-USB](#) controller to the ADM1266-EVALZ board using the 4-pin ribbon cable to JP4.
3. Confirm that all the switches on the main board and point of load (POL) board are set as shown in Figure 2.
4. Connect a 12 V dc power supply with >0.5 A capacity to the JP1 and JP2 connectors of the ADM1266-EVALZ board.
5. Plug the [EVAL-ADP-I2C-USB](#) controller in to a USB port on your PC.
6. Launch the Analog Devices [Power Studio](#) GUI. The GUI automatically identifies the [ADM1266](#) on the ADM1266-EVALZ board.

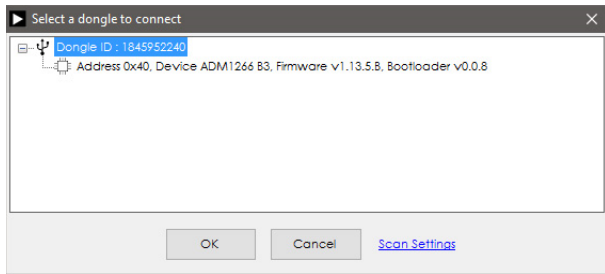

Figure 3. Devices Connected to Power Studio

7. On the top right corner, the GUI shows that one device is connected to the GUI (see Figure 4).

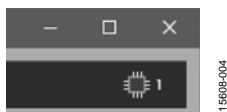

Figure 4. Device Number Indicator

8. Click the **Restore Project From Hardware...** button (see Figure 5).



Figure 5. Restore Project From Hardware... Button

9. The prompt shown in Figure 6 appears. Click **OK**.

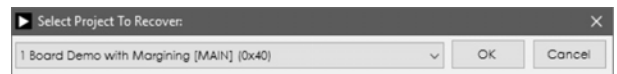

Figure 6. Project Recovery Prompt

10. The project is restored from the [ADM1266](#) and is loaded into the GUI.
11. Save the demonstration board configuration to a *.ssp file by clicking **Project** and then **Save Project** in the menu on the top left of the GUI. Name the file to create a backup file on your computer.

LOADING THE CONFIGURATION (*.SSP) FILE WITH THE GUI

Use the following procedure to load the configuration (*.ssp) file with the GUI:

1. If you have just started the GUI, click **Project**, then **Open Project**, and browse to the configuration file to load.
2. If you already have a configuration open, click **Project**, then **Close Project**, and follow Step 1.
3. After loading the file in the GUI, click the **Compile and Program Device(s)** icon (see Figure 7) to load the configuration to the [ADM1266](#) nonvolatile memory (NVM).

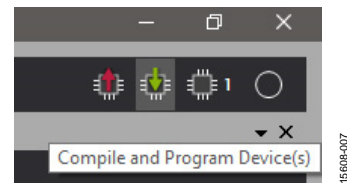

Figure 7. Compile and Program Device(s) Icon

COMMON DEMONSTRATION BOARD OPERATIONS SEQUENCING

The ADM1266-EVALZ board is preprogrammed to sequence up and sequence down all 16 rails. The sequence up state machine is created to enable a rail, monitor, and the corresponding output to be stable for 200 ms, and to then proceed to the next state to enable the next rail. For sequence down operation, the state machine is created to disable a rail, wait 200 ms, and then proceed to disable the next rail. The rails sequence down in the reverse order of the sequence up operation.

GPIO7 is connected to SW1 and is configured as the ENABLE_L signal. If ENABLE_L is low, then the device sequences up. If ENABLE_L is toggled to a high position, then the device sequences down and waits for the ENABLE_L signal to be toggled low.

GPIO4 is connected to LED1 and is configured as POWER_GOOD. When all the rails are successfully sequenced up and reach the power-good state, then the POWER_GOOD signal is turned high. When all the rails successfully sequence down and reach the retry state, then the POWER_GOOD signal is turned low.

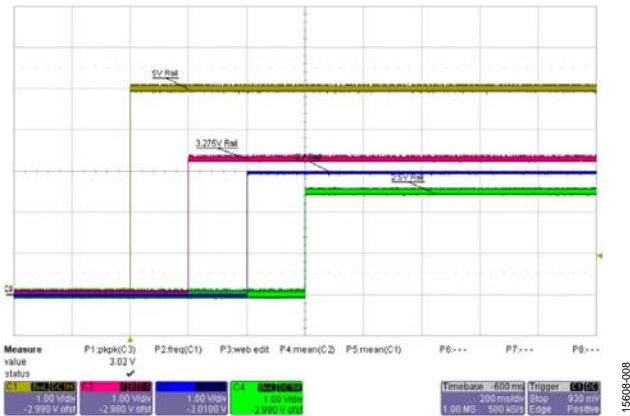

Figure 8. Sequence Up

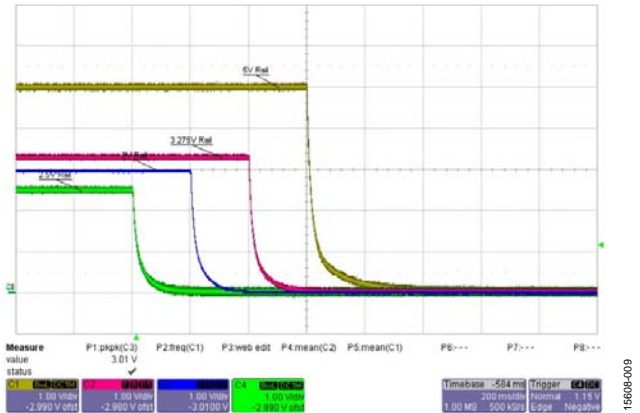

Figure 9. Sequence Down

FAULT HANDLING

The ADM1266-EVALZ board is preprogrammed to handle overvoltage, undervoltage, and timeout faults. If any undervoltage or timeout faults occur, the board sequences down and, as long as the ENABLE_L signal is low, the board automatically attempts to power up all the rails and reach the power-good state again. If an overvoltage fault occurs, all rails are immediately turned off. The ENABLE_L signal must be toggled to turn the sequence back up.

GPIO8 is connected to SW2 and is configured as the EXTERNAL_FAULT_L signal. If this signal goes high, then all rails are immediately turned off. Toggle SW2 to create an external fault. Additionally, turn the R1 or R10 potentiometers to create an overvoltage fault on the ADJ1 or ADJ2 rails.

GPIO5 is connected to LED2 and is configured as a fault signal. This signal is set up to be complimentary of the POWER_GOOD signal.

GPIO6 is connected to LED6 and is configured as a warning signal. The logic block section of the ADM1266 is used to logically OR all the overvoltage and undervoltage warning signals of all the rails and to drive the warning signal.

TELEMETRY AND BLACKBOX

Click the **Read Device(s) Status** icon (see Figure 10) to enable reading back of telemetry. If the icon is green, the GUI is actively reading back from the ADM1266. If the icon is red, the GUI is not reading from the ADM1266.

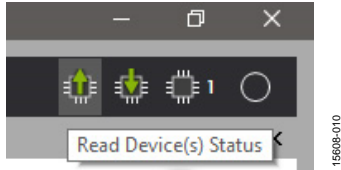

Figure 10. Read Device(s) Status Icon

Click **Monitor** and then **Rail Status** to view all the voltages and signal levels of the rails, as shown in Figure 11 and Figure 12.

Rails

Supply Name	Voltage	Status
12V Main	12.161v	OK
ADJ Rail 1	1.467v	OK
ADJ Rail 2	1.467v	OK
5V Rail	4.986v	OK
3.275V Rail	3.270v	OK
3V Rail	2.989v	OK
2.5V Rail	2.480v	OK

Figure 11. Rail Voltage Status View

Signals

Signal Name	Status
Power Good	High
Fault	Low
Warning	Low
Enable_L	Low
External Fault_L	Low

Figure 12. Rail Signal Status View

Click **Monitor** and then **Blackbox** to view the blackbox information. Click the **Read records from hardware** icon (see Figure 13) to read back blackbox information from the hardware.

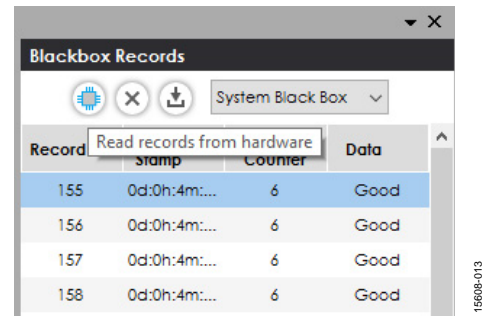

Figure 13. Read records from hardware Icon

The list of records shows all the blackbox records. Click any record to view detailed information.

The blackbox summary, along with the rails and signals status, identify the root cause of the fault. In the example shown in Figure 14, an overvoltage fault occurred on ADJ Rail 2 while the device was in the power-good state. Additional information, such as the time of fault and the previous states, can also be found in the summary.

Summary

Record ID: 169
 Record Time: 4/24/2018 2:32:34 PM
 Power Up: 10
 Trigger Source: Enable Blackbox[1] in "Power OK" state
 Previous State: 18 (ST_0.85V Rail 2)

Rails

Supply Name	Data
12V Main	OK
ADJ Rail 1	OK
ADJ Rail 2	OV Fault
5V Rail	OK
3.275V Rail	OK
3V Rail	OK
2.5V Rail	OK
2V Rail	OK
1.8V Rail	OK
1.5V Rail	OK

Figure 14. Blackbox Summary Example

MARGINING

The [ADM1266](#) Super Sequencer not only monitors each of the 16 outputs, but also margins nine outputs, either high or low. Margining operation moves a rail either up or down for testing purposes. Margining allows a system to be fully characterized over supply limits without the use of external hardware or resources.

The GUI provides an easy way to margin rails high or low.

Click Hardware Configure and then **Closed Loop Margining** to open the margining window. At the bottom right corner, you can select one option from the margin options shown in the drop-down combination box and click **Apply**. Additionally, you can click individual rails and set their margin options.

The pin status window shows the effect of the margin high or margin low operation. Figure 15 shows the rails going from a nominal setpoint to margin high, margin low, and back to a nominal voltage. The telemetry plot in the GUI is slow and does not capture the ramps to each of the voltage levels.



Figure 15. Rails Going from Nominal Setpoint to Margin High, Margin Low, and Back to Nominal Voltage

MULTIPLE BOARD SETUP

Connector JP5 and Connector JP6 allow up to 16 ADM1266-EVALZ boards to connect to evaluate complex cascade sequencing setups. The user must only connect the power and the [EVAL-ADP-I2C-USB](#) to one board.

For a two board setup, the user can configure the PMBus address by using the ADDR1 and ADDR2 jumpers on JP7. These jumpers set up Address 0x40 and Address 0x42, respectively. Alternatively, R55 or R56 can be modified to select a PMBus address. A two board configuration file can also be downloaded from the [ADM1266](#) product page. All the signals of the single-board configuration are the same, and an additional 16 rails are monitored on the second board. All of the previously described tests can be repeated on a two board setup.

EVALUATION BOARD SCHEMATICS AND ARTWORK

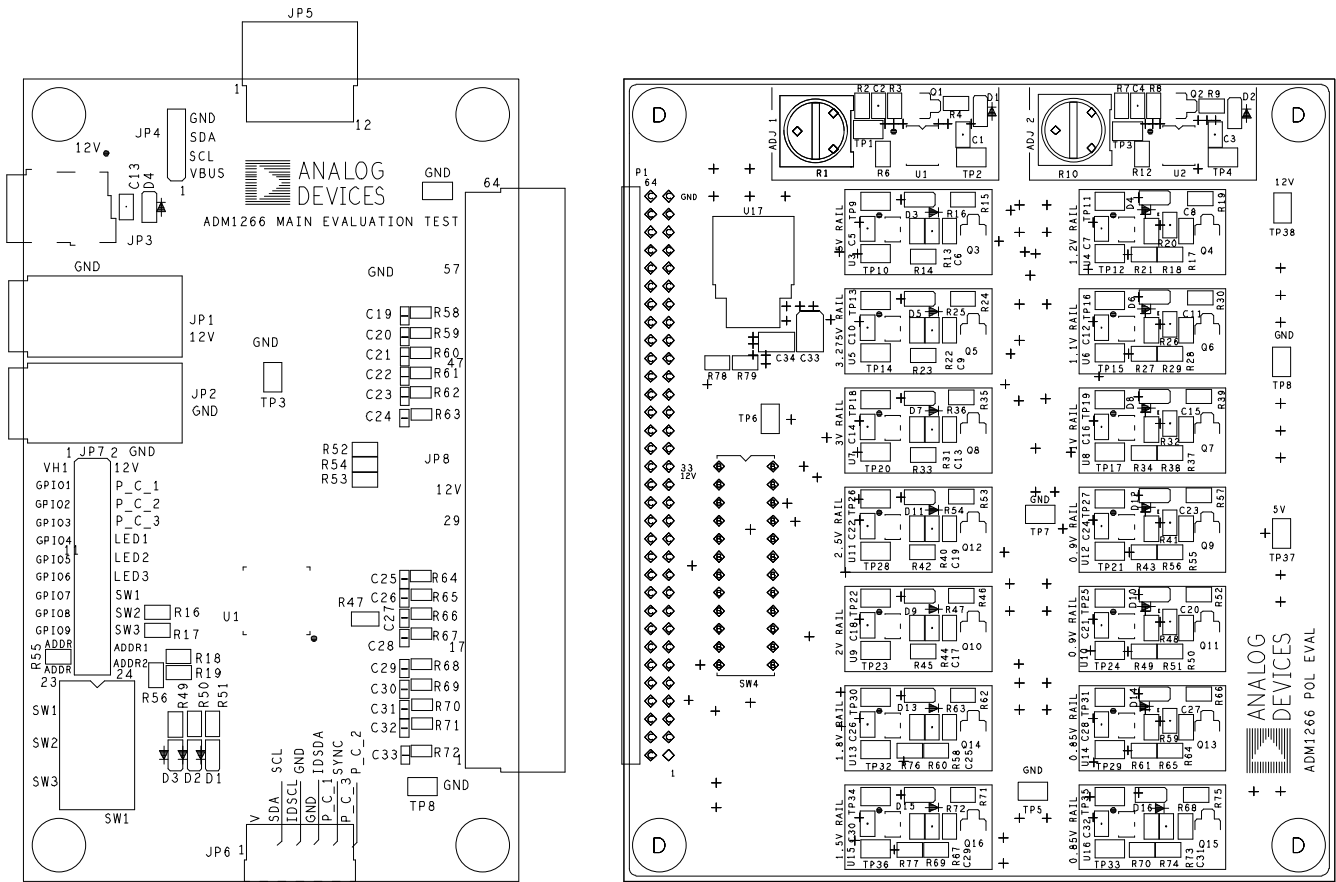
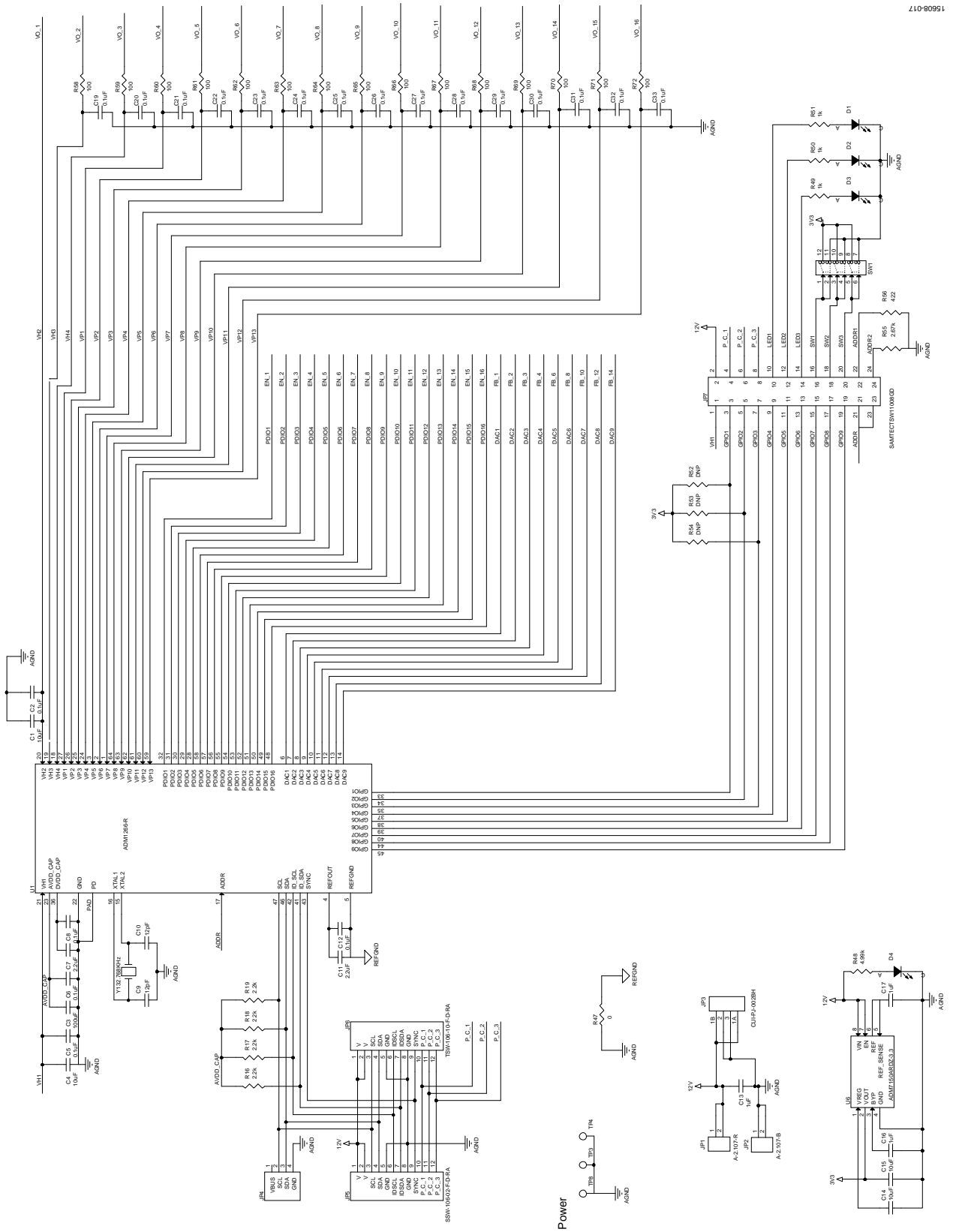

Figure 16. Top Silkscreen

MAIN EVALUATION BOARD SCHEMATICS



15609-017

Figure 17. Main Evaluation Board Schematic

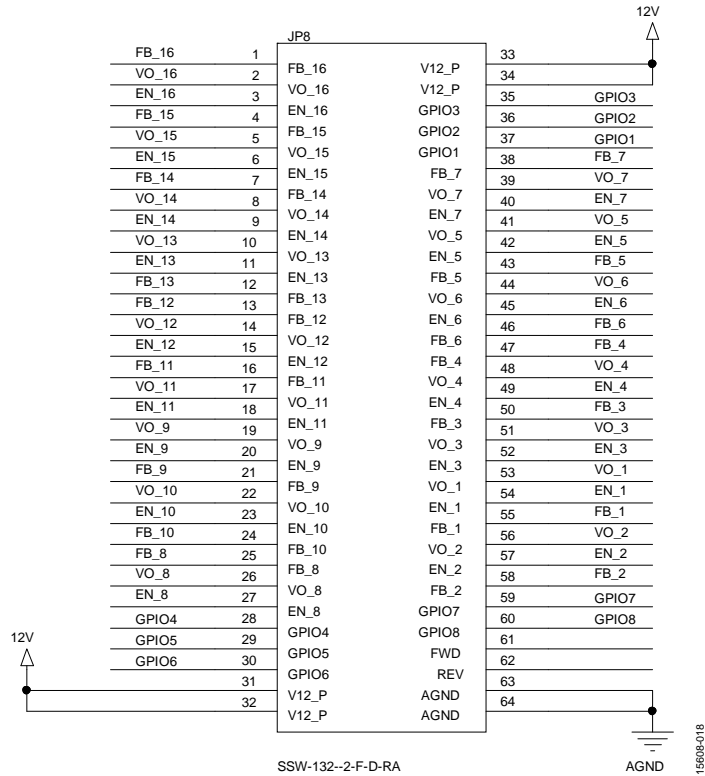

Figure 18. JP8 Connector on Main Evaluation Board

POL BOARD SCHEMATICS

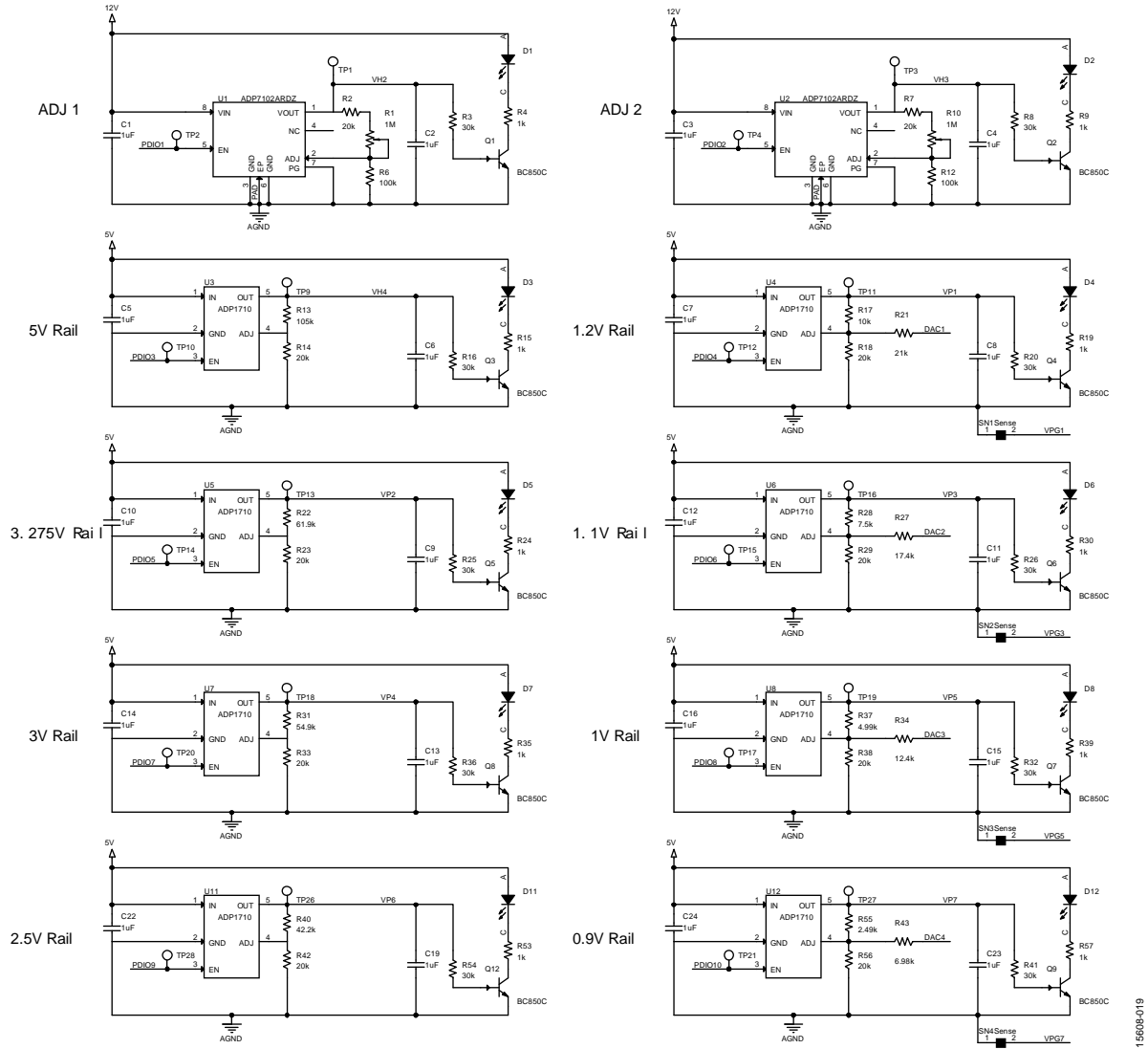

Figure 19. POL Board Schematic 1

15698-019

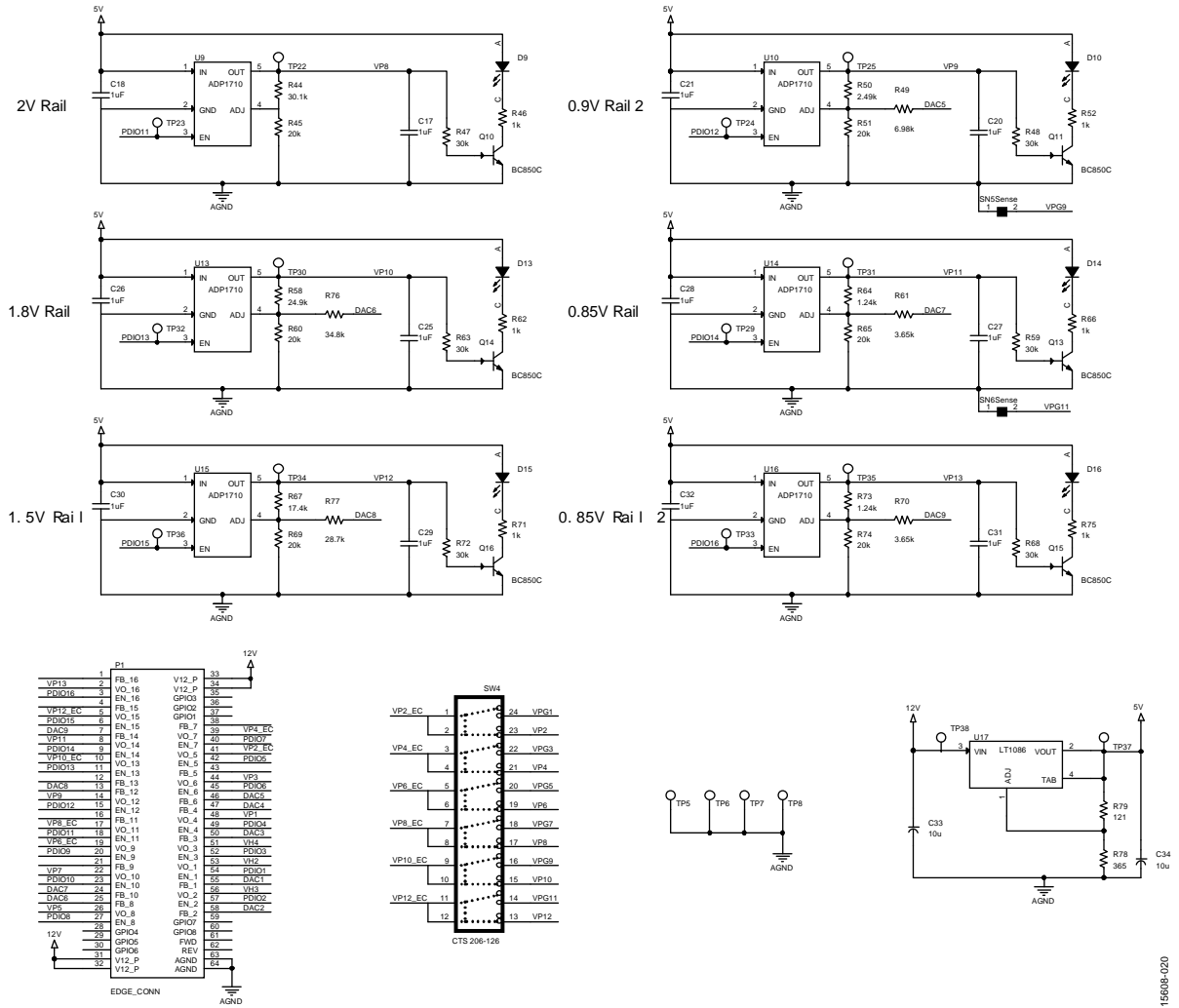

Figure 20. POL Board Schematic 2

18608-020

ORDERING INFORMATION

BILL OF MATERIALS

Table 4. Bill of Materials for the Main Evaluation Board

Reference Designator	Value	Description	Manufacturer	Part Number
C2, C5, C6, C8, C12	0.1 μ F	Multilayer ceramic capacitors (MLCCs), 0.1 μ F, 16 V to 25 V, X5R, 0402	Murata, T-Y	C0402
C19 to C33	0.1 μ F	MLCCs, 0.1 μ F, 16 V to 25 V, X5R, 0402	Murata, T-Y	C0402
C1, C4, C14, C15	10 μ F	MLCCs, 10 μ F, 16 V to 25 V, X5R, 0603	Murata/TDK	C0603
C3	100 μ F	MLCC, 100 μ F, 6.3 V, X5R, 0805	Murata	C0805
C7, C11	2.2 μ F	MLCCs, 2.2 μ F, 16 V to 25 V, X5R, 0603	Murata	C0603
C9, C10	12 pF	MLCCs, 12 pF, NPO, 50 V	Murata	C0603
C13, C16, C17	1 μ F	MLCCs, 1 μ F, 16 V to 25 V, X5R, 0603	Murata	C0603
D1, D2, D3, D4	LED, green	Green LEDs	Lumex, Kingbright	LED0805
JP4	4-pin	4-pin PMBus connector	FCI	CNBERG1X4H205LD36
JP3	2.5 mm \times 5.5 mm	Power connector jack, SMT	CUI INC	PJ-002BH-SMT-TR
JP1	A-2.107-R	PCB socket, red	Multicomp	CNMULTICOMP-A2107
JP2	A-2.107-B	PCB socket, black	Multicomp	CNMULTICOMP-A2107
JP5	2 pin \times 6 pin, female	10 female connector, double row-RA	Samtec	SSW-106-0X-X-D-RA
JP7	2 pin \times 12 pin	20-pin connector	Samtec	CNBERG2X10H330LD36
JP8	32-pin	32-pin edge connector, double row, RA	Samtec	CNSAMTEC-SSW-132-02-S-D-RA
JP6	2 pin \times 6 pin	10-pin connector, double row-RA	Samtec	CNSAMTECTSW-106-xx-F-D-RA
R56	422 Ω	Resistor	Vishay	R0603
R16, R17, R18, R19	2.21 k Ω	Resistors	Vishay	R0603
R48	4.99 k Ω	Resistor	Vishay	R0603
R49, R50, R51	1 k Ω	Resistors	Vishay	R0603
R47	0 k Ω	Resistor	Panasonic	R0805
R52, R53, R54	Not applicable	Resistors, do not insert	Not applicable	Not applicable
R55	2.67 k Ω	Resistor	Vishay	R0603
R58 to R72	100 Ω	Resistors	Vishay, Panasonic	R0402
SW1	PSON	SPDT switch, gold, 50 V	CTS	SWDIP12H335
TP3, TP4, TP8	A-02	Test points	3M	TSPM70X135
U1	ADM1266	Cascadable Super Sequencer with margin control and fault recording	Analog Devices	ADM1266
U6	ADM7150ARDZ-3.3	800 mA ultralow noise, high PSRR, RF linear regulator	Analog Devices	ADM7150ARDZ-3.3
Y1	32.768 kHz	Crystal	Epson	FC-135 32.7680KA-AC

Table 5. Bill of Materials for the POL Evaluation Board

Reference Designator	Value	Description	Manufacturer	Part Number
C1, C2, C3, C4, C5, C6, C7, C8, C9, C10, C11, C12, C13, C14, C15, C16, C17, C18, C19, C20, C21, C22, C23, C24, C25, C26, C27, C28, C29, C30, C31, C32	1 μ F	Ceramic capacitors, 25 V, X7R, 0603	T-Y	TMK107B7105MA-T
C33, C34	10 μ F	Tantalum capacitors, 16 V, 10%, 1206	Kemet	T491A106K016AT, 293D106X9016A2TE3
D1, D2, D3, D4, D5, D6, D7, D8, D9, D10, D11, D12, D13, D14, D15, D16	0805, 574 nm	LEDs, super green SMT	Lumex	SML-LX0805SUGC-TR
P1	Edge connector	32-pin edge connector, double row	Samtec	TSW-132-08-G-D-RA
Q1, Q2, Q3, Q4, Q5, Q6, Q7, Q8, Q9, Q10, Q11, Q12, Q13, Q14, Q15, Q16	45 V, 0.1 A	NPN transistors, SOT-23	Nexperia	BC850C, 215
R1, R10	1 M Ω	Trimmers, 0.5 W, PC pin	Bourns Inc.	3386F-1-105TLF
R2, R7, R14, R18, R23, R29, R33, R38, R42, R45, R51, R56, R60, R65, R69, R74	20 k Ω	SMD resistors, 1%, 1/4 W, 0603	Vishay or equivalent	CRCW060320K0FKEA, ERJ-3EKF2002V
R3, R8, R16, R20, R25, R26, R32, R36, R41, R47, R48, R54, R59, R63, R68, R72, R44	30.1 k Ω	SMD resistors, 1%, 1/4 W 060	Vishay or equivalent	CRCW060330K1FKEA
R4, R9, R15, R19, R24, R30, R35, R39, R46, R52, R53, R57, R62, R66, R71, R75	1 k Ω	SMD resistors, 1%, 1/4 W, 0603	Vishay or equivalent	CRCW06031K00FKEA
R6, R12	100 k Ω	SMD resistors, 1%, 1/4 W, 0603	Vishay or equivalent	CRCW0603100KFKEA
R13	105 k Ω	SMD resistor, 1%, 1/4 W, 0603	Vishay or equivalent	CRCW0603105KFKEA
R17	10 k Ω	SMD resistor, 1%, 1/4 W, 0603	Vishay or equivalent	CRCW060310K0FKEA
R21	21 k Ω	SMD resistor, 1%, 1/4 W, 0603	Vishay or equivalent	CRCW060321K0FKEA
R22	61.9 k Ω	SMD resistor, 1%, 1/4 W, 0603	Vishay or equivalent	CRCW060361K9FKEA
R27, R67	17.4 k Ω	SMD resistors, 1%, 1/4 W, 0603	Vishay or equivalent	CRCW060317K4FKEA
R28	7.5 k Ω	SMD resistor, 1%, 1/4 W, 0603	Vishay or equivalent	CRCW06037K50FKEA
R31	54.9 k Ω	SMD resistor, 1%, 1/4 W, 0603	Vishay or equivalent	CRCW060354K9FKEA
R34	12.4 k Ω	SMD resistor, 1%, 1/4 W, 0603	Vishay or equivalent	CRCW060312K4FKEA
R37	4.99 k Ω	SMD resistor, 1%, 1/4 W, 0603	Vishay or equivalent	CRCW06034K99FKEA
R40	42.2 k Ω	SMD resistor, 1%, 1/4 W, 0603	Vishay or equivalent	CRCW060342K2FKEA
R43, R49	6.98 k Ω	SMD resistors, 1%, 1/4 W, 0603	Vishay or equivalent	CRCW06036K98FKEA, ERJ-3EKF6981V
R50, R55	2.49 k Ω	SMD resistors, 1%, 1/4 W, 0603	Vishay or equivalent	CRCW06032K49FKEA
R58	24.9 k Ω	SMD resistor, 1%, 1/4 W, 0603	Vishay or equivalent	CRCW060324K9FKEA
R61, R70	3.65 k Ω	SMD resistors, 1%, 1/4 W, 0603	Vishay or equivalent	CRCW06033K65FKEA
R64, R73	1.24 k Ω	SMD resistors, 1%, 1/4 W, 0603	Vishay or equivalent	CRCW06031K24FKEA
R76	34.8 k Ω	SMD resistor, 1%, 1/4 W, 0603	Vishay or equivalent	CRCW060334K8FKEA
R77	28.7 k Ω	SMD resistor, 1%, 1/4 W, 0603	Vishay or equivalent	CRCW060328K7FKEA
R78	365 Ω	SMD resistor, 1%, 1/4 W, 0604	Vishay or equivalent	CRCW0603365RFKEA
R79	121 Ω	SMD resistor, 1%, 1/4 W, 0605	Vishay or equivalent	CRCW0603121RFKEA
SW4	50 mA, 24 V	Switch slide DIP SPDT	CT Select	CTS 206-126

Reference Designator	Value	Description	Manufacturer	Part Number
TP1, TP2, TP3, TP4, TP5, TP6, TP7, TP8, TP9, TP10, TP11, TP12, TP13, TP14, TP15, TP16, TP17, TP18, TP19, TP20, TP21, TP22, TP23, TP24, TP25, TP26, TP27, TP28, TP29, TP30, TP31, TP32, TP33, TP34, TP35, TP36, TP37, TP38	A-02	PC test points, mini SMD	3M	5019
U1, U2	ADP7102ARDZ	20 V, 300 mA, low noise, CMOS LDOs	Analog Devices	ADP7102ARDZ-R7
U3, U4, U5, U6, U7, U8, U9, U10, U11, U12, U13, U14, U15, U16	ADP1710- AUJZR7	150 mA, low dropout, CMOS linear regulators	Analog Devices	ADP1710AUJZ-R7
U17	LT1086	1.5A low dropout, positive regulators	Analog Devices	LT1086CM#PBF

**ESD Caution**

ESD (electrostatic discharge) sensitive device. Charged devices and circuit boards can discharge without detection. Although this product features patented or proprietary protection circuitry, damage may occur on devices subjected to high energy ESD. Therefore, proper ESD precautions should be taken to avoid performance degradation or loss of functionality.

Legal Terms and Conditions

By using the evaluation board discussed herein (together with any tools, components documentation or support materials, the "Evaluation Board"), you are agreeing to be bound by the terms and conditions set forth below ("Agreement") unless you have purchased the Evaluation Board, in which case the Analog Devices Standard Terms and Conditions of Sale shall govern. Do not use the Evaluation Board until you have read and agreed to the Agreement. Your use of the Evaluation Board shall signify your acceptance of the Agreement. This Agreement is made by and between you ("Customer") and Analog Devices, Inc. ("ADI"), with its principal place of business at One Technology Way, Norwood, MA 02062, USA. Subject to the terms and conditions of the Agreement, ADI hereby grants to Customer a free, limited, personal, temporary, non-exclusive, non-sublicensable, non-transferable license to use the Evaluation Board FOR EVALUATION PURPOSES ONLY. Customer understands and agrees that the Evaluation Board is provided for the sole and exclusive purpose referenced above, and agrees not to use the Evaluation Board for any other purpose. Furthermore, the license granted is expressly made subject to the following additional limitations: Customer shall not (i) rent, lease, display, sell, transfer, assign, sublicense, or distribute the Evaluation Board; and (ii) permit any Third Party to access the Evaluation Board. As used herein, the term "Third Party" includes any entity other than ADI, Customer, their employees, affiliates and in-house consultants. The Evaluation Board is NOT sold to Customer; all rights not expressly granted herein, including ownership of the Evaluation Board, are reserved by ADI. CONFIDENTIALITY. This Agreement and the Evaluation Board shall all be considered the confidential and proprietary information of ADI. Customer may not disclose or transfer any portion of the Evaluation Board to any other party for any reason. Upon discontinuation of use of the Evaluation Board or termination of this Agreement, Customer agrees to promptly return the Evaluation Board to ADI. ADDITIONAL RESTRICTIONS. Customer may not disassemble, decompile or reverse engineer chips on the Evaluation Board. Customer shall inform ADI of any occurred damages or any modifications or alterations it makes to the Evaluation Board, including but not limited to soldering or any other activity that affects the material content of the Evaluation Board. Modifications to the Evaluation Board must comply with applicable law, including but not limited to the RoHS Directive. TERMINATION. ADI may terminate this Agreement at any time upon giving written notice to Customer. Customer agrees to return to ADI the Evaluation Board at that time. LIMITATION OF LIABILITY. THE EVALUATION BOARD PROVIDED HEREUNDER IS PROVIDED "AS IS" AND ADI MAKES NO WARRANTIES OR REPRESENTATIONS OF ANY KIND WITH RESPECT TO IT. ADI SPECIFICALLY DISCLAIMS ANY REPRESENTATIONS, ENDORSEMENTS, GUARANTEES, OR WARRANTIES, EXPRESS OR IMPLIED, RELATED TO THE EVALUATION BOARD INCLUDING, BUT NOT LIMITED TO, THE IMPLIED WARRANTY OF MERCHANTABILITY, TITLE, FITNESS FOR A PARTICULAR PURPOSE OR NON-INFRINGEMENT OF INTELLECTUAL PROPERTY RIGHTS. IN NO EVENT WILL ADI AND ITS LICENSORS BE LIABLE FOR ANY INCIDENTAL, SPECIAL, INDIRECT, OR CONSEQUENTIAL DAMAGES RESULTING FROM CUSTOMER'S POSSESSION OR USE OF THE EVALUATION BOARD, INCLUDING BUT NOT LIMITED TO LOST PROFITS, DELAY COSTS, LABOR COSTS OR LOSS OF GOODWILL. ADI'S TOTAL LIABILITY FROM ANY AND ALL CAUSES SHALL BE LIMITED TO THE AMOUNT OF ONE HUNDRED US DOLLARS (\$100.00). EXPORT. Customer agrees that it will not directly or indirectly export the Evaluation Board to another country, and that it will comply with all applicable United States federal laws and regulations relating to exports. GOVERNING LAW. This Agreement shall be governed by and construed in accordance with the substantive laws of the Commonwealth of Massachusetts (excluding conflict of law rules). Any legal action regarding this Agreement will be heard in the state or federal courts having jurisdiction in Suffolk County, Massachusetts, and Customer hereby submits to the personal jurisdiction and venue of such courts. The United Nations Convention on Contracts for the International Sale of Goods shall not apply to this Agreement and is expressly disclaimed.