

SPECIFICATION

Part No. : **TLS.01.305111**

Description : Shockwave 698-960/1575.42/1710-2700MHz
Permanent Mount External Antenna
3M CFD-200 SMA(M)

Features : Applicable for 2G/3G/4G cellular bands and GPS
Over 45% efficiency and 2.2 dBi gain
Mechanically robust for indoor/outdoor applications
Height: 79.45mm (3.13"); Diameter: 42mm (1.65")
IP67 and IP69K Waterproof
Low loss CFD-200 cable, 3 meters
SMA(M) connector
RoHS compliant



1. Introduction

The Shockwave TLS.01.305111 is a permanent mount, waterproof, external 2G/3G/4G cellular and GPS antenna operating at 698-960/1575.42/1710-2700MHz with an N type male connector. It has been designed to be used on a Ground Plane. It can be used in mobile and fixed applications for 4G LTE wireless such as :

- Public safety
- HD Video Streaming
- Utilities and Smart Cities
- Fleet Management
- Agricultural
- Industrial

This antenna has superior performance over wide-bands compared to traditional whip antennas. Up to 77% efficiency and with a minimum 2.2dBi peak gain over all cellular bands result when mounted on a 30x30 cm ground plane. Stable radiation patterns over low angles provides consistent gain in the horizontal plane, meaning that it is especially suitable for cellular applications.

A unique indent tab on the base of the antenna allows a wrench to be used to solidly lock the antenna on top of its mounting location while tightening up the nut beneath the metal panel. Waterproof O-rings around the bottom base prevent water from leaking under the antenna.

The TLS.01 antenna is IP67 waterproof and IP69K resistant against high pressure water jets in commercial cleaning environments, which makes the antenna ideal for 2G/3G/4G applications either in indoor or in harsh outdoor environments.

2. Specification

ELECTRICAL								
Operation Band	LTE	GSM850	GSM900	GPS	DCS	PCS	WCDMA I	LTE
Operation Frequency (MHz)	698~806	824~896	880~960	1575.42	1710~1880	1850~1990	1920~2170	2300~2690
On 30 x 30 cm ground plane								
Efficiency (%)								
30cm Cable Length	94.23	95.11	80.92	67.29	77.21	80.27	78.56	67.79
1m Cable Length	89.16	90.83	77.28	62.80	70.42	73.21	72.37	61.82
2m Cable Length	83.21	83.50	70.48	55.97	62.76	64.59	63.50	53.51
3m Cable Length	77.02	77.31	65.31	51.04	55.77	57.19	56.04	46.50
5m Cable Length	66.52	65.80	55.17	42.46	44.05	44.84	43.61	35.10
Peak Gain (dBi)								
30cm Cable Length	3.22	3.32	3.15	2.08	3.90	3.82	3.73	4.64
1m Cable Length	3.02	3.12	2.95	1.78	3.50	3.42	3.33	4.24
2m Cable Length	2.72	2.82	2.55	1.28	3.00	2.92	2.73	3.64
3m Cable Length	2.42	2.42	2.25	0.88	2.50	2.32	2.23	3.02
5m Cable Length	1.72	1.72	1.55	0.08	1.50	1.32	1.13	1.82
Average Gain (dBi)								
30cm Cable Length	-0.26	-0.22	-0.93	-1.72	-1.13	-0.96	-1.05	-1.71
1m Cable Length	-0.50	-0.42	-1.13	-2.02	-1.53	-1.36	-1.41	-2.11
2m Cable Length	-0.80	-0.79	-1.53	-2.52	-2.03	-1.90	-1.98	-2.74
3m Cable Length	-1.14	-1.12	-1.86	-2.92	-2.54	-2.43	-2.52	-3.35
5m Cable Length	-1.77	-1.82	-2.59	-3.72	-3.57	-3.49	-3.61	-4.58
Return Loss (dB)*	<-8	<-10	<-10	<-10	<-10	<-10	<-10	<-10
Impedance	50 Ω							
Polarization	Vertical							
Radiation Property	Omni-Directional							
Max Input Power	100 W							

MECHANICAL	
Dimension (mm)	Height: 79.45mm(3.13") ; Diameter : 42mm(1.65")
Cable	3 meter CFD-200
Connector	SMA(M)
Material	Housing : UV Resistant ABS , Base : Nickel Plated Zinc Alloy
Weight (g)	270
Rec. Torque for Mounting	4.018 N.m
Max. Torque for Mounting	9.8 N.m
ENVIRONMENTAL	
Waterproof Rating	IP67 and IP69K
Operation Temperature	-40°C to 85°C
Humidity	Non-condensing 65°C 95% RH

*The data was measured with 3 meters cable length on a 30cm * 30cm ground plane.

LTE BANDS			
Band Number	LTE / LTE-Advanced / WCDMA / HSPA / HSPA+ / TD-SCDMA		
	Uplink	Downlink	Covered
1	UL: 1920 to 1980	DL: 2110 to 2170	✓
2	UL: 1850 to 1910	DL: 1930 to 1990	✓
3	UL: 1710 to 1785	DL: 1805 to 1880	✓
4	UL: 1710 to 1755	DL: 2110 to 2155	✓
5	UL: 824 to 849	DL: 869 to 894	✓
7	UL: 2500 to 2570	DL: 2620 to 2690	✓
8	UL: 880 to 915	DL: 925 to 960	✓
9	UL: 1749.9 to 1784.9	DL: 1844.9 to 1879.9	✓
11	UL: 1427.9 to 1447.9	DL: 1475.9 to 1495.9	✓
12	UL: 699 to 716	DL: 729 to 746	✓
13	UL: 777 to 787	DL: 746 to 756	✓
14	UL: 788 to 798	DL: 758 to 768	✓
17	UL: 704 to 716	DL: 734 to 746 (LTE only)	✓
18	UL: 815 to 830	DL: 860 to 875 (LTE only)	✓
19	UL: 830 to 845	DL: 875 to 890	✓
20	UL: 832 to 862	DL: 791 to 821	✓
21	UL: 1447.9 to 1462.9	DL: 1495.9 to 1510.9	✓
22	UL: 3410 to 3490	DL: 3510 to 3590	✗
23	UL: 2000 to 2020	DL: 2180 to 2200 (LTE only)	✓
24	UL: 1625.5 to 1660.5	DL: 1525 to 1559 (LTE only)	✓
25	UL: 1850 to 1915	DL: 1930 to 1995	✓
26	UL: 814 to 849	DL: 859 to 894	✓
27	UL: 807 to 824	DL: 852 to 869 (LTE only)	✓
28	UL: 703 to 748	DL: 758 to 803 (LTE only)	✓
29	UL: -	DL: 717 to 728 (LTE only)	✓
30	UL: 2305 to 2315	DL: 2350 to 2360 (LTE only)	✓
31	UL: 452.5 to 457.5	DL: 462.5 to 467.5 (LTE only)	✗
32	UL: -	DL: 1452 - 1496	✓
35		1850 to 1910	✓
38		2570 to 2620	✓
39		1880 to 1920	✓
40		2300 to 2400	✓
41		2496 to 2690	✓
42		3400 to 3600	✗
43		3600 to 3800	✗

3. Antenna Characteristics

3.1. Return Loss

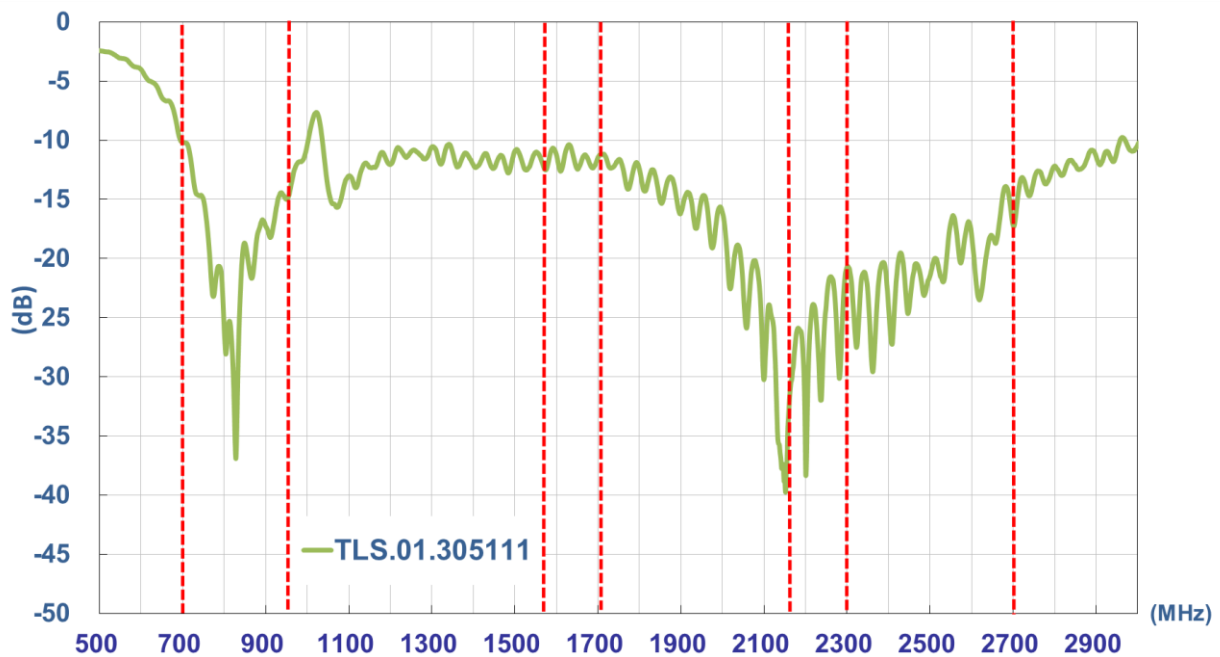

3.2. Efficiency

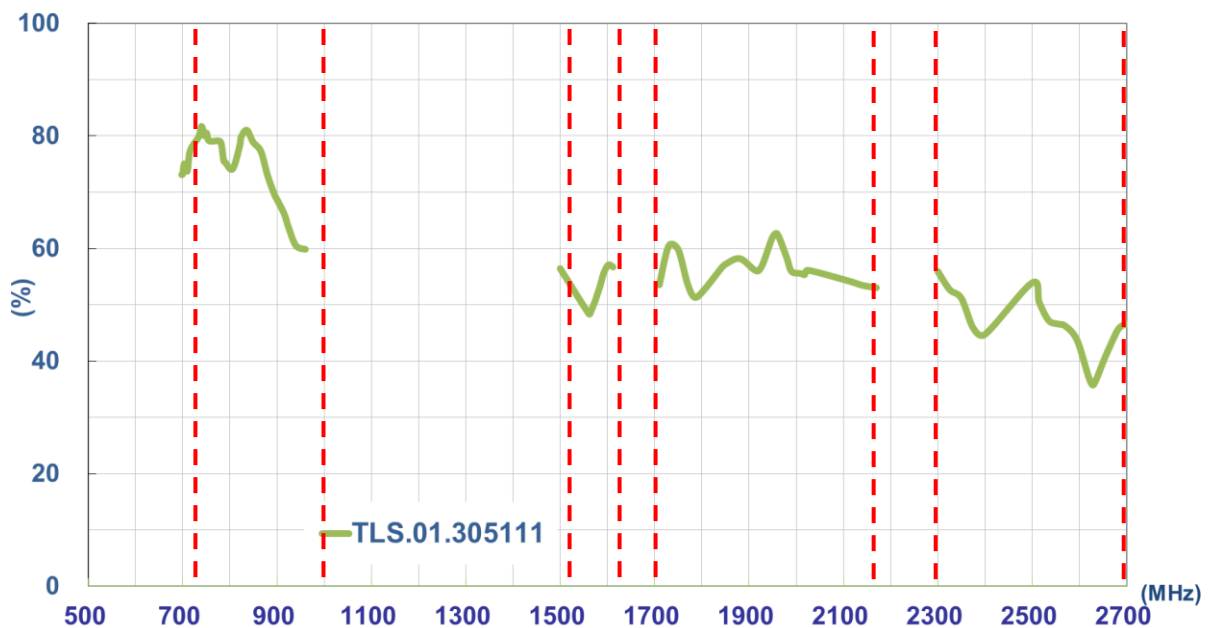

3.3. Average Gain

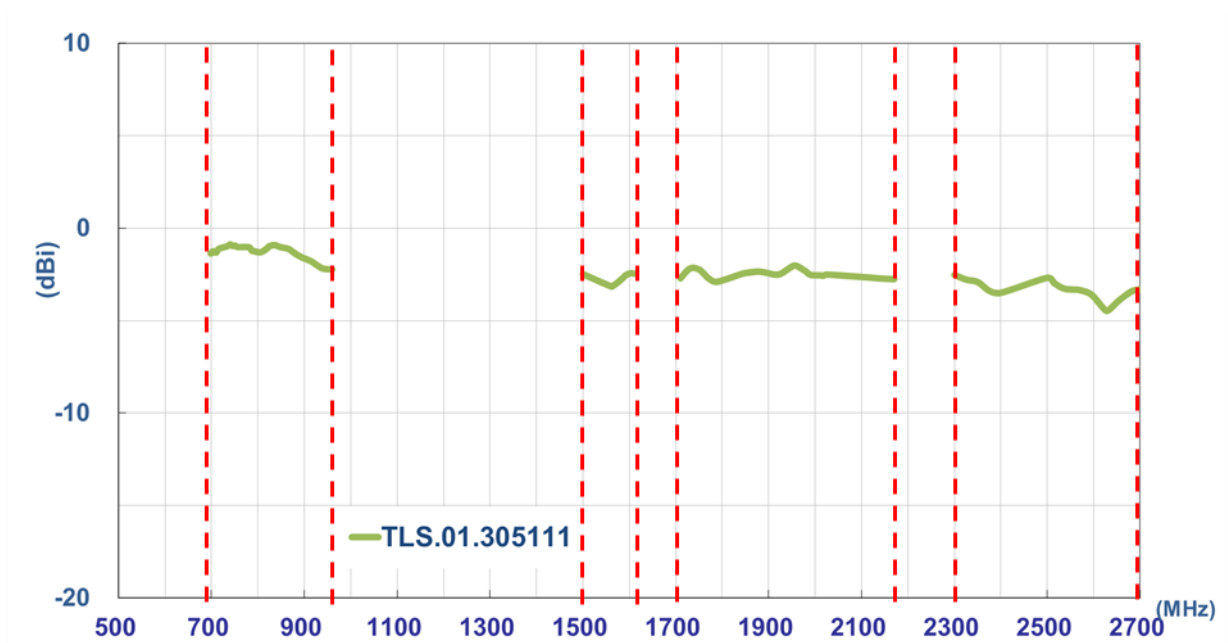

3.4. Peak Gain

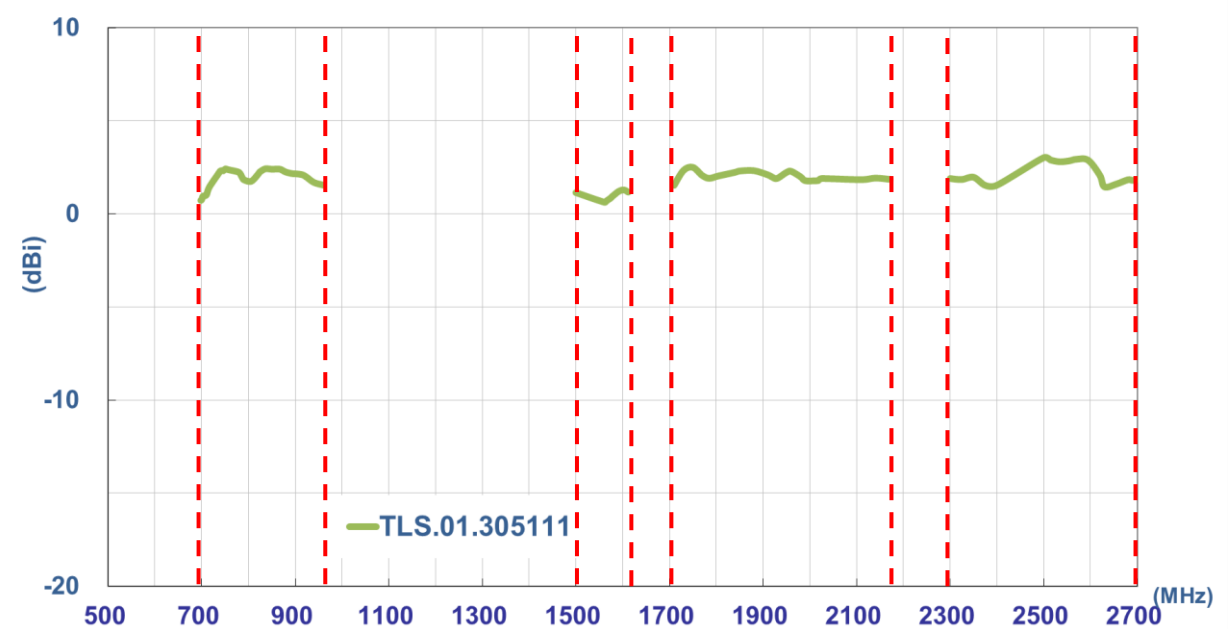

4. Antenna Radiation Pattern

4.1. Measurement Setup

The TLS.01 antenna is tested in a CTIA certified ETS-Lindgren Anechoic Chamber. The test setup is shown below.

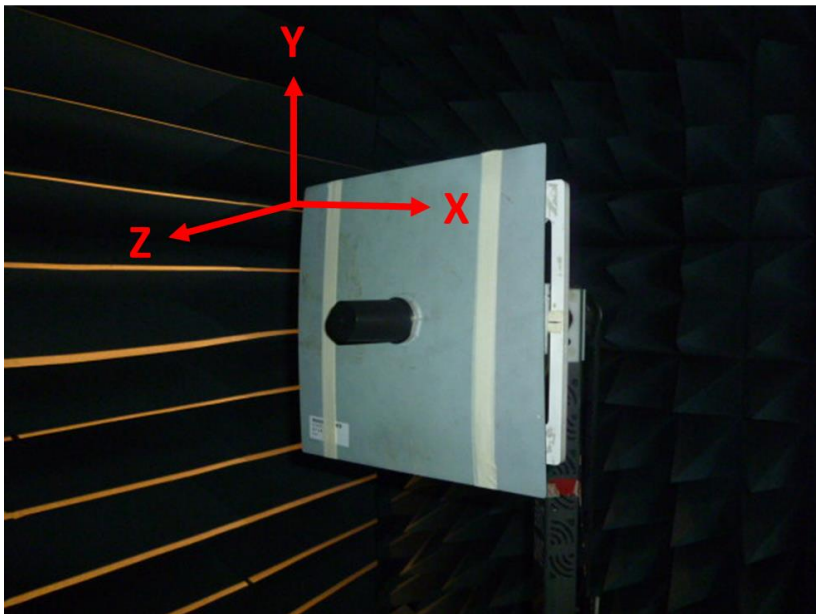

4.2. 2D Radiation Pattern

698-960MHz

XY Plane

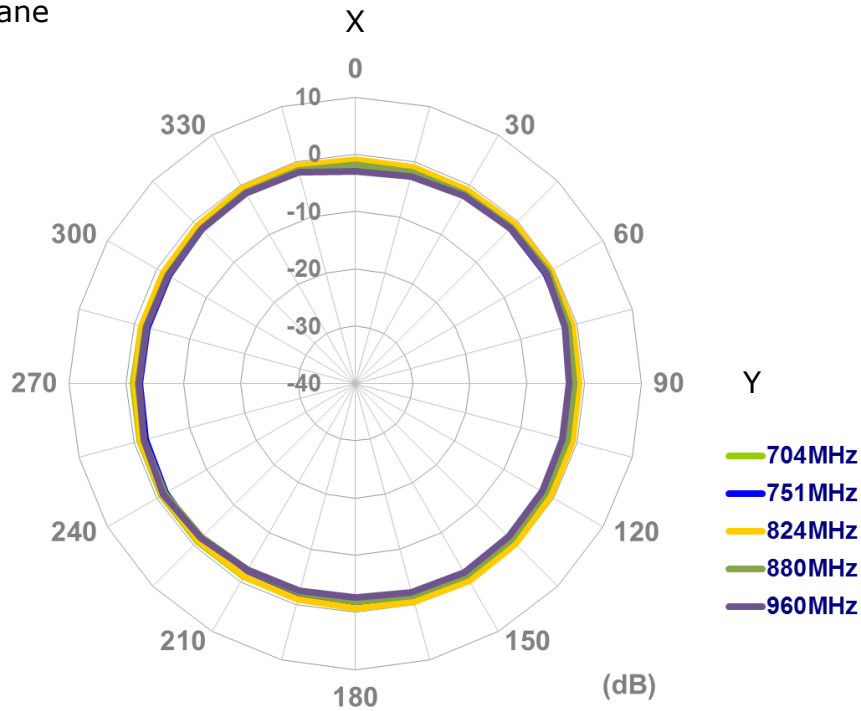

XZ Plane

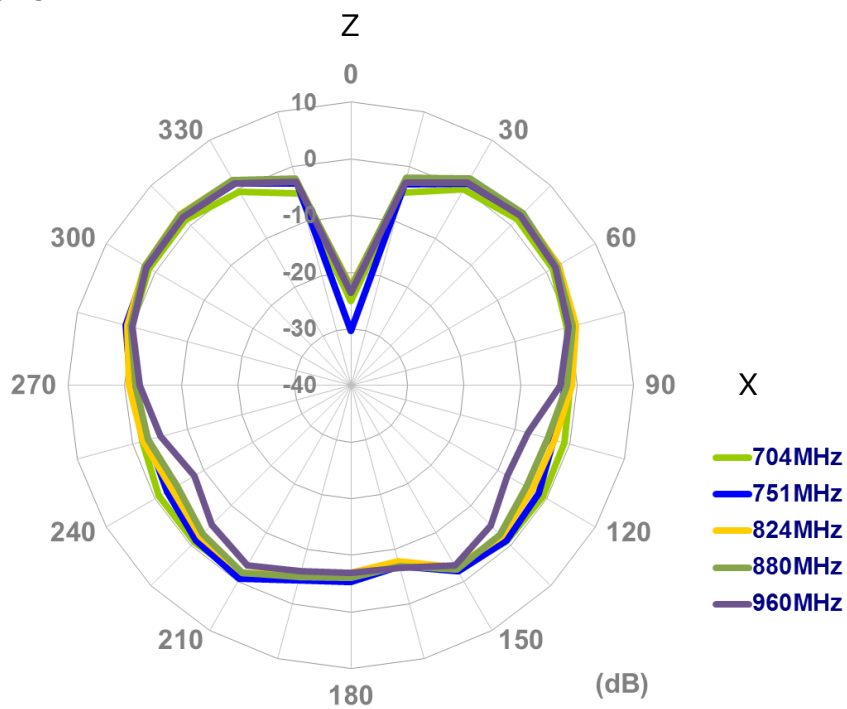

YZ Plane

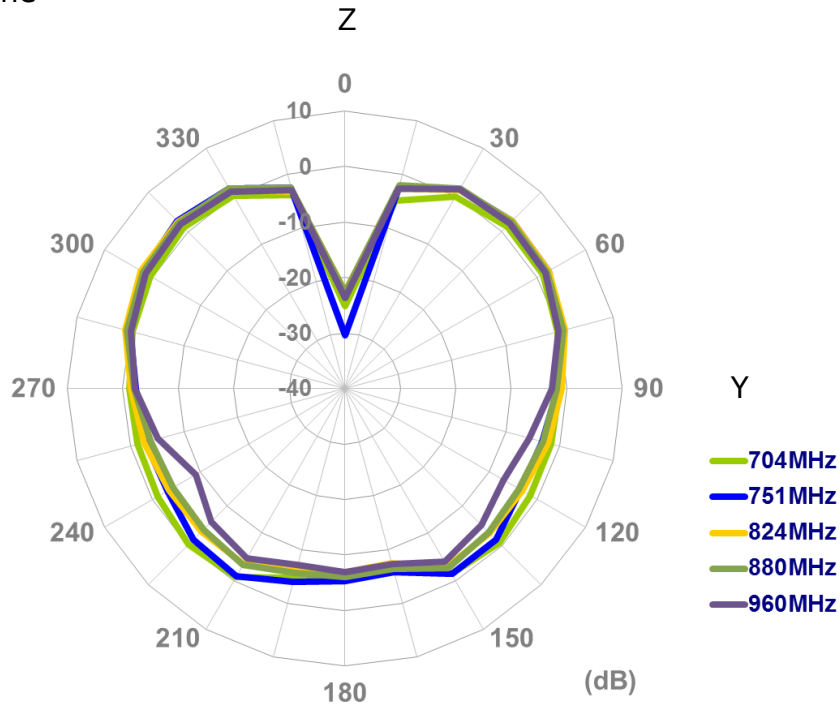

1575.42MHz

XY Plane

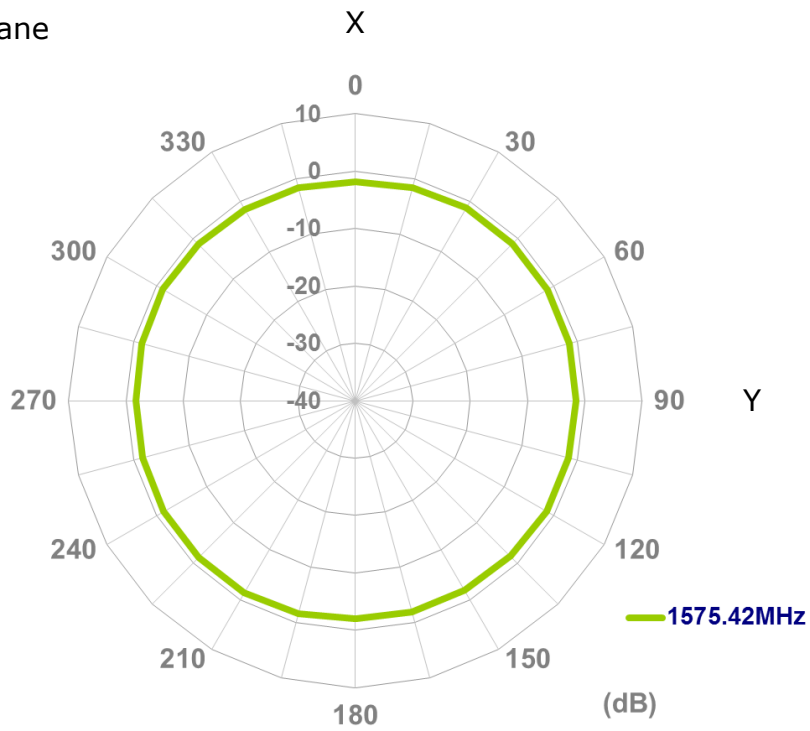

XZ Plane

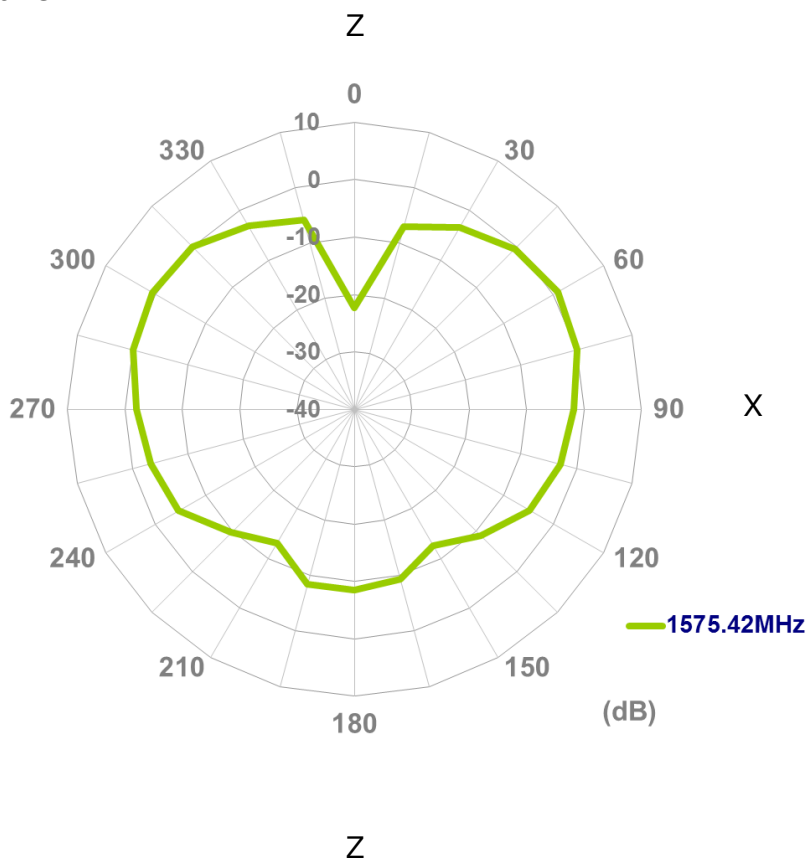



YZ Plane

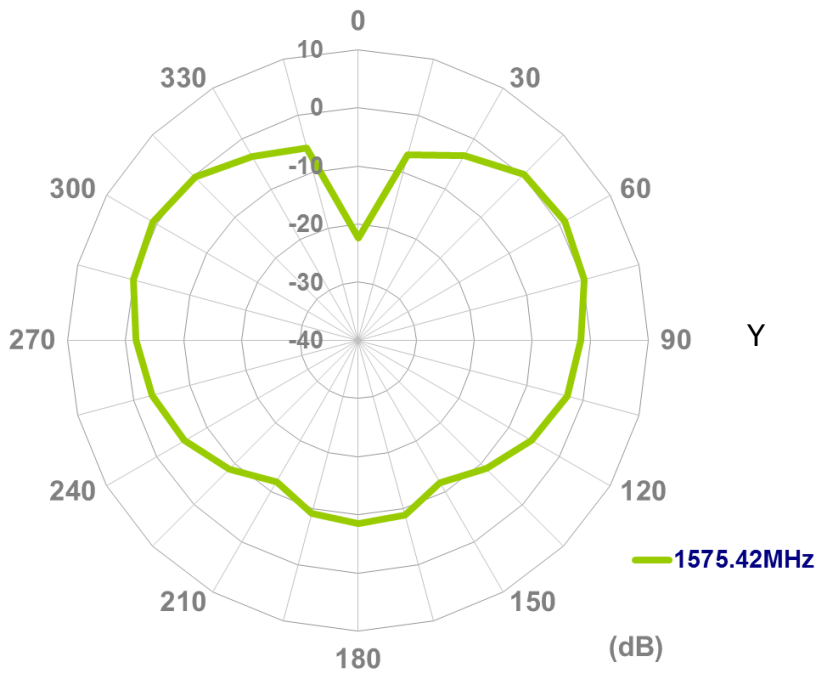

1710-2170MHz

XY Plane

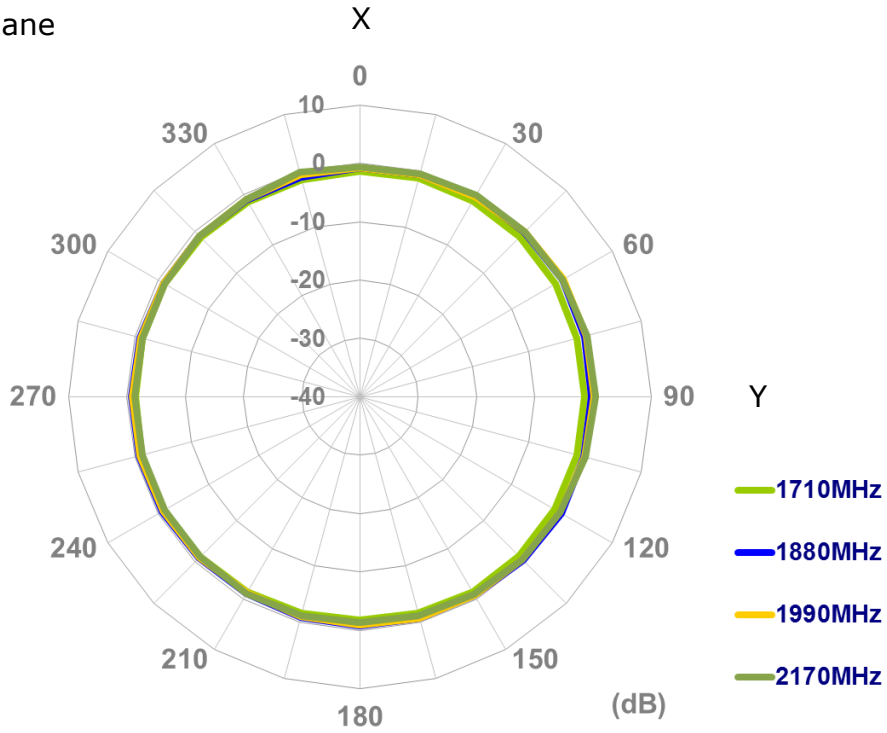

XZ Plane

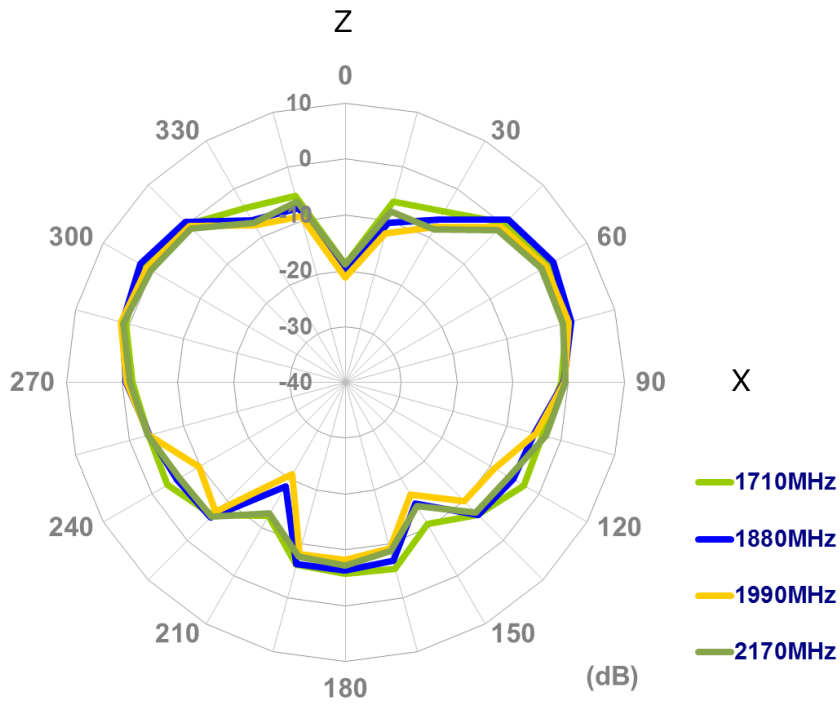

YZ Plane

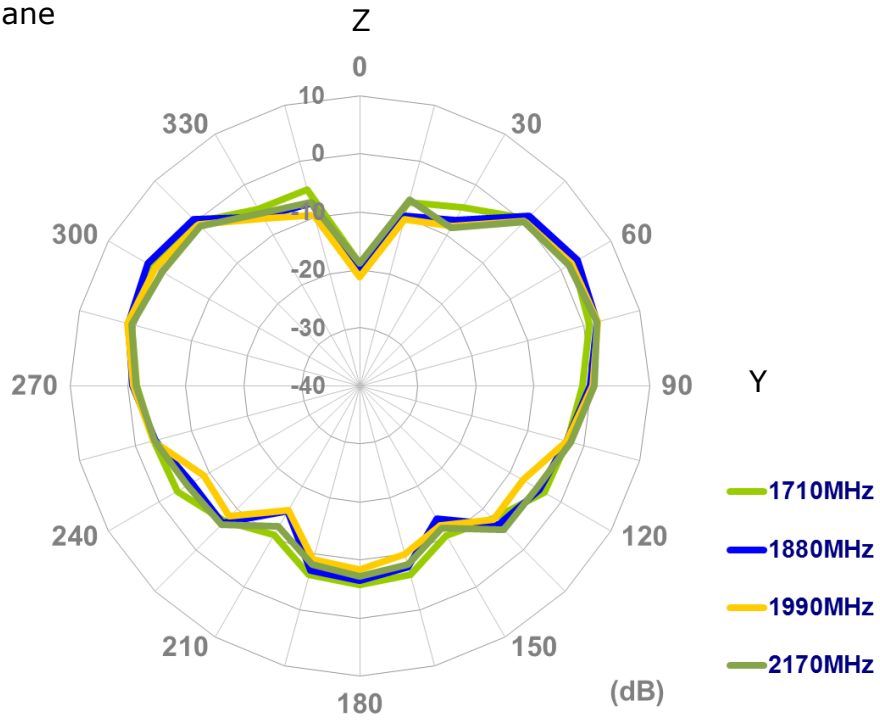

2300-2700MHz

XY Plane

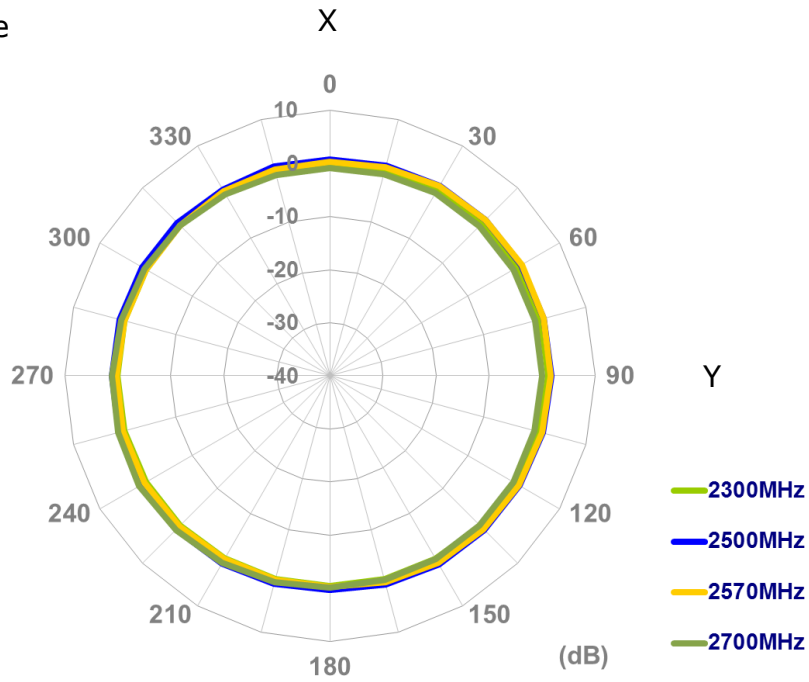

XZ Plane

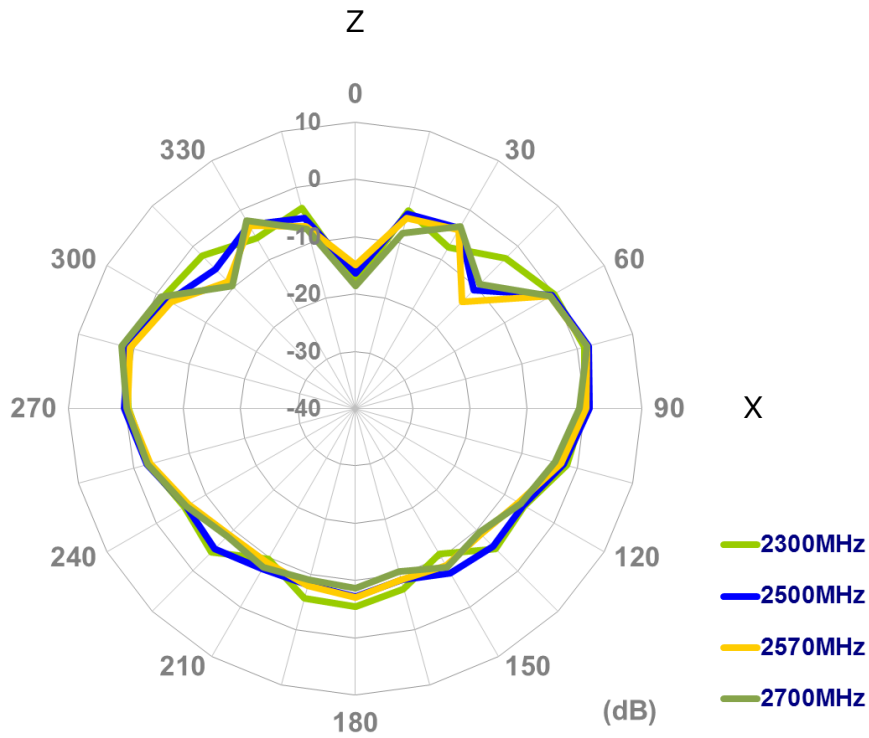



YZ Plane

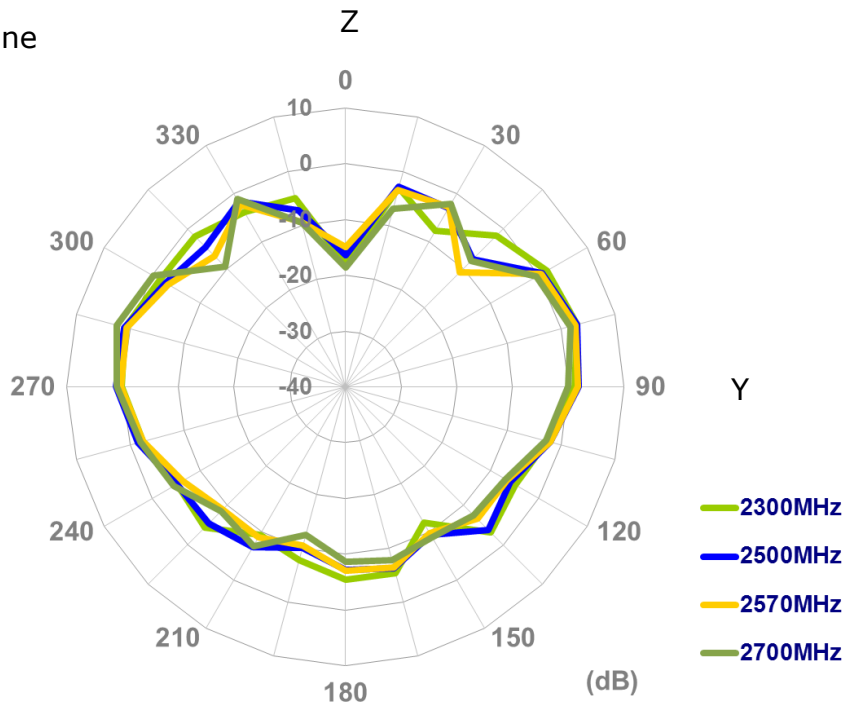

4.3. 3D Radiation Pattern

@751 MHz

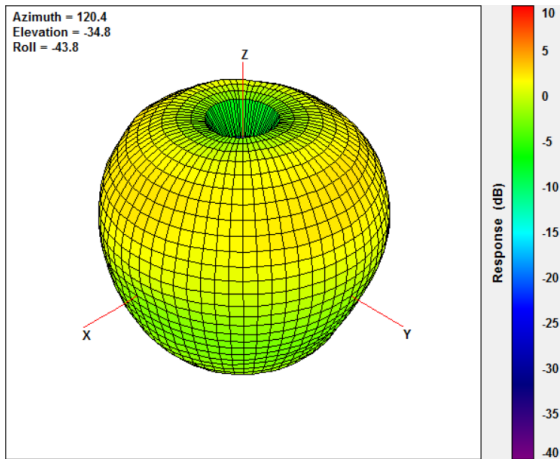

@824 MHz

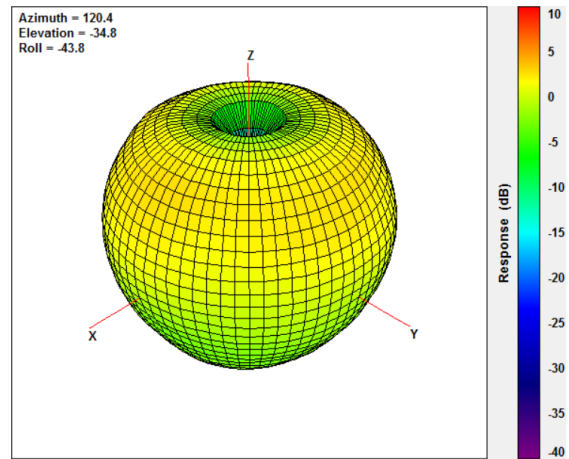

@880 MHz

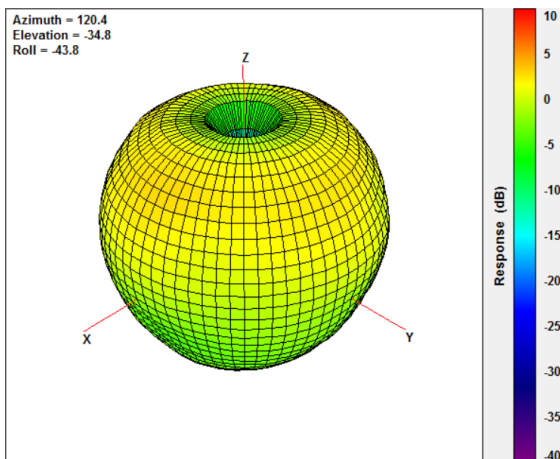

@960 MHz

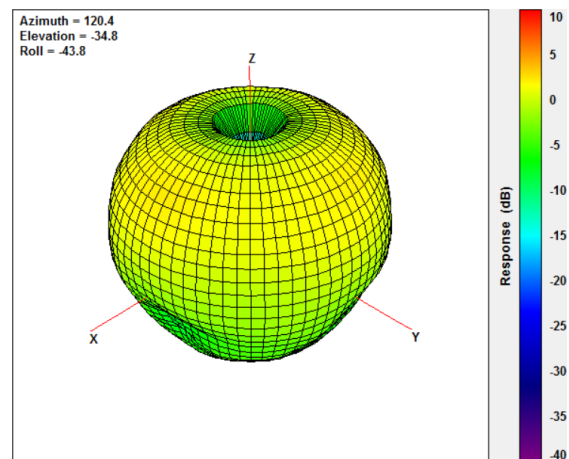

@1575.42 MHz

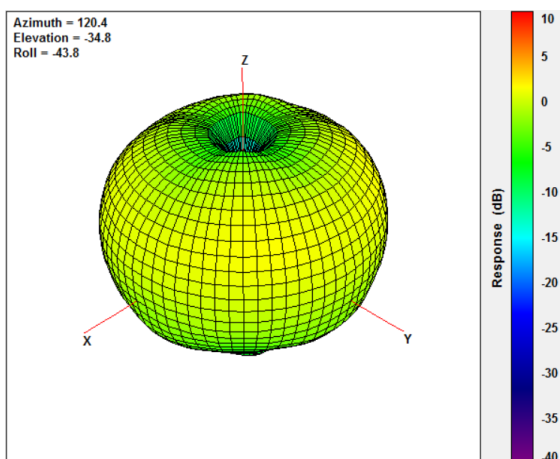

@1710 MHz

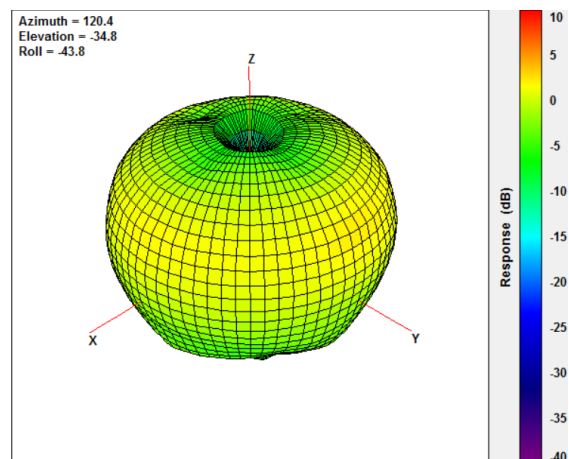

@1880 MHz

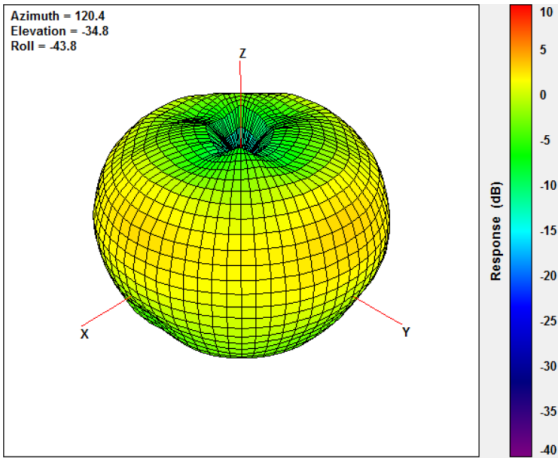

@1990 MHz

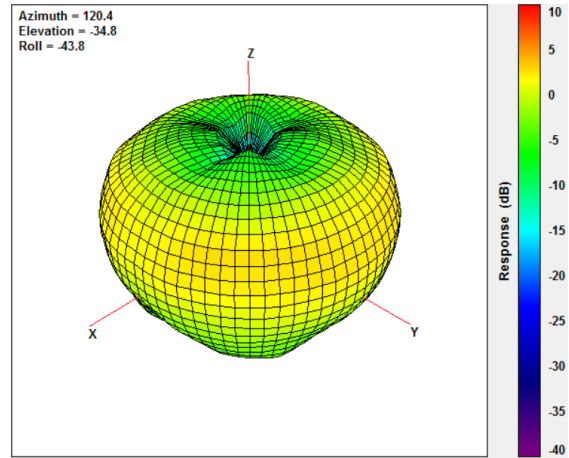

@2170 MHz

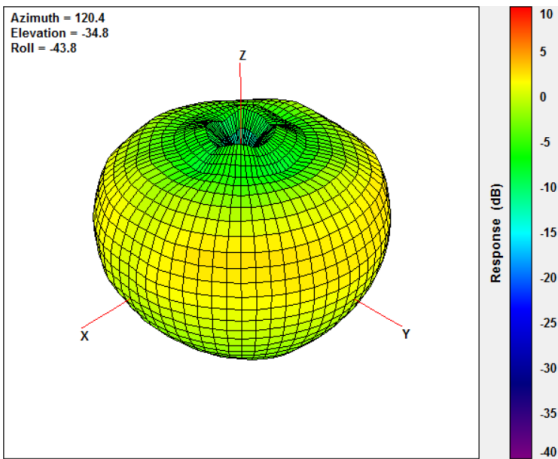

@2300 MHz

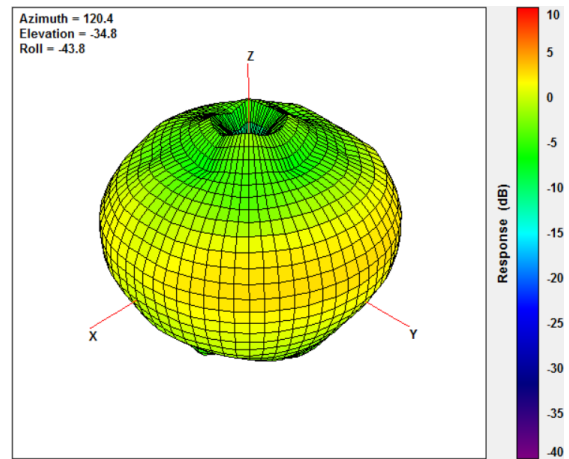

@2690 MHz

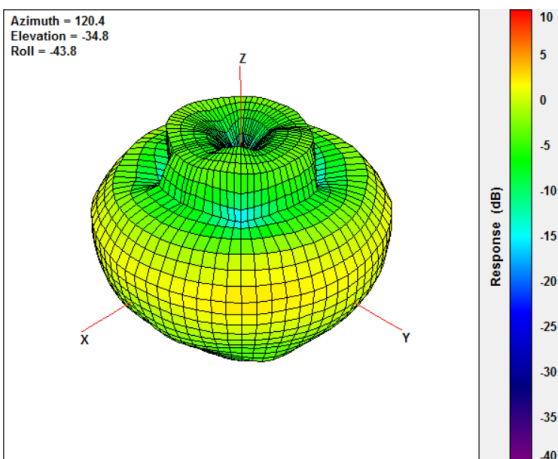

5. Mechanical Drawing (Unit: mm)

Top View

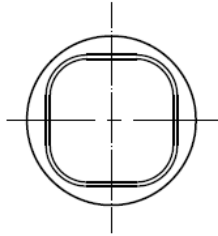

Side View

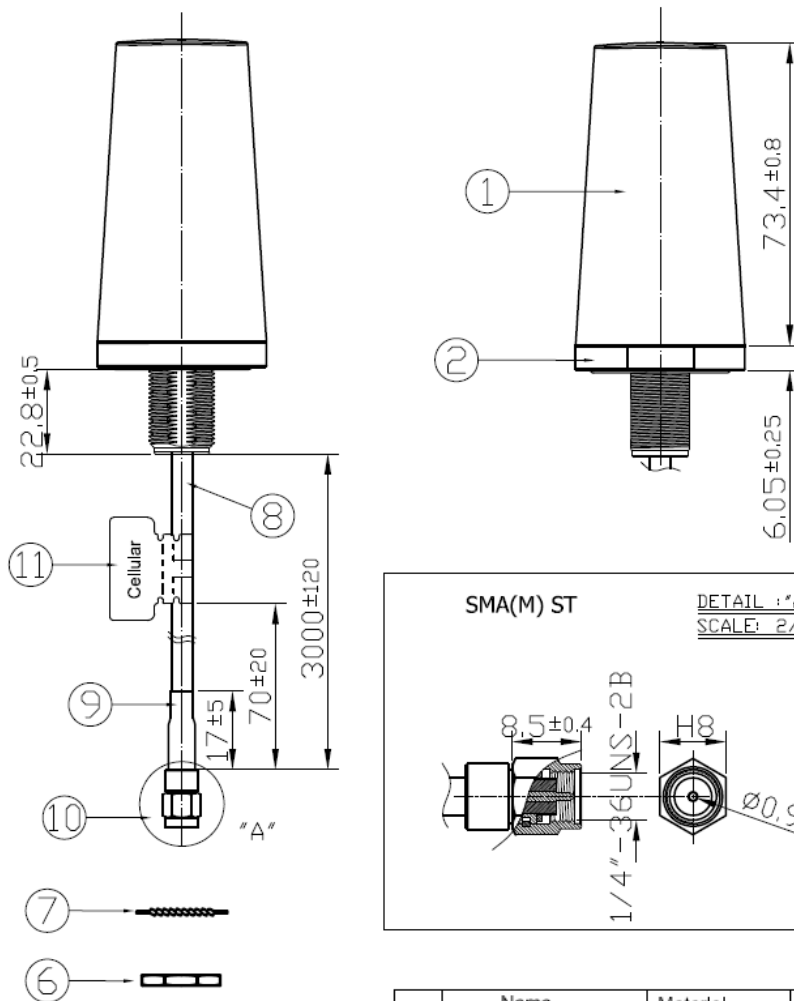

Unit : mm

Bottom View

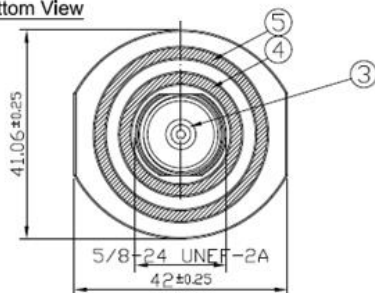

	Name	Material	Finish	QTY
1	Antenna Top	ABS	Black	1
2	Antenna Bottom	Zinc Alloy	Ni Plated	1
3	TLS Thread	Brass	Ni Plated	1
4	O Ring 1	NBR	Black	1
5	O Ring 2	NBR	Black	1
6	Nut	Brass	Ni Plated	1
7	Washer	Brass	Ni Plated	1
8	CFD200 Coaxial Cable	PVC	Black	1
9	Heat Shrink Tube	PE	Black	1
10	SMA(M) ST	Brass	Gold Plated	1
11	Cellular Label	Coated Paper	Blue	1

6. Installation

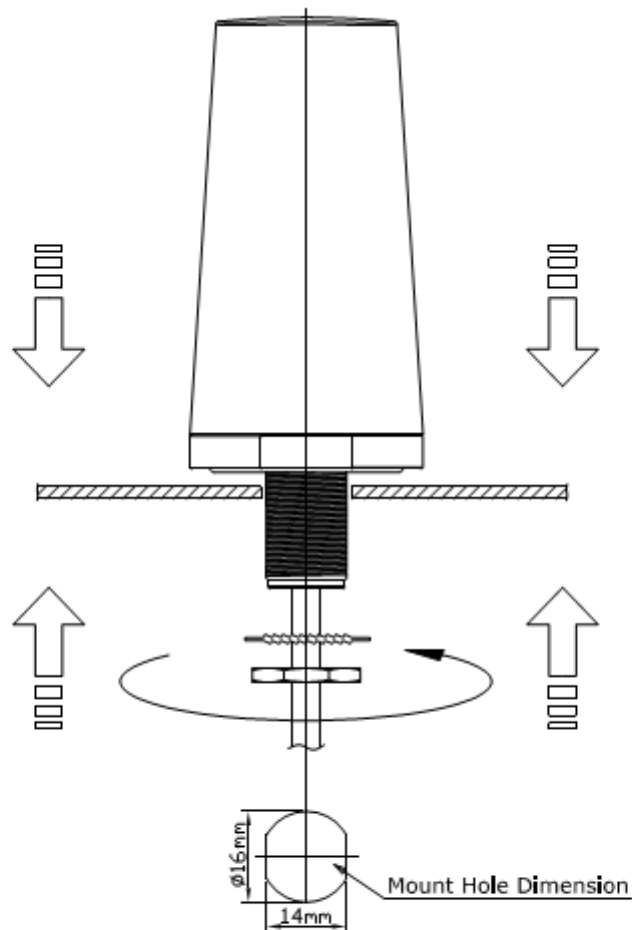

Recommended torque for mounting is 4.018 N.m or 41 kgf.cm

Maximum torque for mounting is 9.8 N.m or 100 kgf.cm

7. Packaging

TLS.01.305111

Packaging Specifications

1 No. TLS.01.305111 per small box
 Box Dimensions - 135 x 135 x 135mm
 Weight - 370g

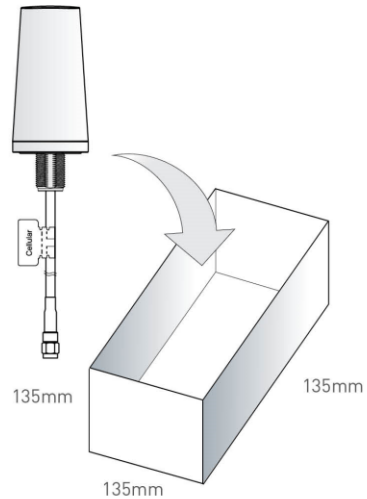

1 Outer Carton
 Carton Dimensions - 430 x 380 x 280mm
 24 pcs TLS.01.305111 per carton
 Weight - 10.2Kg

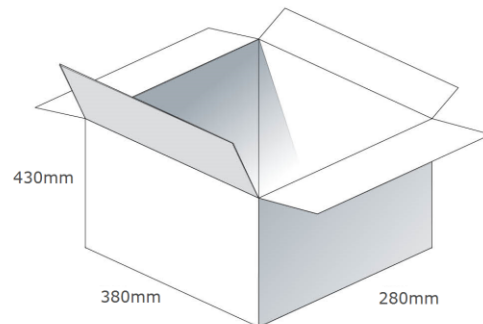

Pallet Dimensions 1100*1100*1510mm
 16 Cartons per Pallet
 4 Cartons per layer
 4 Layers

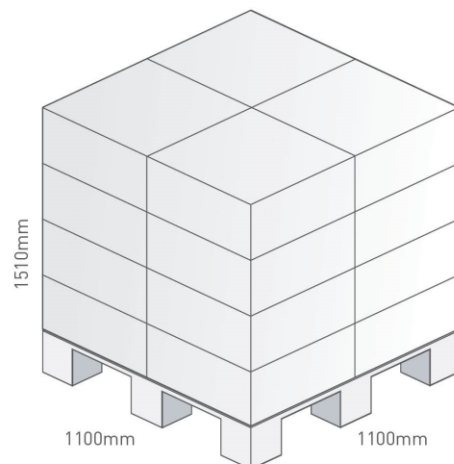

8. Application Note

Antenna performance with different cable lengths is shown below for reference.

- Efficiency

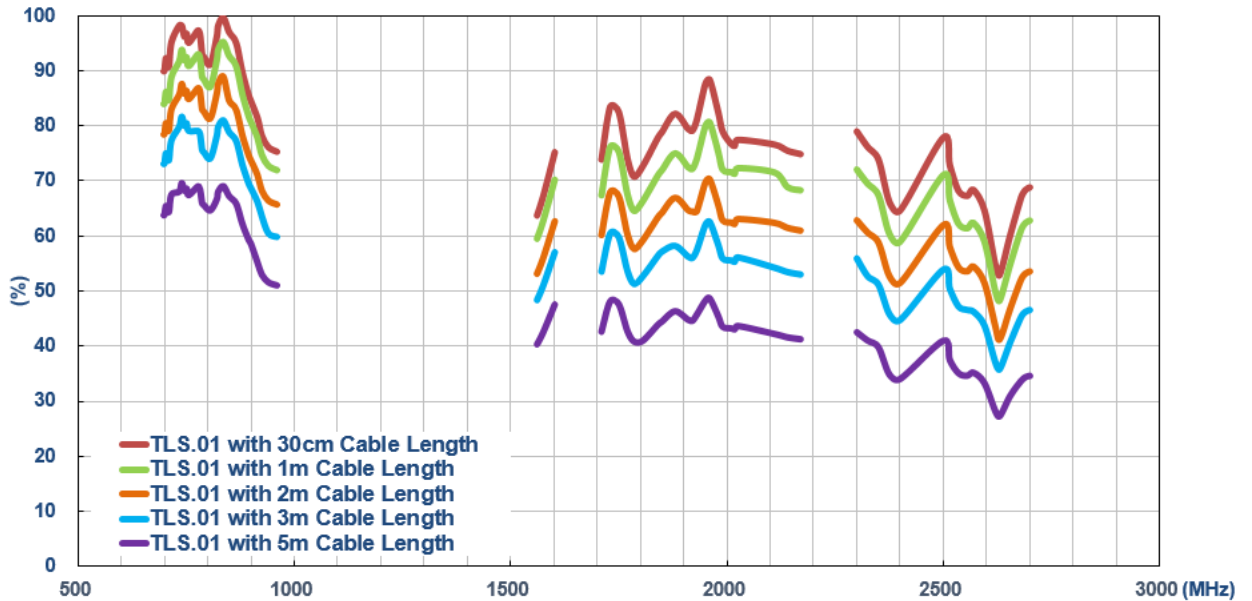

- Peak Gain

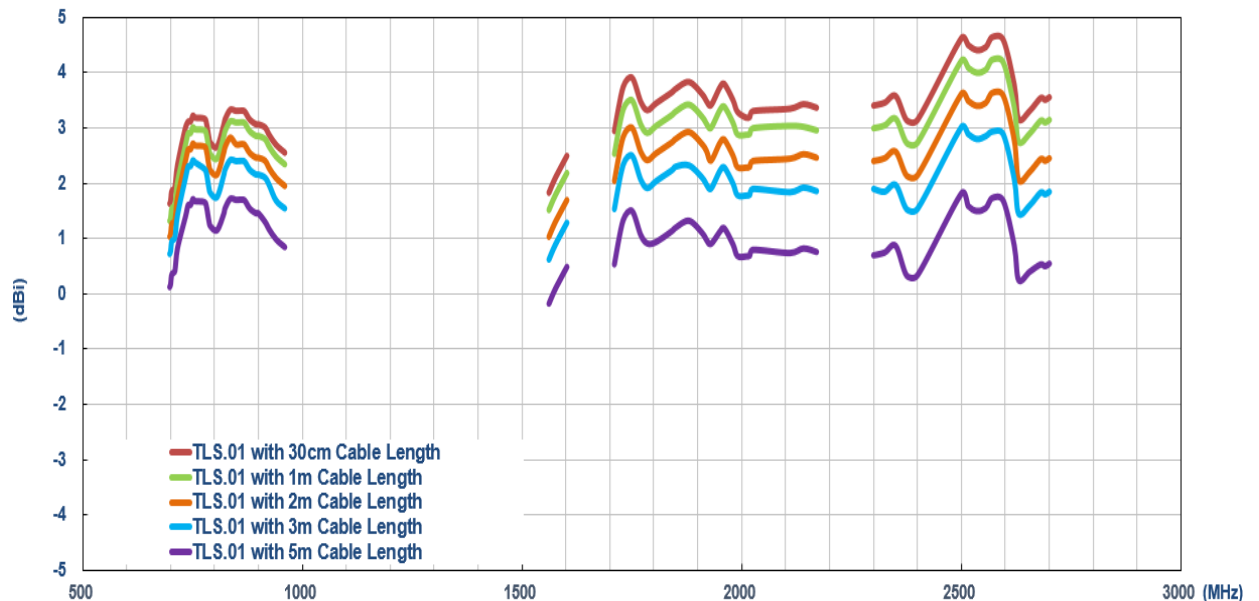

- Average Gain

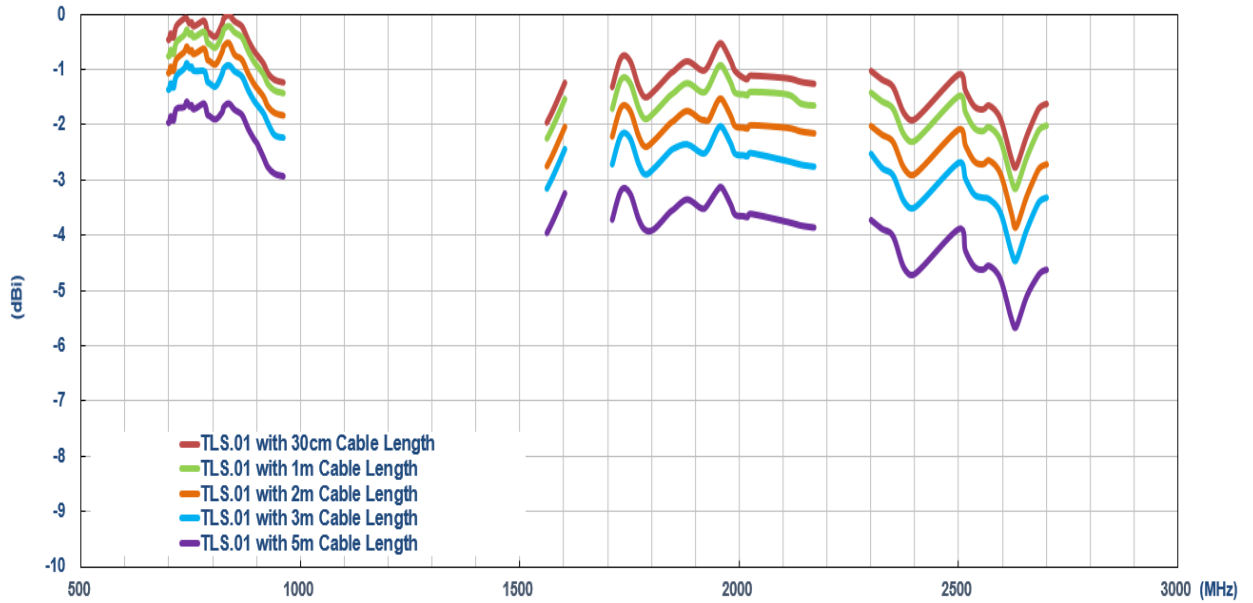

Taoglas makes no warranties based on the accuracy or completeness of the contents of this document and reserves the right to make changes to specifications and product descriptions at any time without notice. Taoglas reserves all rights to this document and the information contained herein.

Reproduction, use or disclosure to third parties without express permission is strictly prohibited.

Copyright © Taoglas Ltd.