

34WAY POLARIZATION OPTION 'A'  
P/N: 34958-0340

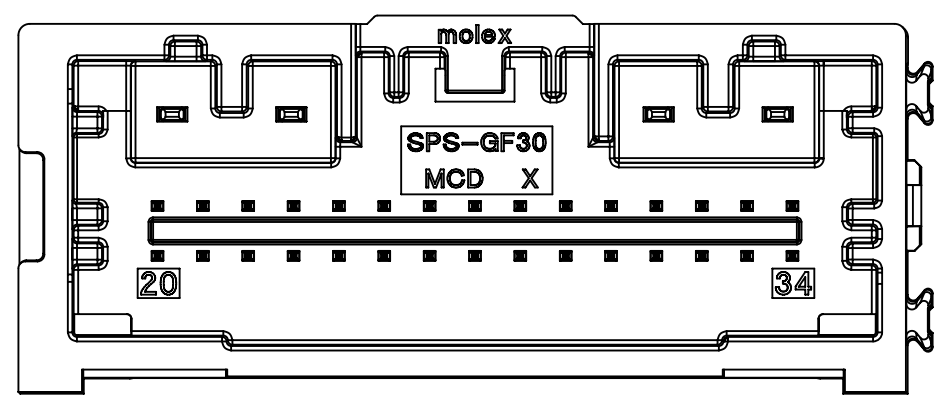

34WAY POLARIZATION OPTION 'B'  
P/N: 34958-0341

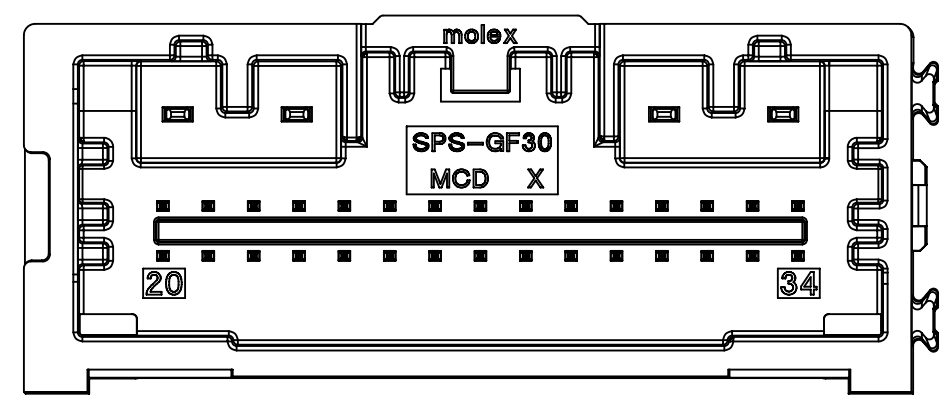

34WAY POLARIZATION OPTION 'C'  
P/N: 34958-0342

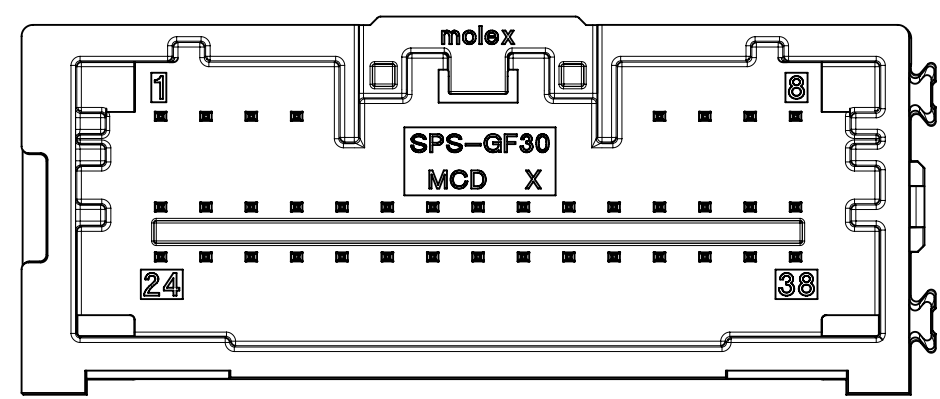

38WAY POLARIZATION UPDATED OPTION 'A'  
P/N: 34958-0383

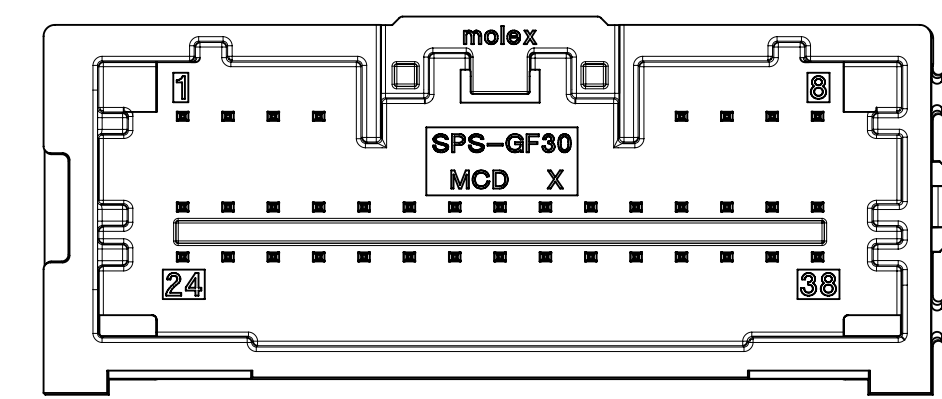

38WAY POLARIZATION UPDATED OPTION 'B'  
P/N: 34958-0384

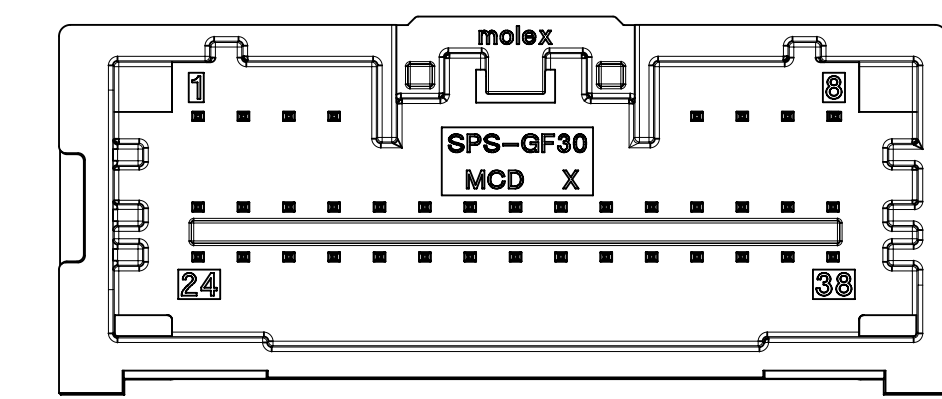

38WAY POLARIZATION UPDATED OPTION 'C'  
P/N: 34958-0385

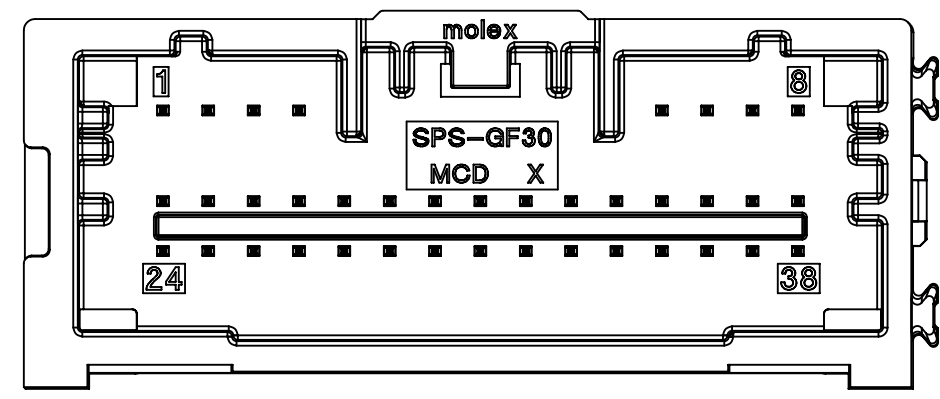

38WAY POLARIZATION OPTION 'A'  
P/N: 34958-0380

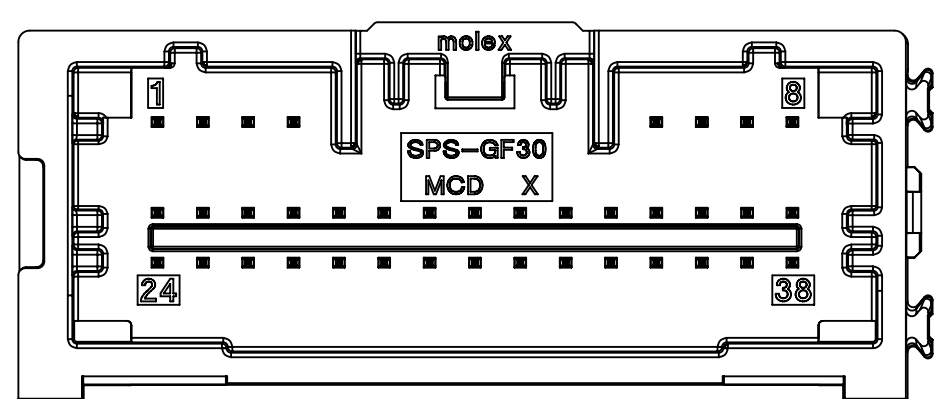

38WAY POLARIZATION OPTION 'B'  
P/N: 34958-0381

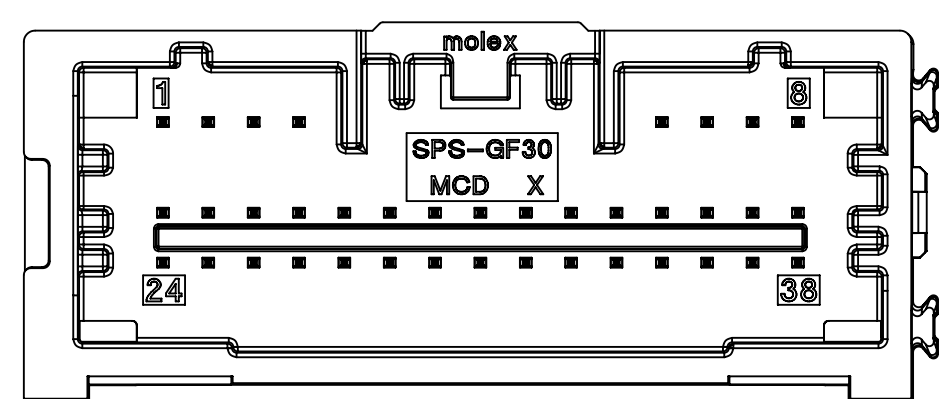

38WAY POLARIZATION OPTION 'C'  
P/N: 34958-0382

NOTES: VALID UNLESS OTHERWISE SPECIFIED

1. GENERAL:

a. CONNECTOR HEADER MUST BE VALIDATED TO THE FOLLOWING FUNCTIONAL REQUIREMENTS:

VALIDATION SPECIFICATION = GMW3191 JUNE 2012

SOLDERABILITY = SMES-152

b. APPLICATION REQUIREMENTS (REFERENCE ONLY) FOR:

SEE APPLICATION SPECIFICATION = AS-34959-001

SEE PRODUCT SPECIFICATION = PS-34959-001

MATES WITH: SD-34959-030

c. PACKAGING SPECIFICATION: SEE TABLE

2. DESIGN: MATERIALS:

a. SHROUD (PLASTIC HOUSING):  
RESIN - SPS 30%GF

b. 0.50mm BLADES:  
BASE MATERIAL: C26800  
PLATING TYPE: AS NOTED

c. 1.2mm BLADES:  
BASE MATERIAL: C26800  
PLATING TYPE: AS NOTED

3. PLATING REQUIREMENTS:

a. UNDERPLATING - OVERALL NICKEL

b. OVERPLATING - OVERALL TIN

MATERIAL NUMBER	CKT SIZE	DESCRIPTION	POL	COLOR	STATUS
34958-0340	34	34WAY MINI50 VERTICAL HEADER ASSEMBLY	A	BLACK	SALEABLE
34958-0341	34	34WAY MINI50 VERTICAL HEADER ASSEMBLY	B	GREY	SALEABLE
34958-0342	34	34WAY MINI50 VERTICAL HEADER ASSEMBLY	C	DK GREY	SALEABLE
34958-0380	38	38WAY MINI50 VERTICAL HEADER ASSEMBLY	A	BLACK	WILL BE OBSOLETE IN 2019
34958-0381	38	38WAY MINI50 VERTICAL HEADER ASSEMBLY	B	GREY	WILL BE OBSOLETE IN 2019
34958-0382	38	38WAY MINI50 VERTICAL HEADER ASSEMBLY	C	DK GREY	WILL BE OBSOLETE IN 2019
34958-0383	38	38WAY MINI50 VERTICAL HEADER ASSEMBLY	UPDATED A	BLACK	SALEABLE
34958-0384	38	38WAY MINI50 VERTICAL HEADER ASSEMBLY	UPDATED B	GREY	SALEABLE
34958-0385	38	38WAY MINI50 VERTICAL HEADER ASSEMBLY	UPDATED C	DK GREY	SALEABLE

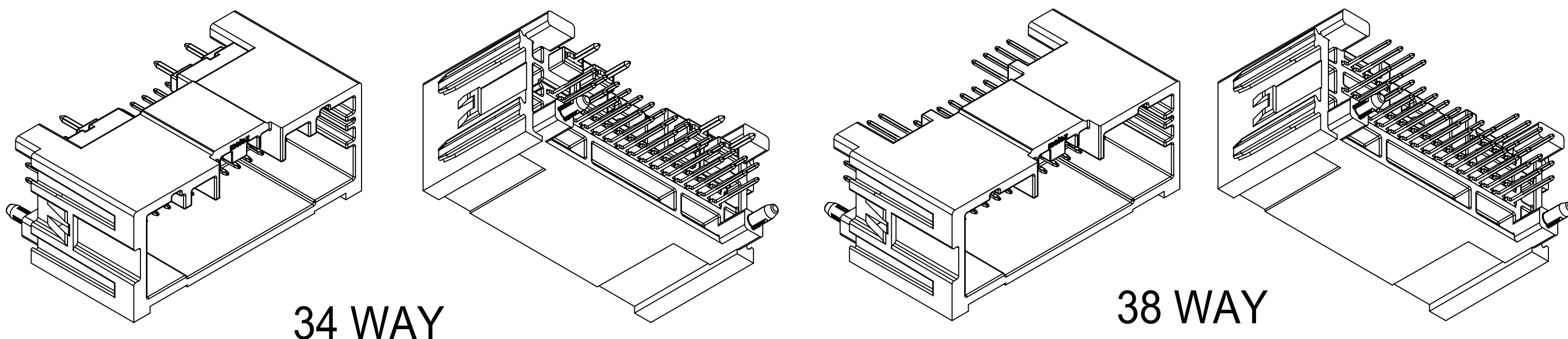

34 WAY

38 WAY

ISOMETRIC VIEWS  
SCALE 2:1

C	ADDED NEW VIEW OF UPDATED POL A & B C, SEE SHEET 1. ADDED NEW P/N IN THE BOM ON SHEET 1: 34958-0383 \ 34958-0384 \ 34958-0385 \ 34958-7383 \ 34958-7384 \ 34958-7385 \ 34958-8383 \ 34958-8384 \ 34958-8385. ADDED PRODUCT STATUS IN THE BOM.	10886111
C	REV	ECN SAP NO.

SYMBOLS	THIS DRAWING CONTAINS INFORMATION THAT IS PROPRIETARY TO MOLEX ELECTRONIC TECHNOLOGIES, LLC AND SHOULD NOT BE USED WITHOUT WRITTEN PERMISSION		
	DIMENSION UNITS	SCALE	CURRENT REV DESC:
▽ = 0	mm	3:1	EC NO: 172887 DRWN: SWU31 2018/02/28 CHK'D: CDZHANG 2018/03/12 APPR: JDENG02 2018/03/15
▽ = 0	GENERAL TOLERANCES (UNLESS SPECIFIED)		
▽ = 0	ANGULAR TOL ± 1.0°		INITIAL REVISION: DRWN: JFISCHER01 2013/12/05 APPR: RBAUMAN 2014/02/19
▽ = 0	4 PLACES ±		
▽ = 0	3 PLACES ±		DOCUMENT NUMBER: SD-34958-300 DOC TYPE: PSD DOC PART: 001 REVISION: C
▽ = 0	2 PLACES ±		
▽ = 0	1 PLACE ±		MATERIAL NUMBER: 34958 CUSTOMER: GENERAL MARKET SHEET NUMBER: 1 OF 2
▽ = 0	0 PLACES ±		
■ = 0	DRAFT WHERE APPLICABLE MUST REMAIN WITHIN DIMENSIONS		
▽ = 0	THIRD ANGLE PROJECTION	DRAWING	SERIES
		D-SIZE	34958

