

REV.	DESCRIPTION	DATE
A	NEW DRAWING	3/29/2007

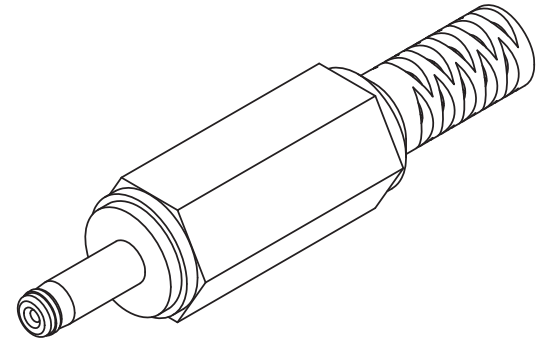

TOLERANCE:
 X.X ± 0.2 mm
 X.XX ± 0.1 mm
 X.XXX ± 0.05 mm

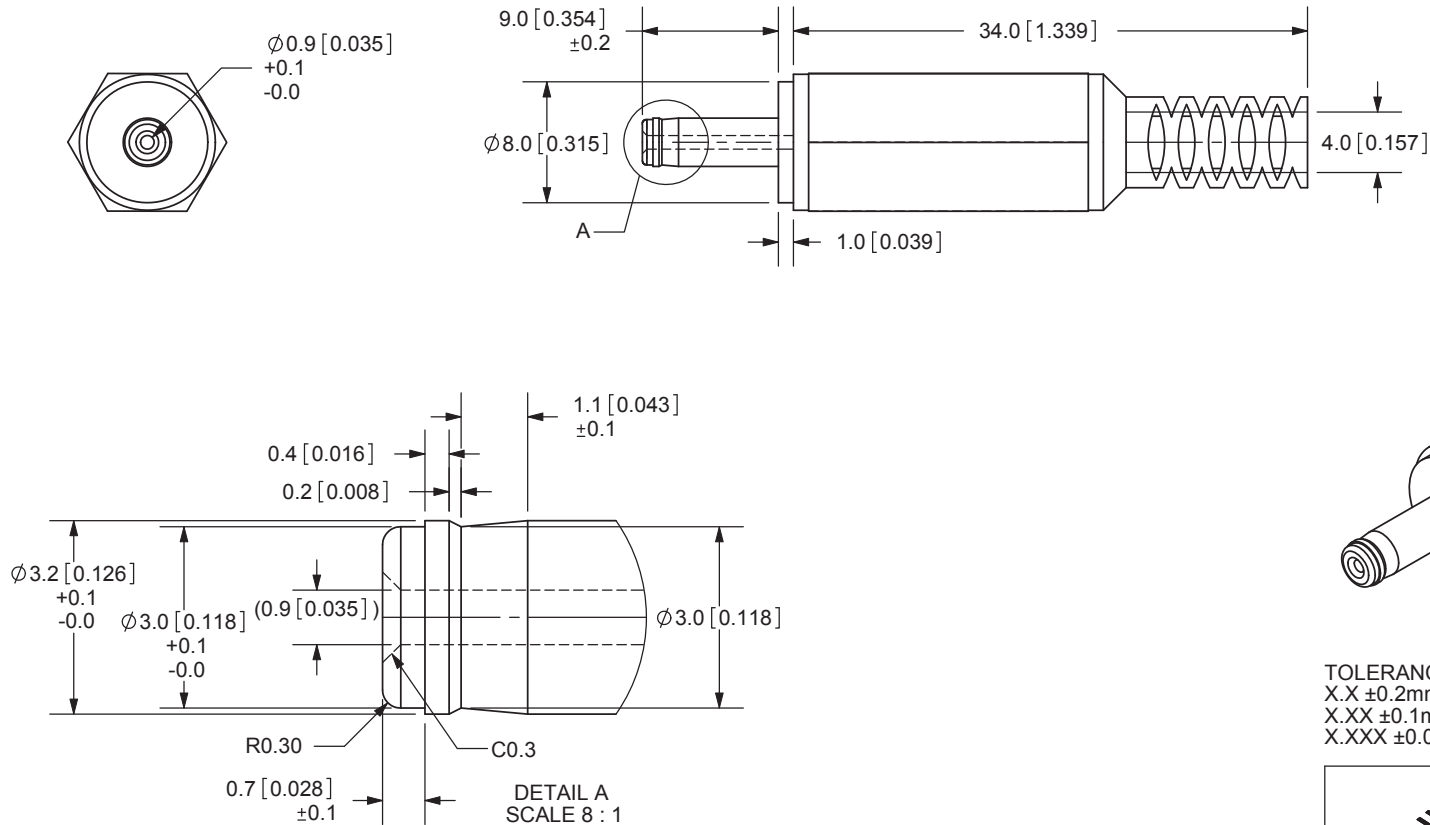

SPECIFICATIONS:
 RATING: 16V DC @ 4A
 INSULATION RESISTANCE: 100M OHMS MIN: 500V DC
 VOLTAGE WITHSTAND: 500V AC R.M.S. FOR 1 MINUTE
 LIFE: 5,000 CYCLES
 OPERATING TEMP: 0° ~ +40°C



20050 SW 112th Ave.
 Tualatin, OR 97062
 Phone: 503-612-2300
 800-275-4899
 Fax: 503-612-2383
 Website: www.cui.com

	MATERIAL	PLATING
COVER	PVC	Black Color
PIN	Brass	Nickel
BARREL	Brass	Nickel
TERMINALS	Brass	Nickel
TIP INSULATOR	POM	Black Color

TITLE: DC POWER PLUG	REV: A
PART NO. PP-017	UNITS: MM [INCHES]
DRAWN BY: ZRJ	APPROVED BY:
	SCALE: 2:1

PC FILE NAME:
 PP-017

COPYRIGHT 2009 BY CUI INC.