

SNA-01-223

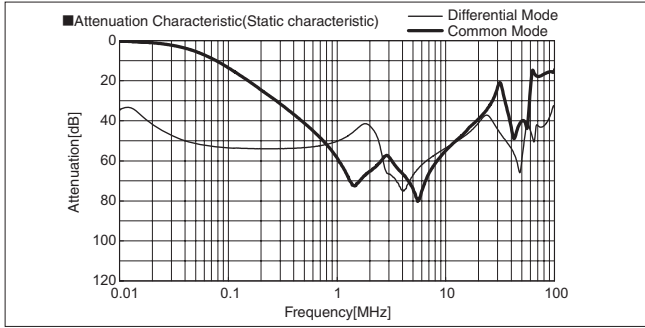

SNA-03-223

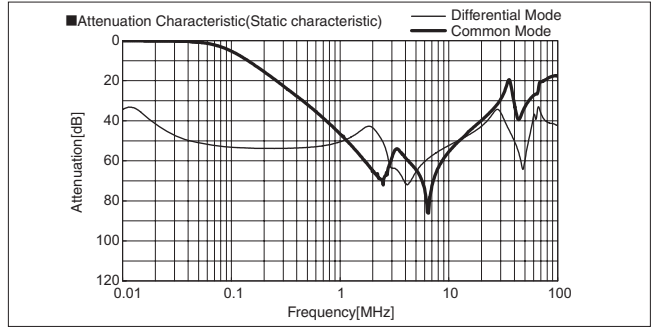

SNA-06-223

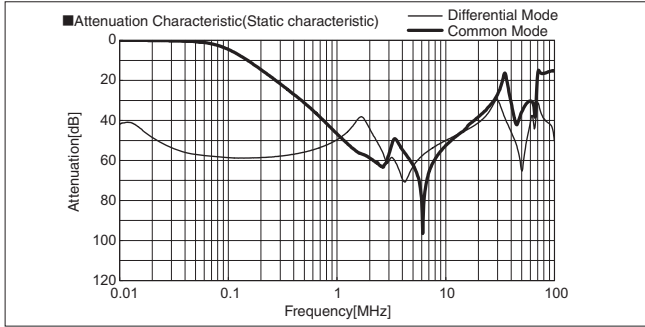

SNR-10-223

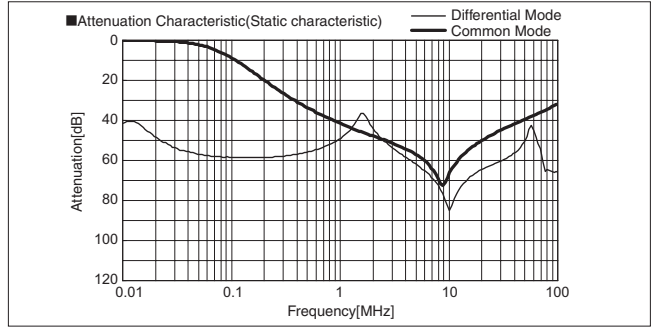

Example of attenuation output noise.

※ This product only reduces ripple noise of the switch mode power supply. It cannot be used effectively to reduce ripple noise at line frequency.

LCA10S-12

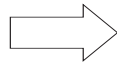
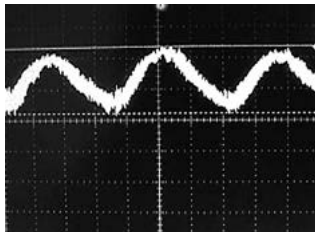

LCA10S-12+SNA-01-223

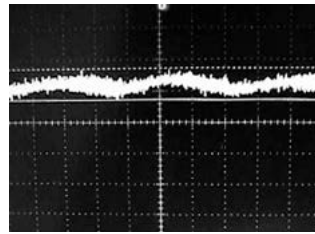

(Room temp, Room Humi)  
BW:500MHz  
LCA10S-12  
12V 0.9A

LCA30S-12

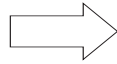
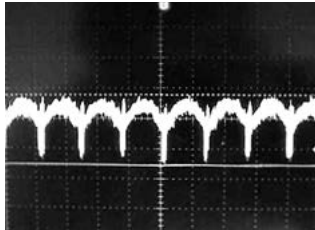

LCA30S-12+SNA-03-223

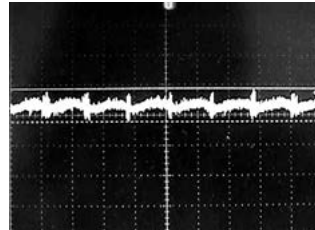

(Room temp, Room Humi)  
BW:500MHz  
LCA30S-12  
12V 2.5A

LCA50S-12

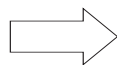
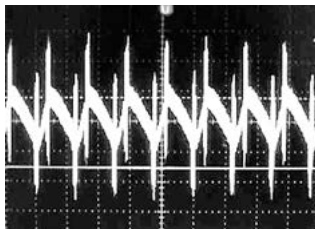

LCA50S-12+SNA-06-223

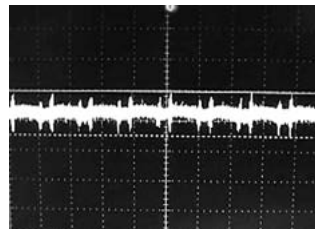

(Room temp, Room Humi)  
BW:500MHz  
LCA50S-12  
12V 4.3A

LEP240F-24

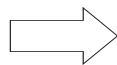
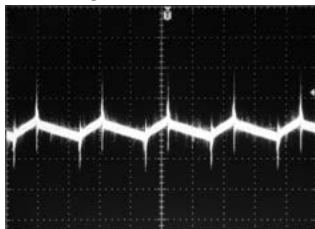

LEP240F-24+SNR-10-223

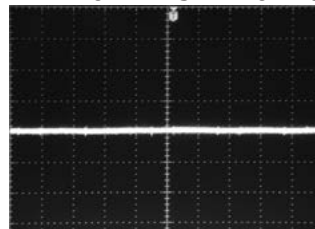

(Room temp, Room Humi)  
BW:500MHz  
LEP240F-24  
24V 10A

※ Measured by differential probe (KEISOKU-GIKEN:DP-100).

# 1 Wiring to Input/Output terminals

■ This filter uses polarized components (electrolytic capacitor), The filter will break if reverse voltage is applied to the input/output terminals. Please exercise caution when wiring.

# 2 Application examples

■ Power supply for an operational amplifier.

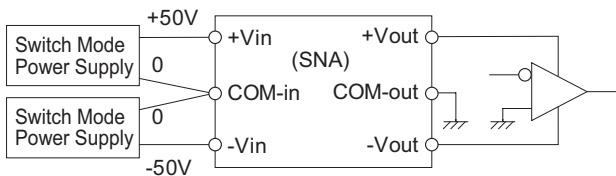

■ Single output power supply.

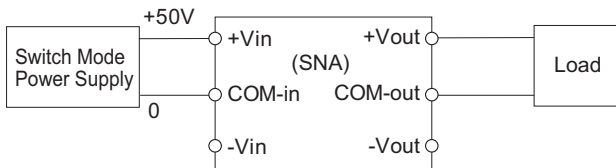

# 3 Safety Considerations

■ To apply for safety standard approval using this EMI/EMC Filter, the following conditions must be met.

- The unit must be used as a component of an end-use equipment.
- The unit must be used in the secondary circuit that is insulated from the primary circuit through double or reinforced insulation.
- The mounting plate (FG) must be connected to safety ground of end-use equipment.

# 4 Optional Parts

■ The harness for Input/Output of EMI/EMC Filter is available.

Model	Harness model
SNA-01	H-OU-8
SNA-03	H-OU-8
SNA-06	H-OU-9
SNR-10	H-OU-18

※ The same harness model applies to both input and output.

※ Sold in units of 1 piece.

# 5 Peak current (SNR)

■ Peak current is possible to draw as below.

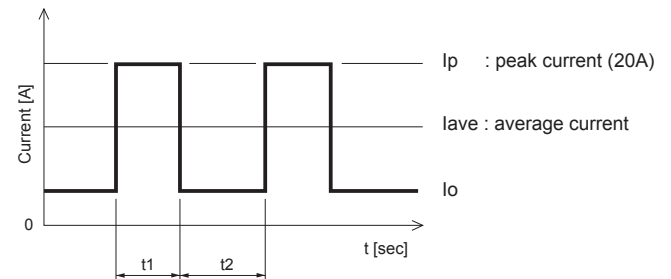

$$t1 \leq 10 \text{ [sec]}, I_{ave} = \frac{I_p \cdot t1 + I_o \cdot t2}{t1 + t2} \leq \text{rated current}$$

$$\frac{t1}{t1 + t2} \leq \text{Duty}$$

Duty is depended on peak current, refer to below chart.

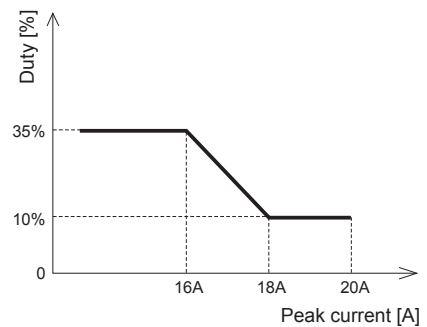

# 1 Noise Transmission

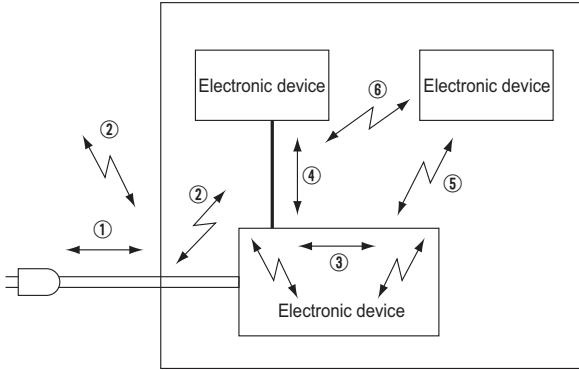

Noise transmission between electric power and electronic device

- ① Conducted noise from electric power lines.
- ② Radiated noise which is picked up and generated by the power line as antenna.
- ③ Conducted and radiated noise which is generated in the electronic device.
- ④ Conducted noise which is generated by the signal lines between electronic devices.
- ⑤ Radiated noise emitted an electronic device that interferes with other device.
- ⑥ Radiated noise which is picked up and generated by the signal line as antenna.

# 2 Application Precautions

The following points should be kept in mind to use the EMI/EMC Filter more effectively.

■ Input wire and output wire of the EMI/EMC Filter should be separated.

When the input/output wire are bundled together or wired parallel with each other, high frequency noise is induced so, and the expected effect of noise attenuation cannot be achieved.

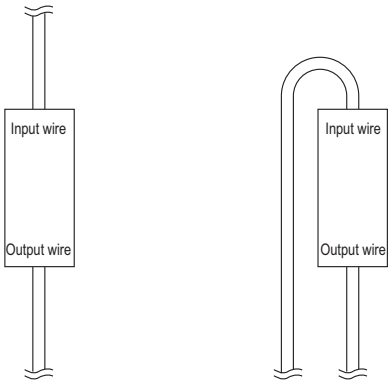

Good wiring example

Bad wiring example

■ Ground lines should be as short as possible. If it is not, an equivalent inductance appears, and the high frequency attenuation characteristics degrade. When grounding the mounting plate of the EMI/EMC Filter, you should remove the paint to reduce the contact resistance from the equipment case, and then install the EMI/EMC Filter.

### 3 Method of measuring characteristic data

※ Attenuation =  $20\log(U_{01}/U_{02})$  [dB]  
 $U_{01}$  : Voltage in state without filters  
 $U_{02}$  : Voltage in state which added filters  
 ※ N.A. : Network analyzer

#### (1) Attenuation Characteristic(Static characteristic)

Object product: Single phase input type

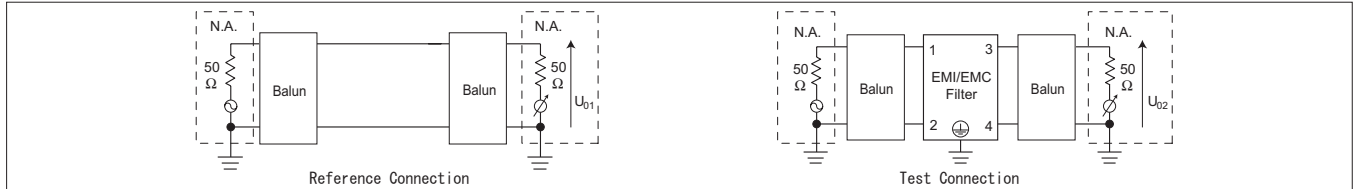

Fig.3.1 Differential mode attenuation measurement diagram

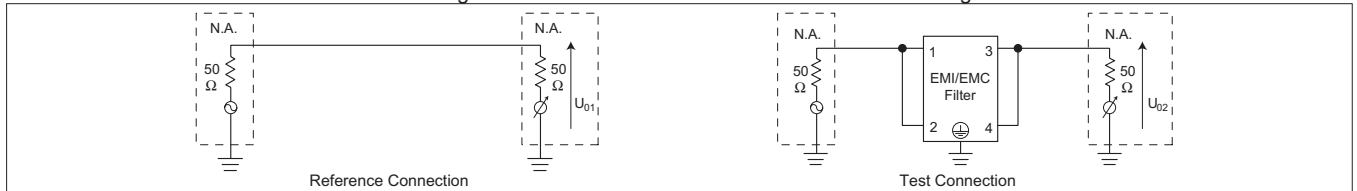

Fig.3.2 Common mode attenuation measurement diagram

Object product: Three phase input type

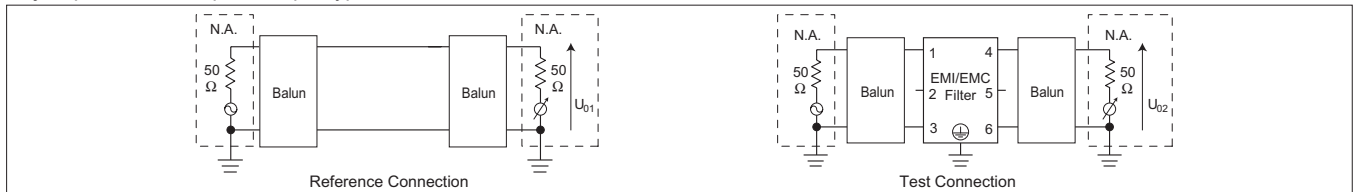

Fig.3.3 Differential mode attenuation measurement diagram

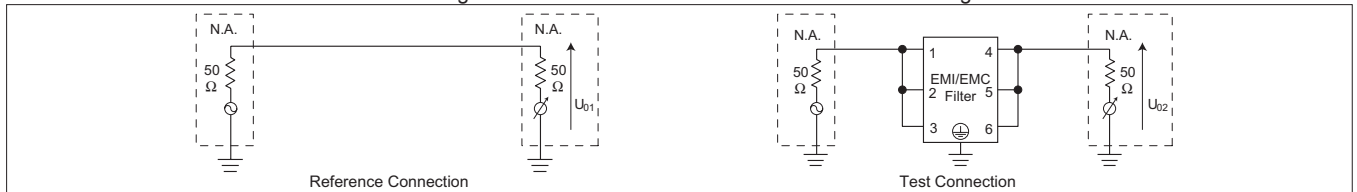

Fig.3.4 Common mode attenuation measurement diagram

Object product: DC input type

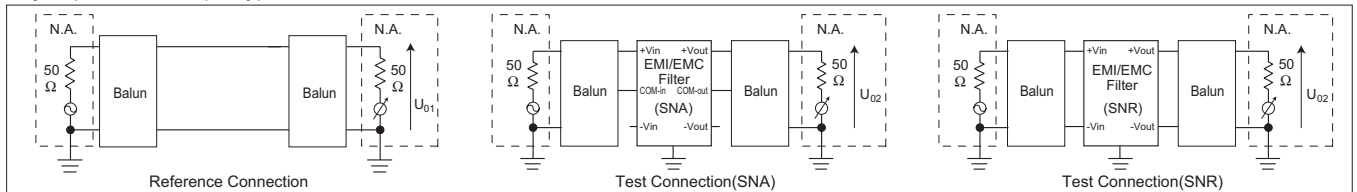

Fig.3.5 Differential mode attenuation measurement diagram

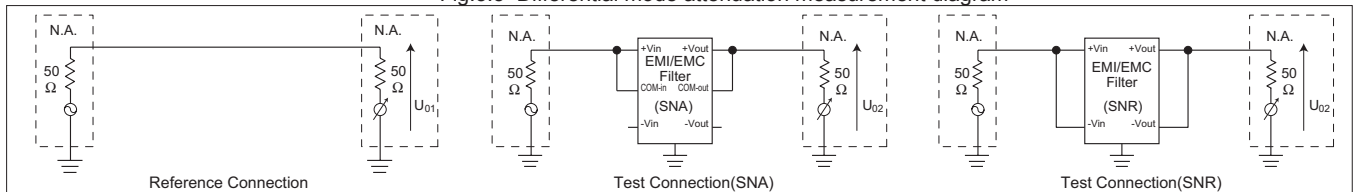

Fig.3.6 Common mode attenuation measurement diagram

#### (2) Pulse Attenuation Characteristic

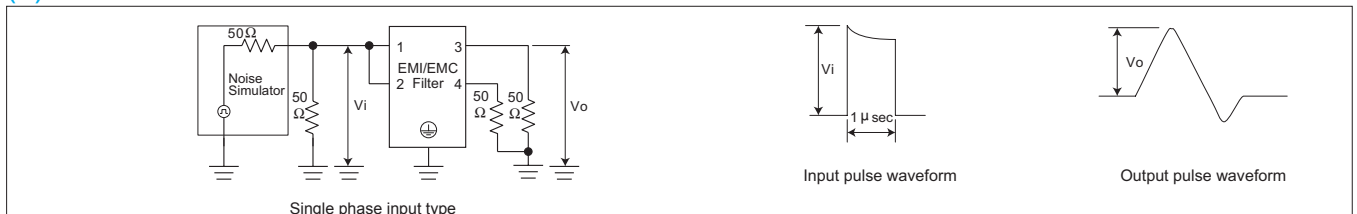

Fig.3.7 Pulse attenuation measurement diagram