

To \_\_\_\_\_

No. A226-040403B-01

Date 3rd Apr. '04

Type No.  
**GRAB4**

Data Sheet

<b>GPS Rx SAW Filter</b>	
Application	: Rx Filter for GPS
Center Frequency	: 1575.42MHz
Size	: 2.0x1.4mm, 5pin-layout
Impedance	: 50-100ohms unbalance-balance
Part No.	: EFCH1575TCA1

Issued *Y. Watanabe*

Check *K. Nishimura*

CIRCUIT COMPONENTS BUSINESS UNIT

**MATSUSHITA ELECTRONIC COMPONENTS CO.,LTD**

KADOMA, OSAKA, JAPAN

**GPS RF SAW Filter, 1575.42MHz**  
**Design NO. dubw027**  
**== Preliminary Specification ==**

Parameter		Frequency (MHz)	Your requirements			Our puropusal			Unit
			Min.	Typ.	Max.	Min.	Typ.	Max.	
Center Frequency (fo)				1575			1575.4		
Insertion Loss		1575.42 MHz			1.8		1.1	1.5	dB
Pass band ripple		1574.42 to 1576.42MHz			0.7		0.1	0.3	dBpp
Attenuation	Att1	<1475MHz	30			35	42		dB
	Att2	1475 to 1525MHz	10			20	25		
	Att3	1625 to 1675MHz	10			20	27		
	Att4	1675 to 3155MHz	30			30	35		
	Att5	>3155MHz	20			30	43		
Mean Square Phase Error		1574.42 to 1576.42MHz			1		0.4	0.8	°rms
Phase Imbalance					+/-20	-20	5	20	Degree
Amplitude Imbalance					+/-2	-2	0.8	2	dB
In/Out VSWR		1574.42-1576.42		1.1	1.5		1.1	1.5	
Terminate impedance(in)		Single-ended	50			50			ohm
(out)		Differential	100			100			ohm
Operating Temperature			-30	25	85	-30	25	85	°C

a value which pulled JIG Loss:0. 2dB.

# GPS Rx SAW Filter

Design No dubw027

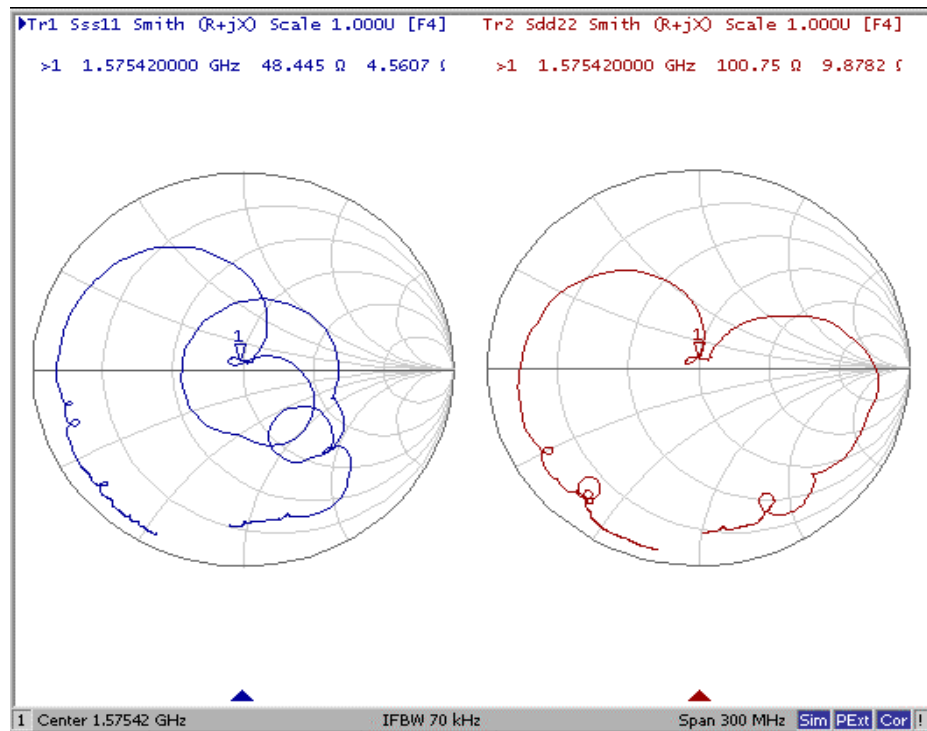
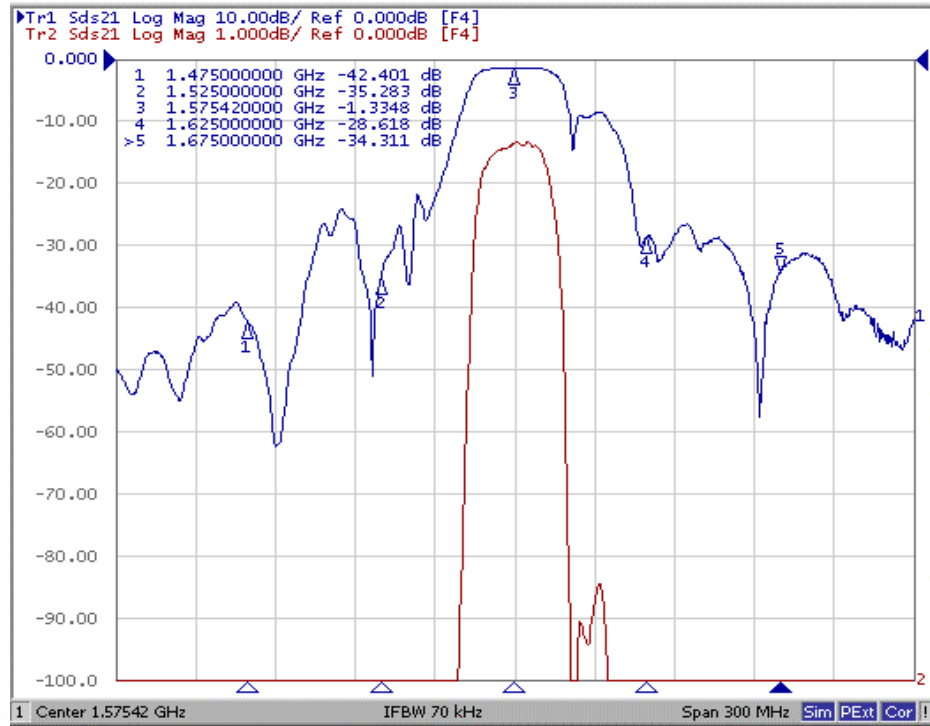

# GPS Rx SAW Filter

Design No dubw027

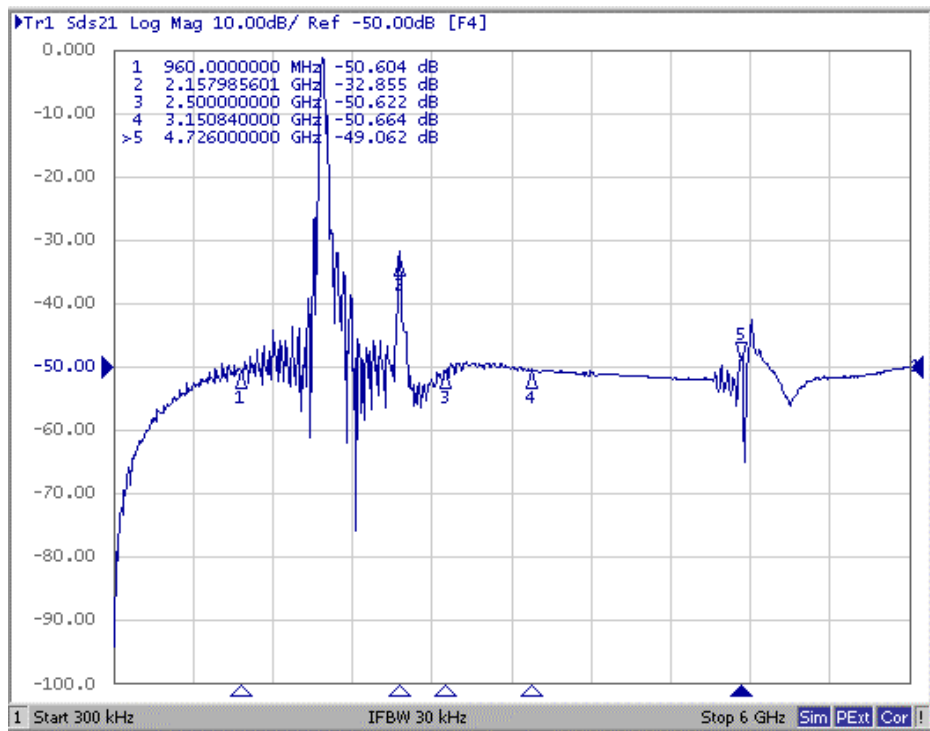

# GPS Rx SAW Filter

Design No dubw027

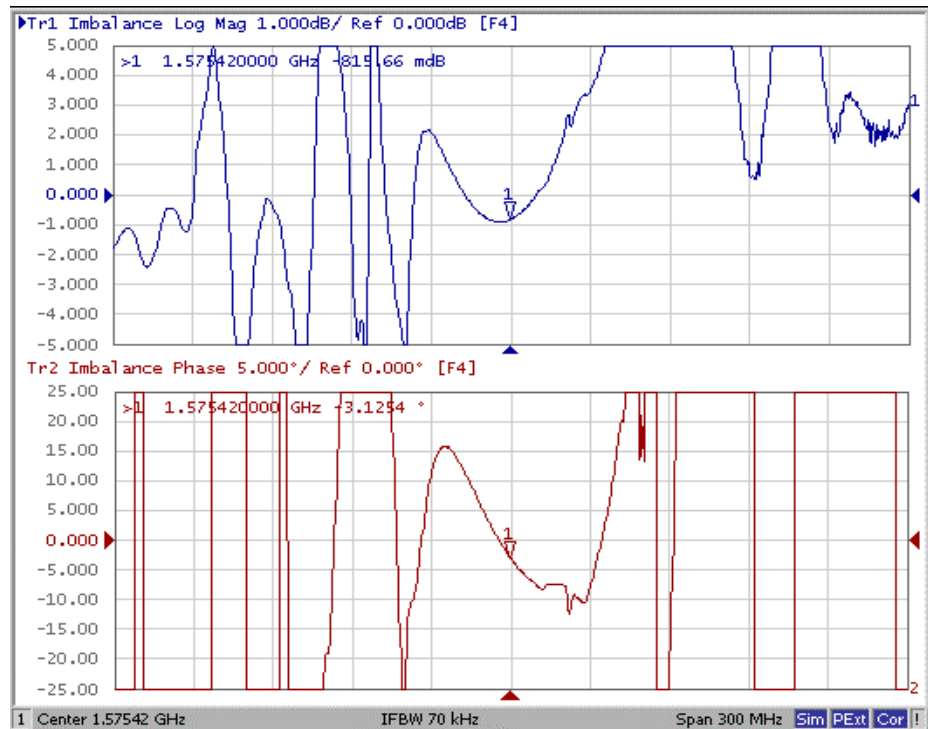
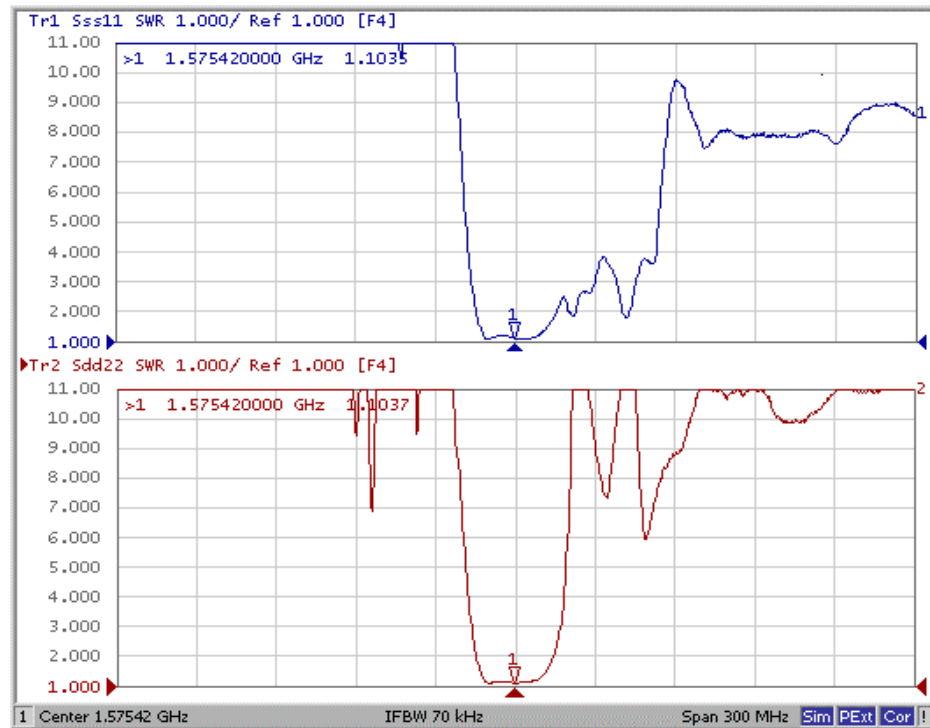

THIRD ANGLE PROJECTION

Tolerance : +/-0.05

*Under Development*

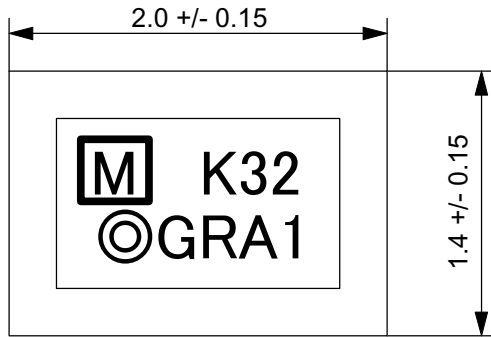

Marking

$\frac{K\ 3\ 2}{\textcircled{3}\ \textcircled{2}}$   
 $\frac{GRA1}{\textcircled{1}}$

- ①: Type Symbol
- ②: Date Code  
3\_YEAR  
2\_MONTH
- ③: Factory Copde  
(Show the production place as below)  
K:MACO

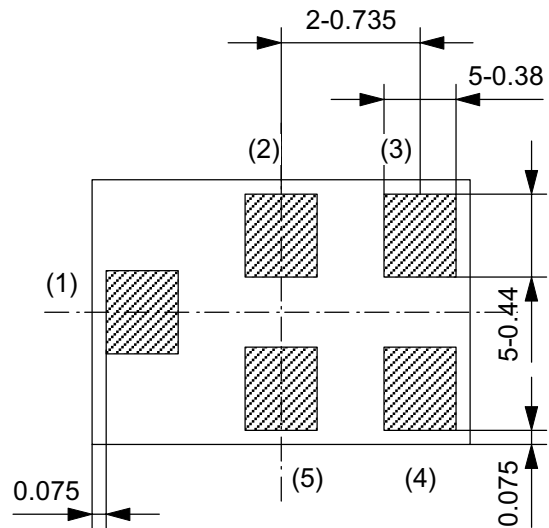
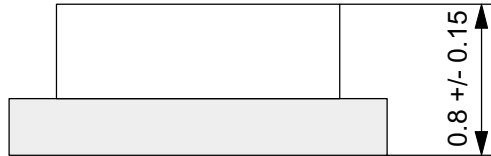

- (1) Input
- (2) GND
- (3) Output
- (4) Output
- (5) GND

**Note :**  
The design manufacturing process,  
and Specification of this device  
are subject to change without  
notice.

UNLESS OTHERWISE SPECIFIED		
BASIC DIMENSIONS		TOLERANCE
UP TO	INCL	
TO	INCL	
TO	INCL	
TO	INCL	
ABOVE		

--	--	--

ISSUE	REVISIONS	DATE
MATERIAL	FINISH	SCALE
DESIGN		
DRAW		
CHECK		
APPROVAL		
DRAWING NO.		

NAME	TYPE NO.
SAW Filter	

**CERAMIC BUSINESS UNIT, LCR DEVICE COMPANY  
MATSUSHITA ELECTRONIC COMPONENTS CO.,LTD.  
KADOMA, OSAKA, JAPAN**

DO NOT SCALE DRAWING

REVISIONS INDICATED BY Æ

ALL DIMENSIONS ARE IN MILLIMETERS

THIRD ANGLE PROJECTION

# Mesurement Circuit

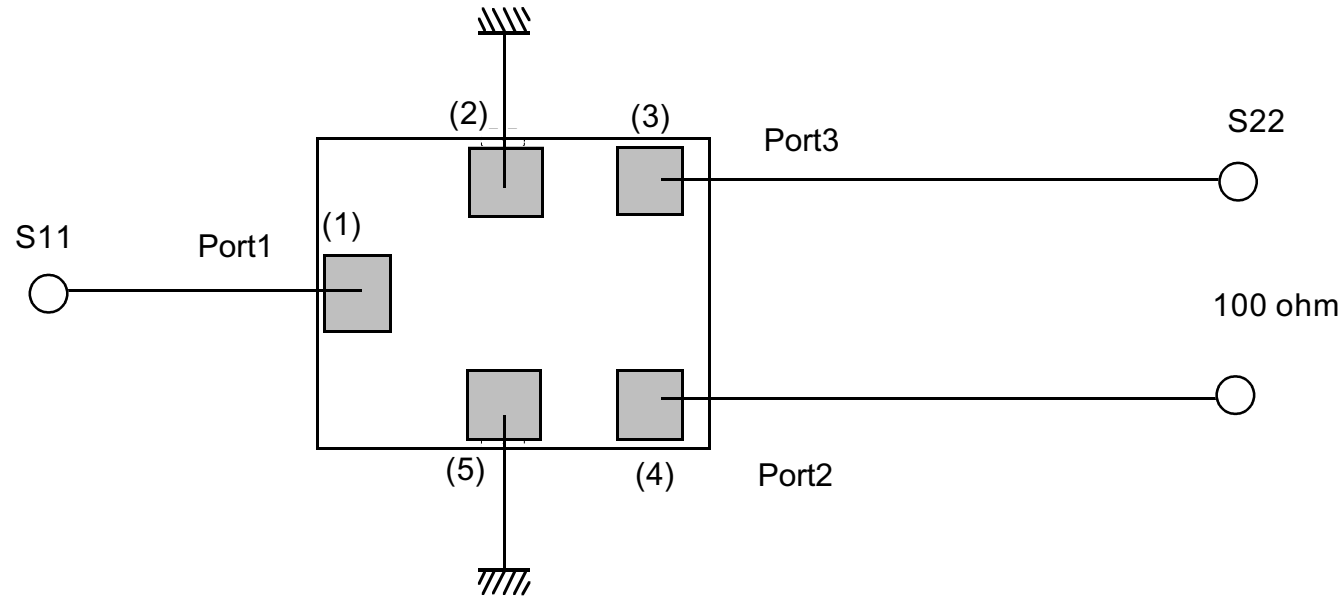

Input impedance: 50 Ohm (Single ended)  
 Output impedance: 100 Ohm (Differential)

UNLESS OTHERWISE SPECIFIED

BASIC DIMENSIONS		TOLERANCE
UP TO	INCL	
TO	INCL	
TO	INCL	
TO	INCL	
ABOVE		

--	--	--

ISSUE	REVISIONS		DATE
	MATERIAL	FINISH	SCALE
DESIGN			
DRAW			
CHECK			
APPROVAL			
DRAWING NO.			

NAME NO.	<b>SAW filter</b>	TYPE
CERAMIC BUSINESS UNIT , LCR DEVICE COMPANY MATSUSHITA ELECTRONIC COMPONENTS CO.,LTD. KADOMA, OSAKA, JAPAN		

THIRD ANGLE PROJECTION

Recommended land pattern

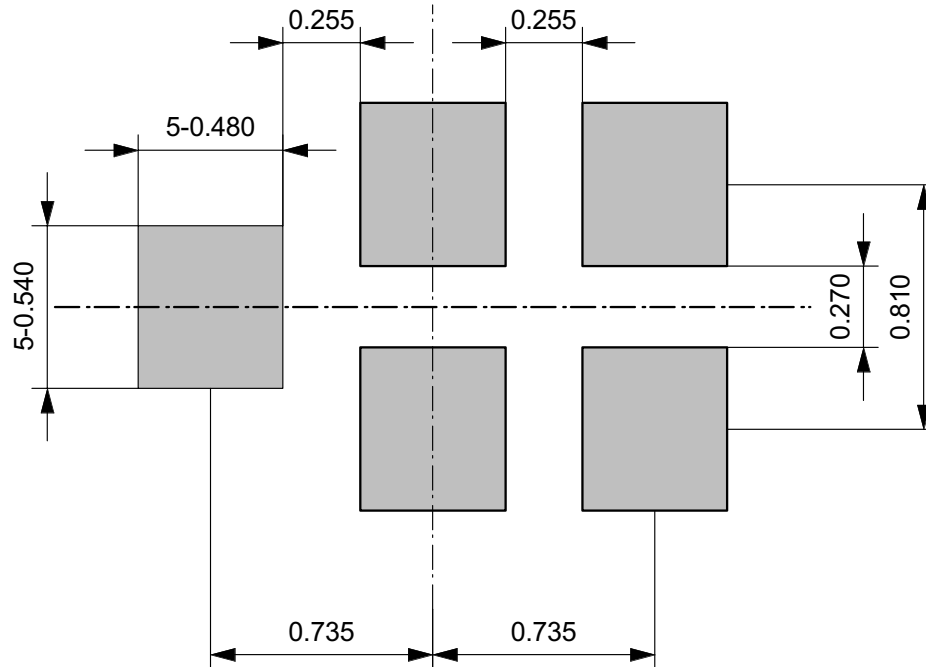

**Note :**  
 The design manufacturing process, and Specification of this device are subject to change without notice.

UNLESS OTHERWISE SPECIFIED

BASIC DIMENSIONS		TOLERANCE
UP TO	INCL	
TO	INCL	
TO	INCL	
TO	INCL	
ABOVE		

--	--	--

ISSUE	REVISIONS		DATE
MATERIAL	FINISH	SCALE	
DESIGN			
DRAW			
CHECK			
APPROVAL			
DRAWING NO.			
NAME		TYPE NO.	

SAW Filter

CERAMIC BUSINESS UNIT, LCR DEVICE COMPANY  
 MATSUSHITA ELECTRONIC COMPONENTS CO.,LTD.  
 KADOMA, OSAKA, JAPAN

DO NOT SCALE DRAWING

REVISIONS INDICATED BY Δ

ALL DIMENSIONS ARE IN MILLIMETERS