

3P Series Miniature Pushwheel Switches

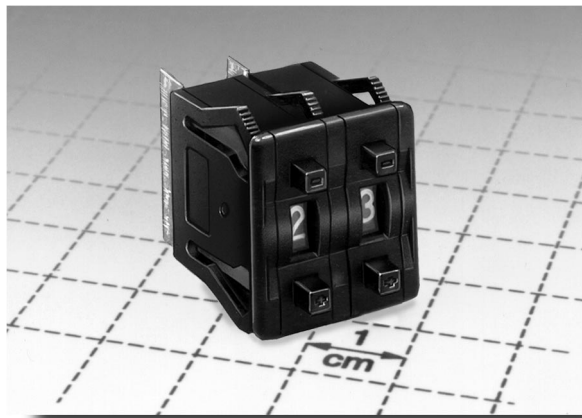

Features/Benefits

- Snap-in front mount design for easy assembly
- 10 position models available
- Illuminated backlighting available

Typical Applications

- Test & measurement equipment
- Industrial machinery
- Computer peripherals

Build-A-Switch

Our easy Build-A-Switch concept allows you to mix and match options to create the switch you need. Below is a complete listing of options shown in catalog. To order, simply select desired option from each category and place in the appropriate box. Available options are shown and described on pages J-19 thru J-21. For additional options not shown in catalog, consult Customer Service Center.



Thumbwheel & Pushwheel

Typical Example: **3 P** — **4** — **2 1** — **0** — **0** — **0** — **0** —

Series

3P (STD.) Miniature pushwheel

Number of Sections

- 0** Switch section
- 1** 1 Switch section
- 2** 2 Switch sections
- 3** 3 Switch sections
- 4** 4 Switch sections

Function Code

- 11** Decimal
- 21** BCD 1-2-4-8
- 23** Complement of BCD 1-2-4-8
- 65** SPDT repeating

Mounting Style

- 0** Snap-in, front mount
- 3** Snap-in, front mount

Terminations

- 0** (STD.) Short PCB
- 1** Extended PCB
- 3** Short PCB with solder pins
- 9** Any combination
- A** Extended PCB with solder pins
- L** Right angle, no components
- P** Right angle with solder pins
- W** Right angle PC board with provision for components
- Y** Right angle with solder pins

Color/Marking/Stops

- 0** Matte black housing, gloss black wheel, white marking, black pushbutton
- 1** Matte gray housing, gloss black wheel, white marking, black pushbutton
- 9** Combination of body colors, wheel colors, marking and/or stops

Dust Lens

- 0** (STD.) No lens
- 2** Dust lens

Illumination

- NONE** (STD.) No illumination
- 3** Red LED
- 5** Yellow LED
- 6** Green LED

Specifications

CONTACT RATING:
 CARRY: 1 AMP continuous.
 SWITCH: 0.4 VA max., 100 mA max., 28 V DC max.
 OPERATING VOLTAGE: 50 mV to 28 V DC.
 ELECTRICAL LIFE: 100,000 actuations.
 CONTACT RESISTANCE: Below 300 milliohms typ. @
 2-4 V DC, 100 mA.
 INSULATION RESISTANCE: 10⁹ ohms min. (dry).
 DIELECTRIC STRENGTH: 500 V RMS min. @ sea level
 between common terminal and any output.
 OPERATING TEMPERATURE: -10°C to 65°C.

Materials

HOUSING: Polycarbonate (UL 94V-0).
 PUSHWHEEL: Polycarbonate (UL 94V-0).
 PUSHBUTTON: Polycarbonate (UL 94V-0).
 ROTOR CONTACTS: Gold over nickel over copper alloy.
 STATOR CONTACTS: Hard gold over nickel over copper
 on epoxy fiberglass.
NOTE: Specifications and materials listed above are general specifications for switches
 with standard options. For information on specific and custom switches, consult Customer
 Service Center.

SERIES

3P (STD.) MINIATURE PUSHWHEEL SWITCH

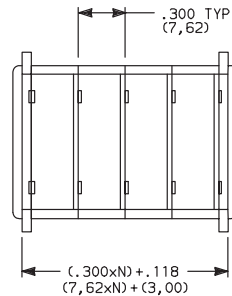
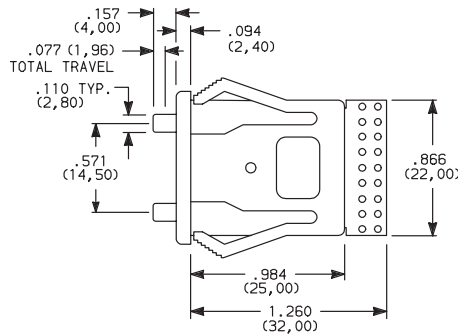
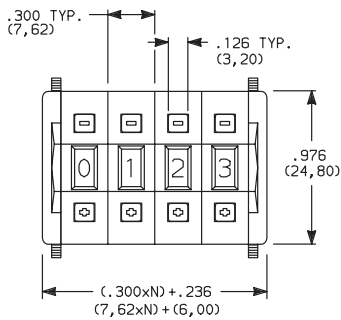

3P4210000

N = Number of sections.

PART NUMBER	NO. SECTIONS	NO. POSITIONS
3P4210000	4	10

NUMBER OF SECTIONS

- 0** Switch section only, no endplates.
- 1-4** Number of switch sections in assembly, includes endplates.

NOTE: Endplates and blank sections available separately, see section L.

FUNCTION CODE

11 DECIMAL, SP, 10 POSITION

WHEEL	SIGNALS CONNECTED TO COMMON SIGNAL C										C
	0	1	2	3	4	5	6	7	8	9	
0	●										●
1		●									●
2			●								●
3				●							●
4					●						●
5						●					●
6							●				●
7								●			●
8									●		●
9										●	●
	2	3	4	5	6	7	8	9	10	11	12
	TERM. LOCATION										

Available Terminations: L, P, W, Y
 See fig. 3, page J-21.

21 BCD 1-2-4-8, 10 POSITION

WHEEL	SIGNALS CONN. TO COMM. SIG. C				
	1	2	4	8	
0				●	
1	●			●	
2		●		●	
3	●	●		●	
4			●	●	
5	●		●	●	
6		●	●	●	
7	●	●	●	●	
8			●	●	
9	●		●	●	
	1	3	5	7	9
	TERM. LOCATION				

Available Terminations: A, L, P, W, Y, 0, 1, 3
 See figs. 2 & 3, page J-21.

23 COMPLEMENT OF BCD 1-2-4-8, 10 POSITION

WHEEL	SIGNALS CONN. TO COMM. SIG. C				
	1	2	4	8	
0	●	●	●	●	
1		●	●	●	
2	●		●	●	
3		●	●	●	
4	●	●		●	
5		●	●	●	
6	●		●	●	
7		●	●	●	
8	●	●	●	●	
9		●	●	●	
	1	7	9	3	5
	TERM. LOCATION				

Available Terminations: A, L, P, W, Y, 0, 1, 3
 See figs. 2 & 3, page J-21.

65 SPDT REPEATING, 10 POSITION ZERO (0) AND FIVE (5) ALTERNATING

WHEEL	SIG. CONN. TO C		
	0	5	
0	●	●	
1	●	●	
2	●	●	
3	●	●	
4	●	●	
5	●	●	
6	●	●	
7	●	●	
8	●	●	
9	●	●	
	3	5	7
	TERM. LOC.		

Available Terminations: A, L, P, W, Y, 0, 1, 3
 See figs. 2 & 3, page J-21.

NOTE: For terminal location diagrams, see page J-21.

Thumbwheel & Pushwheel

3P Series Miniature Pushwheel Switches



MOUNTING STYLE

0 SNAP-IN FRONT MOUNT,
SECTION PITCH: .300 (7,62) EACH SECTION

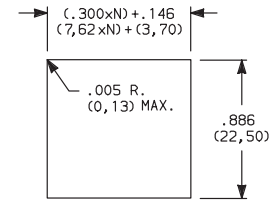
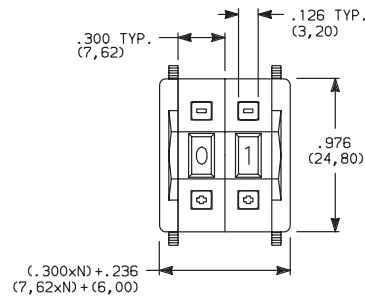

N = Number of sections.
Recommended panel thickness:
.039 - .156
(0,99 - 3,95)

3 SNAP-IN FRONT MOUNT WITH SPACER,
SECTION PITCH: .400 (70,16) EACH SECTION, LAST SECTION .300 (7,62)

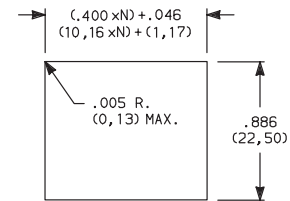
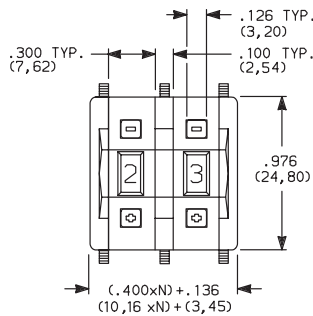

N = Number of sections.
Recommended panel thickness:
.039 - .156
(0,99 - 3,95)

TERMINATIONS

0 (STD.) SHORT PCB

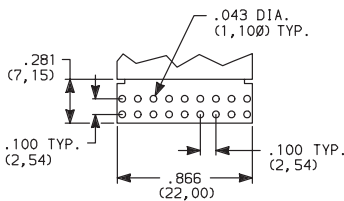

1 EXTENDED PCB WITH PROVISION
FOR COMPONENTS

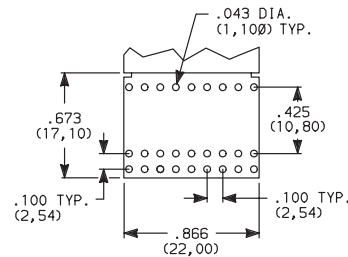

Signal traces cut, except for common(s).

3 SHORT PCB, TYPE 0 WITH SOLDER PINS

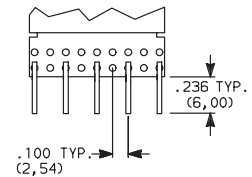

For terminal location numbers, see below.

A EXTENDED PCB, TYPE 1 WITH
SOLDER PINS

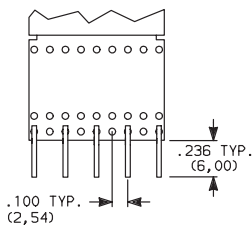

For terminal location numbers, see below.
Signal traces cut, except for common(s).

L RIGHT ANGLE, NO COMPONENTS

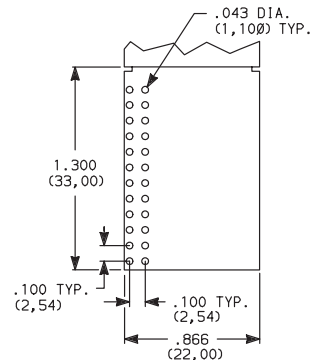

PC Board 1/32" (0,79) thick.

P RIGHT ANGLE, TYPE L WITH SOLDER PINS

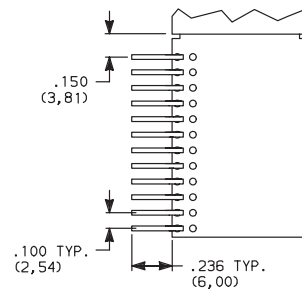

For terminal location numbers, see below.
Unsuitable for panel mounting.

NOTE: All terminal holes shown may not be present for all function codes,
consult Customer Service Center.

Thumbwheel & Pushwheel

TERMINATIONS

W RIGHT ANGLE PCB WITH PROVISION FOR COMPONENTS

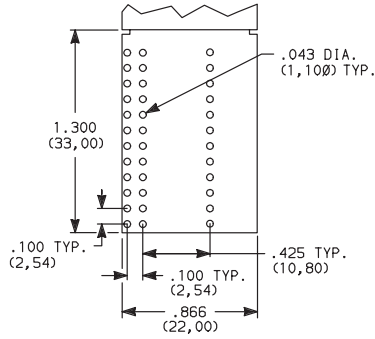

Y RIGHT ANGLE, TYPE WITH SOLDER PINS

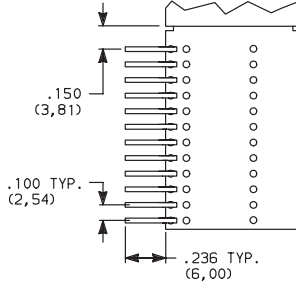

For terminal location numbers, see below.
Unsuitable for panel mounting.

9 ANY COMBINATION OF TERMINATION CONFIGURATIONS OR SPECIAL TERMINATIONS

Specify on configuration form, page J-22 and consult Customer Service Center.

Signal traces cut, except for common(s).

PC Board 1/32" (0,79) thick.

NOTE: All terminal holes shown may not be present for all function codes, consult Customer Service Center.

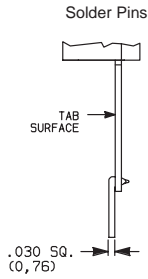

Fig. 1

Terminal Location Numbers

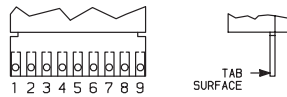

Fig. 2

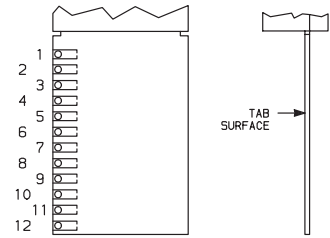

Fig. 3

COLOR/MARKING/STOPS

- 0** (STD.) MATTE BLACK HOUSING (Gloss black wheel with white characters, black pushbuttons, no stops.)
- 1** MATTE GRAY HOUSING (Gloss black wheel with white characters, black pushbuttons, no stops.)
- 9** SPECIAL COLORS, MARKINGS FOR HOUSING OR WHEEL, STOPS (Specify on CONFIGURATION FORM, page J-22 and consult Customer Service Center).

DUST LENS

- 0** (STD.) NO LENS
- 2** DUST LENS (Protects character face of the wheel from abrasion and dust.)

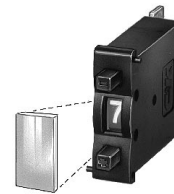

ILLUMINATION

- NONE** (STD.) NO ILLUMINATION
- 3** RED LED
- 5** YELLOW LED
- 6** GREEN LED

NOTE: Internal LED illuminates wheel character for low-light visibility.

3P Series Miniature Pushwheel Switches



Configuration Form

GRAY SHADED AREAS TO BE FILLED IN BY C&K.

C&K CATALOG PART NO.

3 P

C&K PART NUMBER

C&K PART NUMBER

COMPANY NAME _____

CUSTOMER
PRINT
REVISION:

ADDRESS _____ TEL.# _____

CUSTOMER CONTACT _____ DATE _____

DETAILS:

ORIGINATED BY _____ SALES REP. _____

Thumbwheel & Pushwheel

PUSHWHEEL SECTIONS	NO. OF SEC.	FUNCTION CODE — TERMINATIONS — COLOR/MARKING/STOPS/SEAL — ILLUMINATION <small>ENTER OPTION CODES IN APPROPRIATE BOXES. FUNCTION CODES INCLUDE BLANK SECTIONS (SEE CATALOG PAGE NO TAG).</small>	DESCRIBE IN APPROPRIATE ROW
<input type="checkbox"/> 1 <input type="checkbox"/>	1	3 P - <input type="text"/> <input type="text"/> - <input type="text"/> <input type="text"/> <input type="text"/> <input type="text"/>	
<input type="checkbox"/> 2 <input type="checkbox"/>	2	3 P - <input type="text"/> <input type="text"/> - <input type="text"/> <input type="text"/> <input type="text"/> <input type="text"/>	
<input type="checkbox"/> 3 <input type="checkbox"/>	3	3 P - <input type="text"/> <input type="text"/> - <input type="text"/> <input type="text"/> <input type="text"/> <input type="text"/>	
<input type="checkbox"/> 4 <input type="checkbox"/>	4	3 P - <input type="text"/> <input type="text"/> - <input type="text"/> <input type="text"/> <input type="text"/> <input type="text"/>	
<input type="checkbox"/> 5 <input type="checkbox"/>	5	3 P - <input type="text"/> <input type="text"/> - <input type="text"/> <input type="text"/> <input type="text"/> <input type="text"/>	
<input type="checkbox"/> 6 <input type="checkbox"/>	6	3 P - <input type="text"/> <input type="text"/> - <input type="text"/> <input type="text"/> <input type="text"/> <input type="text"/>	
<input type="checkbox"/> 7 <input type="checkbox"/>	7	3 P - <input type="text"/> <input type="text"/> - <input type="text"/> <input type="text"/> <input type="text"/> <input type="text"/>	
<input type="checkbox"/> 8 <input type="checkbox"/>	8	3 P - <input type="text"/> <input type="text"/> - <input type="text"/> <input type="text"/> <input type="text"/> <input type="text"/>	
<input type="checkbox"/> 9 <input type="checkbox"/>	9	3 P - <input type="text"/> <input type="text"/> - <input type="text"/> <input type="text"/> <input type="text"/> <input type="text"/>	
<input type="checkbox"/> 0 <input type="checkbox"/>	10	3 P - <input type="text"/> <input type="text"/> - <input type="text"/> <input type="text"/> <input type="text"/> <input type="text"/>	
<input type="checkbox"/> 1 <input type="checkbox"/>	11	3 P - <input type="text"/> <input type="text"/> - <input type="text"/> <input type="text"/> <input type="text"/> <input type="text"/>	

QUALITY CONTROL INSTRUCTIONS

PRODUCTION APPROVAL

DATE

Q.C. APPROVAL

DATE

REV.

INITIALS

DATE

FOR SWITCHES WITH MORE THAN 11 SECTIONS, CONTINUE ON ADDITIONAL SHEETS.

SPECIAL INSTRUCTIONS OR SPECIFICATIONS:

SHEET ____ OF ____