

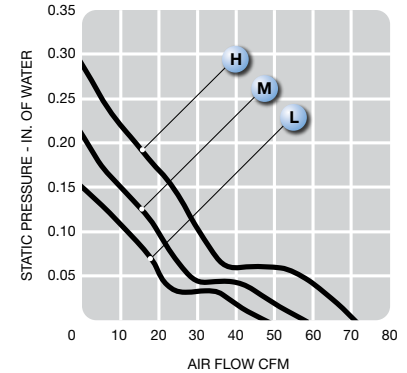

# LPH92A99 series

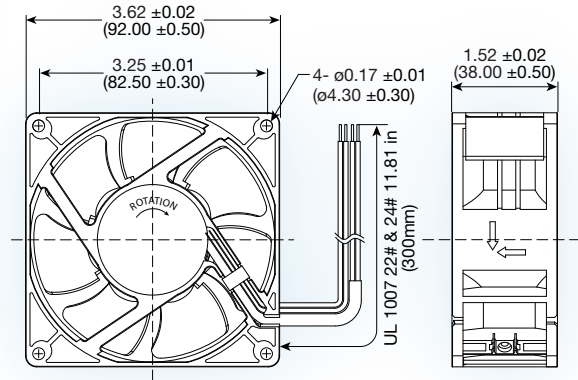

**(92 x 92 x 38 mm)**

3.62 x 3.62 x 1.52 inches

Operating voltage: 100 to 240 VAC

Construction: plastic frame and impeller

Bearing option: ball bearing

Motor: electronically commutated

Air flow: exhaust over struts

Connection: lead wire UL1007 24AWG  
or terminal

Protection: auto restart

Options: tachometer, PWM,  
environmental protection

Model No.	Rated Voltage V	Freq. HZ	Input Power W	Rated Cur. A	Speed RPM	Air Volume		Max. Static Pressure (H <sub>2</sub> O)		Sound Noise dB A	Weight g
						M <sup>3</sup> /Min.	CFM	MM	INCH		
LPH92A99-L	100-240	50/60	2.2	0.05	2500	1.3	48	3.8	0.15	31	174
LPH92A99-M	100-240	50/60	2.8	0.06	3000	1.6	58	5.3	0.21	37	174
LPH92A99-H	100-240	50/60	5.5	0.11	3500	1.9	68	7.4	0.29	42	174