

Printed-circuit board connector - TPC 16/ 9-ST-10,16 - 1715248

Please be informed that the data shown in this PDF Document is generated from our Online Catalog. Please find the complete data in the user's documentation. Our General Terms of Use for Downloads are valid (<http://phoenixcontact.com/download>)



Plug component, Nominal current: 76 A, Rated voltage (III/2): 1000 V, Number of positions: 9, Pitch: 10.16 mm, Connection method: Screw connection, Color: green, Contact surface: Silver

The figure shows a 5-pos. version of the product

Product Features

- ✓ Plug with double connection and a current carrying capacity of 76 A
- ✓ Simple potential distribution by means of two terminal points per contact
- ✓ Unlimited 600 V UL approval
- ✓ Maximum contact reliability due to integrated double steel spring
- ✓ CP-PC RD coding profile



Key commercial data

Packing unit	1 pc
Minimum order quantity	20 pc
Weight per Piece (excluding packing)	22.22 GRM
Custom tariff number	85366990
Country of origin	Germany

Technical data

Dimensions

Pitch	10.16 mm
Dimension a	81.28 mm

General

Range of articles	TPC 16/..-ST
Insulating material group	I
Rated surge voltage (III/3)	8 kV
Rated surge voltage (III/2)	8 kV

Printed-circuit board connector - TPC 16/ 9-ST-10,16 - 1715248

Technical data

General

Rated surge voltage (II/2)	6 kV
Rated voltage (III/3)	1000 V
Rated voltage (III/2)	1000 V
Rated voltage (II/2)	1000 V
Connection in acc. with standard	EN-VDE
Nominal current I_N	76 A
Nominal cross section	16 mm ²
Maximum load current	76 A
Insulating material	PA
Inflammability class according to UL 94	V0
Internal cylindrical gage	A6
Stripping length	18 mm
Number of positions	9
Screw thread	M4
Tightening torque, min	1.7 Nm
Tightening torque max	1.8 Nm

Connection data

Conductor cross section solid min.	0.75 mm ²
Conductor cross section solid max.	16 mm ²
Conductor cross section stranded min.	0.75 mm ²
Conductor cross section stranded max.	16 mm ²
Conductor cross section stranded, with ferrule without plastic sleeve min.	0.5 mm ²
Conductor cross section stranded, with ferrule without plastic sleeve max.	16 mm ² Only in connection with CRIMPFOX 16 S
Conductor cross section stranded, with ferrule with plastic sleeve min.	0.5 mm ²
Conductor cross section stranded, with ferrule with plastic sleeve max.	16 mm ² Only in connection with CRIMPFOX 16 S
Conductor cross section AWG/kcmil min.	18
Conductor cross section AWG/kcmil max	6
2 conductors with same cross section, solid min.	0.75 mm ²
2 conductors with same cross section, solid max.	6 mm ²
2 conductors with same cross section, stranded min.	0.75 mm ²
2 conductors with same cross section, stranded max.	6 mm ²
2 conductors with same cross section, stranded, ferrules without plastic sleeve, min.	0.5 mm ²
2 conductors with same cross section, stranded, ferrules without plastic sleeve, max.	4 mm ²
2 conductors with same cross section, stranded, TWIN ferrules with plastic sleeve, min.	0.5 mm ²

Printed-circuit board connector - TPC 16/ 9-ST-10,16 - 1715248

Technical data

Connection data

2 conductors with same cross section, stranded, TWIN ferrules with plastic sleeve, max.	6 mm ²
Minimum AWG according to UL/CUL	20
Maximum AWG according to UL/CUL	4

Classifications

eCl@ss

eCl@ss 4.0	272607xx
eCl@ss 4.1	27260701
eCl@ss 5.0	27260701
eCl@ss 5.1	27260701
eCl@ss 6.0	27260704
eCl@ss 7.0	27440402
eCl@ss 8.0	27440309

ETIM

ETIM 3.0	EC001121
ETIM 4.0	EC002638
ETIM 5.0	EC002638

UNSPSC

UNSPSC 6.01	30211810
UNSPSC 7.0901	39121409
UNSPSC 11	39121409
UNSPSC 12.01	39121409
UNSPSC 13.2	39121409

Approvals

Approvals

Approvals

UL Recognized / cUL Recognized / GOST / cULus Recognized

Ex Approvals

Printed-circuit board connector - TPC 16/ 9-ST-10,16 - 1715248

Approvals

Approvals submitted

Approval details

UL Recognized

	B	C
mm ² /AWG/kcmil	20-4	20-4
Nominal current I _N	60 A	60 A
Nominal voltage U _N	600 V	600 V

cUL Recognized

	B	C
mm ² /AWG/kcmil	20-4	20-4
Nominal current I _N	60 A	60 A
Nominal voltage U _N	600 V	600 V

GOST

cULus Recognized

Accessories

Accessories

Coding element

Coding profile - CP-PC RD - 1701967

Coding profile, for plugging into the coding ribs of the plug at a later date, insulating material, color: Red



Printed-circuit board connector - TPC 16/ 9-ST-10,16 - 1715248

Accessories

Additional products

Printed-circuit board connector - IPC 16/ 9-ST-10,16 - 1969441



Plug component, Nominal current: 76 A, Rated voltage (III/2): 1000 V, Number of positions: 9, Pitch: 10.16 mm, Connection method: Screw connection, Color: green, Contact surface: Silver

Printed-circuit board connector - ISPC 16/ 9-ST-10,16 - 1748613



Plug component, Nominal current: 76 A, Rated voltage (III/2): 1000 V, Number of positions: 9, Pitch: 10.16 mm, Connection method: Spring-cage connection, Color: green, Contact surface: Silver

Base strip - PC 6-16/ 9-G1-10,16 - 1996391



Header, Nominal current: 76 A, Rated voltage (III/2): 1000 V, Number of positions: 9, Pitch: 10.16 mm, Color: green, Contact surface: Silver, Assembly: Soldering

Base strip - PC 6-16/ 9-G1U-10,16 - 1996304



Header, Nominal current: 76 A, Rated voltage (III/2): 1000 V, Number of positions: 9, Pitch: 10.16 mm, Color: green, Contact surface: Silver, Assembly: Soldering

Base strip - PCV 6-16/ 9-G1-10,16 - 1998852



Header, Nominal current: 76 A, Rated voltage (III/2): 1000 V, Number of positions: 9, Pitch: 10.16 mm, Color: green, Contact surface: Silver, Assembly: Soldering

Printed-circuit board connector - TPC 16/ 9-ST-10,16 - 1715248

Accessories

Housing - DFK-PC 6-16/ 9-G-10,16 - 1701524



Header, Nominal current: 76 A, Rated voltage (III/2): 1000 V, Number of positions: 9, Pitch: 10.16 mm, Color: green, Contact surface: Silver, Assembly: Soldering

Base strip - DFK-PC 6-16/ 9-GU-10,16 - 1701689



Header, Nominal current: 76 A, Rated voltage (III/2): 1000 V, Number of positions: 9, Pitch: 10.16 mm, Color: green, Contact surface: Silver, Assembly: Soldering

Base strip - DFK-PCV 6-16/ 9-G-10,16 - 1702167



Header, Nominal current: 76 A, Rated voltage (III/2): 1000 V, Number of positions: 9, Pitch: 10.16 mm, Color: green, Contact surface: Silver, Assembly: Soldering

Printed-circuit board connector - DFK-PC 16/ 9-ST-10,16 - 1703441



Plug component, Nominal current: 76 A, Rated voltage (III/2): 1000 V, Number of positions: 9, Pitch: 10.16 mm, Connection method: Screw connection, Color: green, Contact surface: Silver

Drawings

Printed-circuit board connector - TPC 16/ 9-ST-10,16 - 1715248

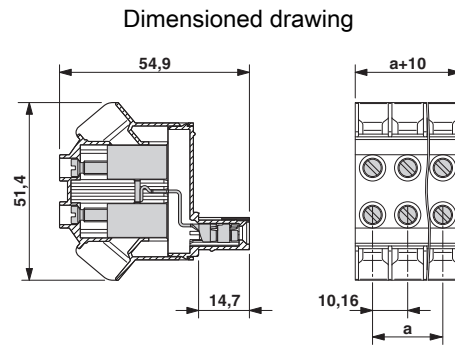
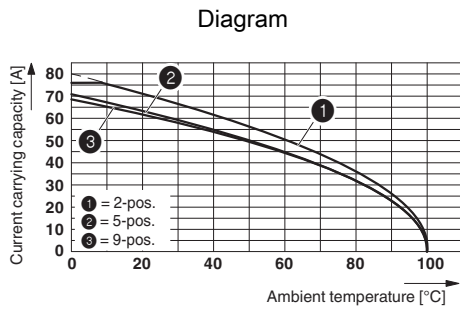

Derating curve for: TPC 16/....-ST-10,16 with PC 6-16/....-G-10,16