

LTC7810ELXE High Input Voltage Dual Output Synchronous Buck Converter

DESCRIPTION

Demonstration circuit 2529A is a dual output synchronous buck converter featuring the LTC[®]7810ELXE in a 48-lead eLQFP package.

Key features of this board include: an optional on-board NMOS LDO for DRVCC; jumper for spread-spectrum option; optional resistors for single output dual phase operation; a mode selector that allows the converter to run in CCM, pulse-skipping, adjustable burst clamp or default Burst Mode[®] operation; SYNC turret for PolyPhase[®] operation.

The input voltage range of this demo board is from 16V to 130V and it uses a sense resistor for overcurrent protection. The LTC7810 data sheet gives a complete description of the part, operation and application information and must be read in conjunction with this demo manual for DC2529A.

Design files for this circuit board are available at <http://www.analog.com/DC2529A>

LT, LT, LTC, LTM, Linear Technology, the Linear logo, Burst Mode and PolyPhase are registered trademarks of Analog Devices, Inc. All other trademarks are the property of their respective owners.

PERFORMANCE SUMMARY Specifications are at T_A = 25°C

Table 1.

PARAMETER	CONDITIONS	VALUE
Input Voltage Range		16V to 130V
Output Voltage V _{OUT1}	V _{IN} = 16V to 130V, I _{OUT1} = 0A to 10A, JP4: FCM	5V ± 2%
Output Voltage V _{OUT2}	V _{IN} = 16V to 130V, I _{OUT2} = 0A to 5A, JP4: FCM	12V ± 2%
Maximum Output Current I _{OUT1,MAX}	V _{IN} = 16V to 130V, I _{OUT1,MAX}	10A
Maximum Output Current I _{OUT2,MAX}	V _{IN} = 16V to 130V, I _{OUT2,MAX}	5A
Default Operating Frequency (Typical)		100kHz
External Clock Sync. Frequency Range		75kHz to 750kHz
Typical Full Load Efficiency (See Figure 4)	V _{IN} = 48V, V _{OUT1} = 5V, I _{OUT1} = 10A V _{IN} = 48V, V _{OUT2} = 12V, I _{OUT} = 5A	88.7% 95.4%

QUICK START PROCEDURE

Demonstration circuit DC2529A is easy to set up to evaluate the performance of the LTC7810ELXE. Refer to Figure 1 for proper measurement equipment setup and follow the procedure below:

NOTE: When measuring the input or output voltage ripple, care must be taken to avoid a long ground lead on the oscilloscope probe. Measure the input or output voltage ripple by touching the probe tip directly across the V_{IN} or V_{OUT} and GND terminals or directly across relevant capacitor. See Figure 2 for proper scope probe technique.

1. Place jumpers in the following positions:

JP1 OFF

JP2 ON

JP3 ON

JP4 FCM

JP5 ON

JP6 ON

2. With power off, connect the input power supply to V_{IN} and GND.

3. Turn on the power at the input.

NOTE: Make sure that the input voltage is higher than 16V and does not exceed 130V.

4. Check the output voltages. The output voltages should be within the specifications in Table 1.

Once the proper output voltages are established, adjust the load within the operating range and observe the output voltage regulation, output voltage ripple, efficiency and other parameters.

Note 1: If there is no output, temporarily disconnect the load to make sure that the load is not set too high.

Note 2: Do not apply load between the V_{OUT1}^+ and V_{OUT1}^- pins or between the V_{OUT2}^+ and V_{OUT2}^- pins. These pins are only intended to Kelvin sense the output voltage across the C27 and C24. Heavy load currents applied across the V_{OUT1}^+ , V_{OUT1}^- , V_{OUT2}^+ and V_{OUT2}^- sense pins will damage these sense traces.

QUICK START PROCEDURE

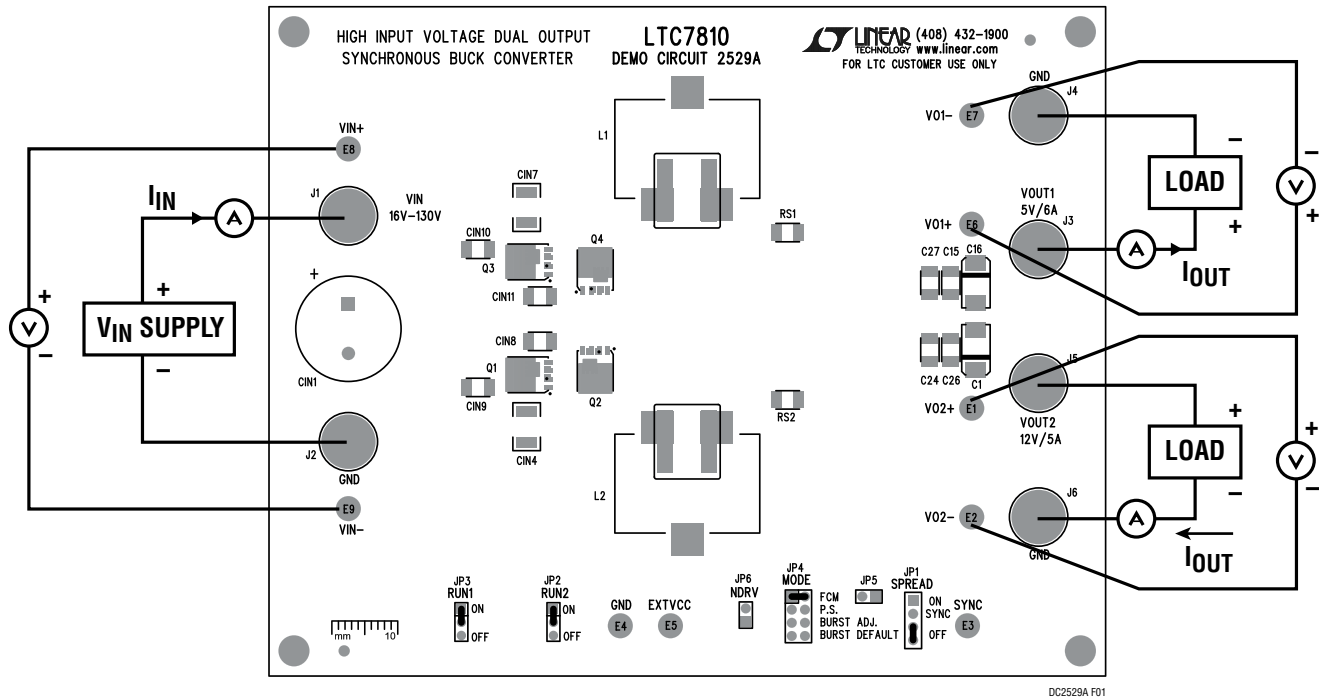

Figure 1. Proper Measurement Equipment Setup

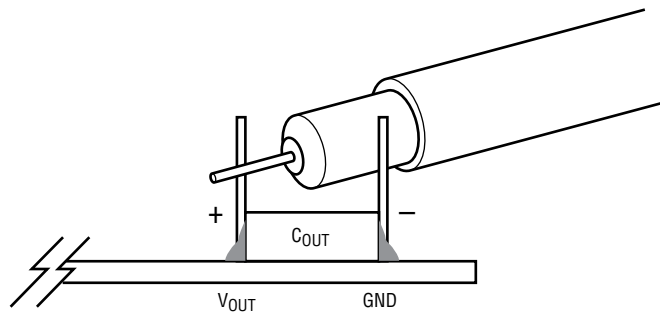

Figure 2. Measuring Input or Output Ripple Across Terminals or Directly Across Ceramic Capacitor

FREQUENCY SYNCHRONIZATION AND MODE SELECTION

Demonstration circuit 2529A's Mode selector allows the converter to run in forced continuous operation, pulse-skipping operation, Burst Mode operation or Burst Mode with adjustable clamp level by changing the position of

JP4. To synchronize the DC2529A to an external clock, apply the sync signal to the PLLIN turret. Depending upon the JP4 setting, the DC2529A will operate in different modes. See Table 2 for the detailed description.

Table 2. Mode Selection and Synchronized Operation Options

CONFIGURATION	JP4	MODE WITH SYNC. SIGNAL APPLIED TO PLLIN
Forced Continuous Operation	FCM	FCM
Pulse-Skipping Operation	PS.	PS.
Burst Mode Operation with Adjustable Clamp Level	BURST ADJ.	FCM
Burst Mode Operation with Default Clamp	BURST DEFAULT	FCM

SINGLE OUTPUT/DUAL PHASE OPERATION

A single output/dual phase converter may be preferred for high output current applications. The benefits of single output/dual phase operation is lower ripple current through the input and output capacitors, faster load step response and simplified thermal design. To implement single output/dual phase operation, make the following modifications:

- Tie V_{OUT1} to V_{OUT2} by tying together the exposed copper pads on the V_{OUT} shapes with pieces of heavy copper foil.
- Tie I_{TH1} to I_{TH2} by stuffing 0Ω at R43.
- Tie V_{FB1} to V_{FB2} by stuffing 0Ω at R45.
- Tie SS1 to SS2 by stuffing 0Ω at R44.
- Tie RUN1 to RUN2 by stuffing 0Ω at R42.
- Remove the redundant ITH compensation network, V_{FB} divider and SS cap.
- Replace C1, C16 if necessary.
- Re-compensate if necessary.

LOW QUIESCENT CURRENT APPLICATIONS AND MEASUREMENT

The typical quiescent current (I_Q) of the LTC7810 controller is $16\mu A$ in sleep mode as specified in the LTC7810 data sheet. However, the input current of the DC2529A board can be higher than this value because of additional circuit outside of the IC. To reduce the total input current,

large value FB divider resistors should be used. In addition, some jumpers and resistors should be configured accordingly. Refer to Table 3 for the low input quiescent current setup.

Table 3. Low Input Quiescent Current Configuration

Reference Designator	R39	R40	JP5	JP4	JP6	JP1
Function	OVLO	OVLO	INTV _{CC} Jumper	MODE Selector	NDRV Regulator	Spread Spectrum
Stuffing Option	OPEN	As-is	OPEN	BURST ADJ. or BURST DEFAULT	Short	OFF

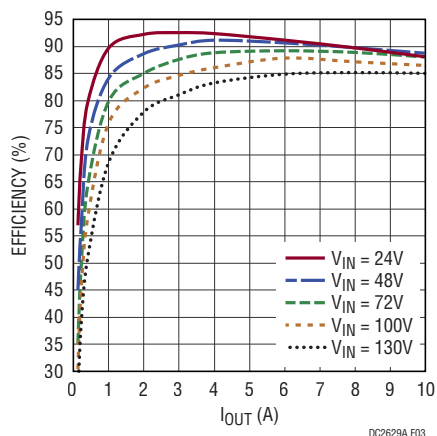

Figure 3. DC2529A V_{OUT1} Typical FCM Efficiency vs Load Current

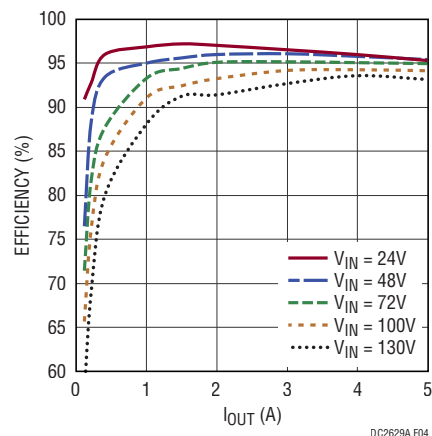

Figure 4. DC2529A V_{OUT2} Typical FCM Efficiency vs Load Current

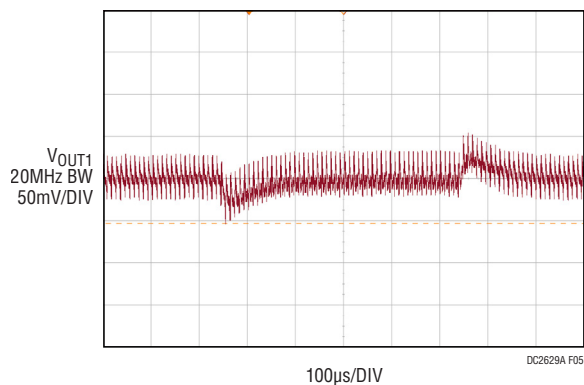

Figure 5. DC2529A V_{OUT1} 2.5A to 5A Load Transient at $V_{IN} = 48V$

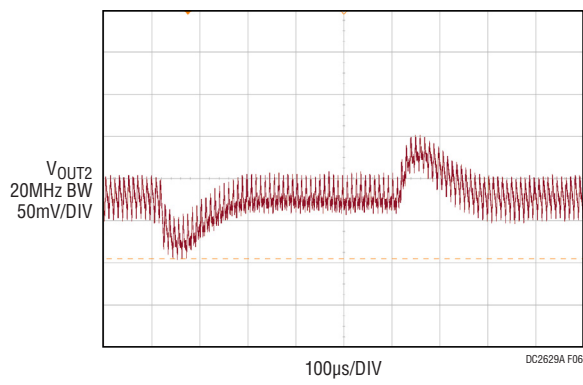

Figure 6. DC2529A V_{OUT2} 1.25A to 2.5A Load Transient at $V_{IN} = 48V$

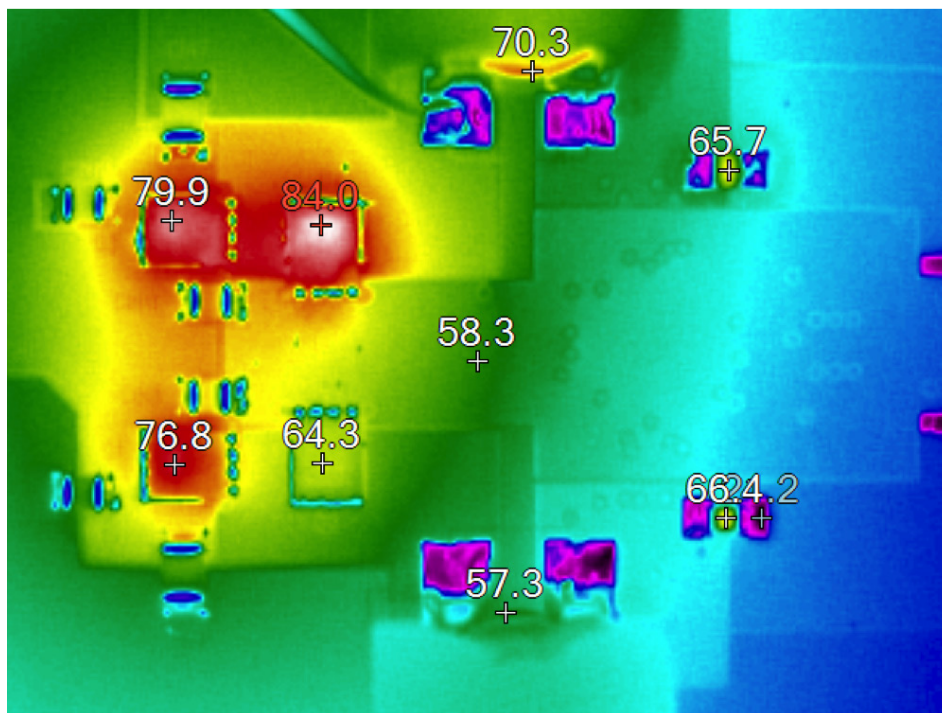

Figure 7. Thermal Image V_{IN} 130V, V_{OUT1} 5V at 10A, V_{OUT2} 12V at 5A No Air Flow, $T_A = 25^\circ\text{C}$

PARTS LIST

ITEM	QTY	REFERENCE	PART DESCRIPTION	MANUFACTURER/PART NUMBER
Required Circuit Components				
1	1	CIN1	CAP, 100µF, 200V, 20%, CAPNIC\16X20	NIC, NRB-XS101M200V16X20F
2	4	CIN4, CIN5, CIN6, CIN7	CAP, 0.47µF, 200V, 10%, 1812	MURATA, GRM43DR72E474KW01L
3	4	CIN8, CIN9, CIN10, CIN11	CAP, 0.1µF, X7R, 200V, 10%, 1210	MURATA, GRM32DR72D104KW01L
4	1	C1	CAP, POSCAP, 150µF, 16V, 7343	PANASONIC, 16TQC150MYF
5	2	C7, C19	CAP, 0.01µF, X7R, 100V, 10%, 0603	MURATA, GRM188R72A103KA01D
6	2	C8, C9	CAP, 10pF, NPO, 100V, 5%, 0603	MURATA, GRM1885C2A100JA01D
7	2	C10, C13	CAP, 4700pF, COG, 50V, 5%, 0603	MURATA, GRM1885C1H472JA01D
8	2	C11, C14	CAP, 100pF, NPO, 100V, 5%, 0603	MURATA, GRM1885C2A101JA01D
9	2	C12, C20	CAP, 1000pF, NPO, 50V, 5%, 0603	MURATA, GRM1885C1H102JA01D
10	1	C16	CAP, POSCAP, 470µF, 6.3V, 7343	PANASONIC, 6TPE470M
11	2	C18, C25	CAP, 0.1µF, X7R, 100V, 10%, 0603	MURATA, GRM188R72A104KA35D
12	2	C21, C35	CAP, 4.7µF, X7R, 16V, 10%, 0805	MURATA, GRM21BR71C475KE51L
13	2	C24, C27	CAP, X5R, 10µF, 35V, 20%, 1210	MURATA, GRM32ER6YA106MA12L
14	1	C34	CAP, 0.033µF, X7R, 200V, 10%, 1206	MURATA, GRM31CR72D333KW03L
15	1	C36	CAP, 0.33µF, X7R, 16V, 10%, 0603	MURATA, GRM188R71C334KA01D
16	2	D3, D4	DIODE, SCHOTTKY 150V SOD-123	CENTRAL SEMI., CMHD3595 TR
17	1	L1	IND., PWR., 15µH, 15%	WURTH ELEKTRONIK, 7443631500
18	1	L2	IND., PWR., 47µH, 15%	WURTH ELEKTRONIK, 7443634700
19	3	Q1, Q3, Q7	XSTR., MOSFET, N-CH, 150V, 21A, TDSON-8	INFINEON, BSC520N15NS3G
20	2	Q2, Q4	XSTR., MOSFET, N-CH, 150V, 56A, TDSON-8	BSC160N15NS5ATMA1
21	1	Q9	XSTR., MOSFET, N-CH, 150V, 1.5A, TDSON-8	VISHAY, SI3440DV-T1-E3
22	1	RS1	SENSE RES., 0.004Ω, 1%, 1/4W,1210	VISHAY, WSL12104L000FEA
23	1	RS2	SENSE RES., 0.01Ω, 1%, 1/4W, 1210	VISHAY, WSL1210R0100FEA
24	1	R3	RES., 2.2 1% 1206	VISHAY, CRCW12062R20FKEA
25	1	R8	RES., 2.2M, 1/10W, 1%, 0603	VISHAY, CRCW06032M20FKEA
26	1	R9	RES., 2.67M, 1/10W, 1%, 0603	VISHAY, CRCW06032M67FKEA
27	2	R10, R15	RES., 4.99k, 1/10W, 1%, 0603	VISHAY, CRCW06034K99FKEA
28	1	R11	RES., 200k, 1/10W, 1%, 0603	VISHAY, CRCW0603200KFKEA
29	1	R12	RES., 665k, 1/10W, 1%, 0603	VISHAY, CRCW0603665KFKEA
30	2	R14, R21	RES., 100, 1/10W, 1%, 0603	VISHAY, CRCW0603100RFKEA
31	1	R18	RES., 24.3k, 1/10W, 1%, 0603	VISHAY, CRCW060324K3FKEA
32	2	R22, R23	RES., 1M, 1/10W, 1%, 0805	VISHAY, CRCW08051M00FKEA
33	2	R29, R30	RES., 2.2, 1/10W, 1% 0603	VISHAY, CRCW06032R20FKEA
34	2	R34, R36	RES., 100k, 1/10W, 1%, 0603	VISHAY, CRCW0603100KFKEA
35	1	R35	RES., 10k, 1/10W, 1%, 0603	VISHAY, CRCW060310K0FKEA
36	1	R40	RES., 1k, 1/10W, 1%, 0603	VISHAY, CRCW06031K00FKEA
37	1	U1	I.C., LTC7810ELXE#PBF, LQFP-7X7	LINEAR TECH., LTC7810ELXE#PBF

DEMO MANUAL DC2529A

PARTS LIST

ITEM	QTY	REFERENCE	PART DESCRIPTION	MANUFACTURER/PART NUMBER
Additional Demo Board Circuit Components				
1	0	C17, C23, C28, C32, C33	CAP., OPTION, 0603	OPT
2	0	C15, C26	CAP., OPTION, 1210	OPT
3	0	C30	CAP., OPTION, 0805	OPT
4	0	D1, D2	DIODE, OPTION, DI-123	OPT
5	0	Q5, Q6, Q8	XSTR., OPTION	OPT
6	7	R1, R4, R5, R13, R20, R28, R38	RES., 0 Ω , 1/10W, 0603	VISHAY, CRCW06030000Z0EA
7	0	R6, R7, R16, R17, R26, R27, R31, R33, R37, R41-R45	RES., OPTION, 0603	OPT.
8	0	R39	RES., OPTION, 0805	OPT.
Hardware: For Demo Board Only				
1	9	E1-E9	TEST POINT, TURRET, .094" MTG. HOLE	MILL-MAX, 2501-2-00-80-00-00-07-0
2	6	J1, J2, J3, J4, J5, J6	CONN., BANANA JACK	KEYSTONE, 575-4
3	1	JP1	HEADER, 1 \times 4, 2MM	WURTH ELEKTRONIK, 62000411121
4	2	JP2, JP3	HEADER, 1 \times 3, 2MM	WURTH ELEKTRONIK, 62000311121
5	1	JP4	HEADER, 2 \times 4, 2MM	WURTH ELEKTRONIK, 62000821121
6	2	JP5, JP6	HEADER, 1 \times 2, 2MM	WURTH ELEKTRONIK, 62000211121
7	4	XJP1, XJP2, XJP3, XJP4	SHUNT, 2MM	WURTH ELEKTRONIK, 60800213421
8	4	MTG1-MTG4	STANDOFF, NYLON, SNAP-ON, .500" TALL	WURTH ELEKTRONIK, 702935000

SCHEMATIC DIAGRAM

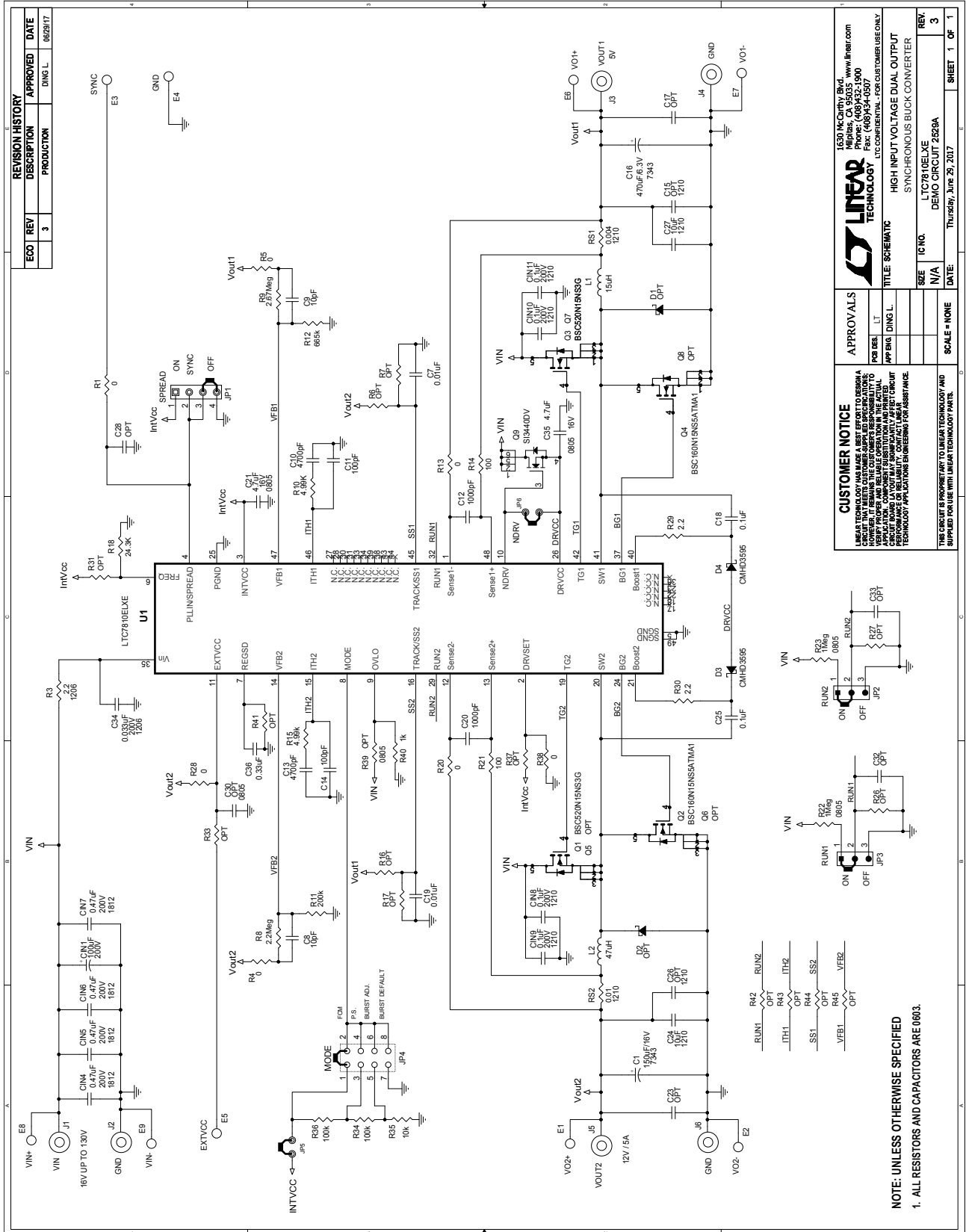



ESD Caution

ESD (electrostatic discharge) sensitive device. Charged devices and circuit boards can discharge without detection. Although this product features patented or proprietary protection circuitry, damage may occur on devices subjected to high energy ESD. Therefore, proper ESD precautions should be taken to avoid performance degradation or loss of functionality.

Legal Terms and Conditions

By using the evaluation board discussed herein (together with any tools, components documentation or support materials, the "Evaluation Board"), you are agreeing to be bound by the terms and conditions set forth below ("Agreement") unless you have purchased the Evaluation Board, in which case the Analog Devices Standard Terms and Conditions of Sale shall govern. Do not use the Evaluation Board until you have read and agreed to the Agreement. Your use of the Evaluation Board shall signify your acceptance of the Agreement. This Agreement is made by and between you ("Customer") and Analog Devices, Inc. ("ADI"), with its principal place of business at One Technology Way, Norwood, MA 02062, USA. Subject to the terms and conditions of the Agreement, ADI hereby grants to Customer a free, limited, personal, temporary, non-exclusive, non-sublicensable, non-transferable license to use the Evaluation Board FOR EVALUATION PURPOSES ONLY. Customer understands and agrees that the Evaluation Board is provided for the sole and exclusive purpose referenced above, and agrees not to use the Evaluation Board for any other purpose. Furthermore, the license granted is expressly made subject to the following additional limitations: Customer shall not (i) rent, lease, display, sell, transfer, assign, sublicense, or distribute the Evaluation Board; and (ii) permit any Third Party to access the Evaluation Board. As used herein, the term "Third Party" includes any entity other than ADI, Customer, their employees, affiliates and in-house consultants. The Evaluation Board is NOT sold to Customer; all rights not expressly granted herein, including ownership of the Evaluation Board, are reserved by ADI. CONFIDENTIALITY. This Agreement and the Evaluation Board shall all be considered the confidential and proprietary information of ADI. Customer may not disclose or transfer any portion of the Evaluation Board to any other party for any reason. Upon discontinuation of use of the Evaluation Board or termination of this Agreement, Customer agrees to promptly return the Evaluation Board to ADI. ADDITIONAL RESTRICTIONS. Customer may not disassemble, decompile or reverse engineer chips on the Evaluation Board. Customer shall inform ADI of any occurred damages or any modifications or alterations it makes to the Evaluation Board, including but not limited to soldering or any other activity that affects the material content of the Evaluation Board. Modifications to the Evaluation Board must comply with applicable law, including but not limited to the RoHS Directive. TERMINATION. ADI may terminate this Agreement at any time upon giving written notice to Customer. Customer agrees to return to ADI the Evaluation Board at that time. LIMITATION OF LIABILITY. THE EVALUATION BOARD PROVIDED HEREUNDER IS PROVIDED "AS IS" AND ADI MAKES NO WARRANTIES OR REPRESENTATIONS OF ANY KIND WITH RESPECT TO IT. ADI SPECIFICALLY DISCLAIMS ANY REPRESENTATIONS, ENDORSEMENTS, GUARANTEES, OR WARRANTIES, EXPRESS OR IMPLIED, RELATED TO THE EVALUATION BOARD INCLUDING, BUT NOT LIMITED TO, THE IMPLIED WARRANTY OF MERCHANTABILITY, TITLE, FITNESS FOR A PARTICULAR PURPOSE OR NON-INFRINGEMENT OF INTELLECTUAL PROPERTY RIGHTS. IN NO EVENT WILL ADI AND ITS LICENSORS BE LIABLE FOR ANY INCIDENTAL, SPECIAL, INDIRECT, OR CONSEQUENTIAL DAMAGES RESULTING FROM CUSTOMER'S POSSESSION OR USE OF THE EVALUATION BOARD, INCLUDING BUT NOT LIMITED TO LOST PROFITS, DELAY COSTS, LABOR COSTS OR LOSS OF GOODWILL. ADI'S TOTAL LIABILITY FROM ANY AND ALL CAUSES SHALL BE LIMITED TO THE AMOUNT OF ONE HUNDRED US DOLLARS (\$100.00). EXPORT. Customer agrees that it will not directly or indirectly export the Evaluation Board to another country, and that it will comply with all applicable United States federal laws and regulations relating to exports. GOVERNING LAW. This Agreement shall be governed by and construed in accordance with the substantive laws of the Commonwealth of Massachusetts (excluding conflict of law rules). Any legal action regarding this Agreement will be heard in the state or federal courts having jurisdiction in Suffolk County, Massachusetts, and Customer hereby submits to the personal jurisdiction and venue of such courts. The United Nations Convention on Contracts for the International Sale of Goods shall not apply to this Agreement and is expressly disclaimed.