

# IRF7324D1PbF

FETKY™ MOSFET / Schottky Diode

- Co-packaged HEXFET® Power MOSFET and Schottky Diode
- Ideal for Mobile Phone Applications
- Generation V Technology
- SO-8 Footprint
- Lead-Free

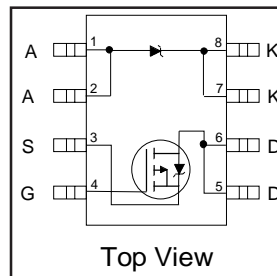

$V_{DSS} = -20V$
$R_{DS(on)} = 0.27\Omega$
Schottky $V_f = 0.39V$

## Description

The FETKY™ family of co-packaged HEXFETs and Schottky diodes offer the designer an innovative board space saving solution for switching regulator applications. Generation 5 HEXFETs utilize advanced processing techniques to achieve extremely low on-resistance per silicon area. Combining this technology with International Rectifier's low forward drop Schottky rectifiers results in an extremely efficient device suitable for use in a wide variety of portable electronics applications.

The SO-8 has been modified through a customized leadframe for enhanced thermal characteristics. The SO-8 package is designed for vapor phase, infrared or wave soldering techniques.

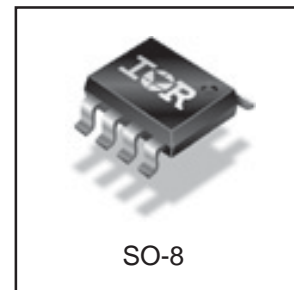

## Absolute Maximum Ratings

	Parameter	Max.	Units
$V_{DS}$	Drain-to-Source Voltage	-20	V
$V_{GS}$	Gate-to-Source Voltage	$\pm 12$	
$I_D @ T_A = 25^\circ C$	Continuous Drain Current, $V_{GS} @ 10V$	-2.2	A
$I_D @ T_A = 70^\circ C$	Continuous Drain Current, $V_{GS} @ 10V$	-1.8	
$I_{DM}$	Pulsed Drain Current ①	-22	
$P_D @ T_A = 25^\circ C$	Power Dissipation ④	2.0	W
$P_D @ T_A = 70^\circ C$	Power Dissipation ④	1.3	
dV/dt	Peak Diode Recovery ②	-0.74	V/ns
	Linear Derating Factor	16	mW/°C
$T_J$	Operating Junction and	-55 to + 150	°C
$T_{STG}$	Storage Temperature Range		

## Thermal Resistance

	Parameter	Typ.	Max.	Units
$R_{\theta JL}$	Junction-to-Drain Lead ⑤	—	20	°C/W
$R_{\theta JA}$	Junction-to-Ambient ④⑤	—	62.5	

Notes ① through ⑤ are on page 8  
[www.irf.com](http://www.irf.com)

# IRF7324D1PbF

International  
 Rectifier

## MOSFET Electrical Characteristics @ T<sub>J</sub> = 25°C (unless otherwise specified)

	Parameter	Min.	Typ.	Max.	Units	Conditions
BV <sub>DSS</sub>	Drain-to-Source Breakdown Voltage	-20	—	—	V	V <sub>GS</sub> = 0V, I <sub>D</sub> = -250μA
R <sub>DS(on)</sub>	Static Drain-to-Source On-Resistance	—	0.155	0.270	Ω	V <sub>GS</sub> = -4.5V, I <sub>D</sub> = -1.2A ③
		—	0.260	0.400		V <sub>GS</sub> = -2.7V, I <sub>D</sub> = -0.6A ③
V <sub>GS(th)</sub>	Gate Threshold Voltage	-0.70	—	—	V	V <sub>DS</sub> = V <sub>GS</sub> , I <sub>D</sub> = -250μA
I <sub>DSS</sub>	Drain-to-Source Leakage Current	—	—	-1.0	μA	V <sub>DS</sub> = -16V, V <sub>GS</sub> = 0V
		—	—	-25		V <sub>DS</sub> = -16V, V <sub>GS</sub> = 0V, T <sub>J</sub> = 125°C
I <sub>GSS</sub>	Gate-to-Source Forward Leakage	—	—	100	nA	V <sub>DS</sub> = -12V
	Gate-to-Source Reverse Leakage	—	—	-100		V <sub>GS</sub> = 12V
g <sub>fs</sub>	Forward Transconductance	2.4	—	—	S	V <sub>DS</sub> = -16V, I <sub>D</sub> = -2.2A
Q <sub>g</sub>	Total Gate Charge	—	5.2	7.8	nC	I <sub>D</sub> = -2.2A
Q <sub>gs</sub>	Gate-to-Source Charge	—	0.88	—		V <sub>GS</sub> = -4.5V
Q <sub>gd</sub>	Gate-to-Drain Charge	—	2.5	—		V <sub>DD</sub> = -16V
t <sub>d(on)</sub>	Turn-On Delay Time	—	10	—	ns	V <sub>DD</sub> = -10V, V <sub>GS</sub> = -4.5V ③
t <sub>r</sub>	Rise Time	—	12	—		I <sub>D</sub> = -2.2A
t <sub>d(off)</sub>	Turn-Off Delay Time	—	11	—		R <sub>G</sub> = 6.0Ω
t <sub>f</sub>	Fall Time	—	7.6	—		R <sub>D</sub> = 4.5Ω
C <sub>iss</sub>	Input Capacitance	—	260	—	pF	V <sub>GS</sub> = 0V
C <sub>oss</sub>	Output Capacitance	—	140	—		V <sub>DS</sub> = -15V
C <sub>rss</sub>	Reverse Transfer Capacitance	—	70	—		f = 1.0MHz

## MOSFET Source-Drain Ratings and Characteristics

	Parameter	Min.	Typ.	Max.	Units	Conditions
I <sub>S</sub>	Continuous Source Current	—	—	-2.2		
I <sub>SM</sub>	Pulsed Source Current	—	—	-22		
V <sub>SD</sub>	Diode Forward Voltage	—	—	-1.2	V	T <sub>J</sub> = 25°C, I <sub>S</sub> = -2.2A, V <sub>GS</sub> = 0V ③
t <sub>rr</sub>	Reverse Recovery Time	—	26	39	ns	T <sub>J</sub> = 25°C, I <sub>F</sub> = -2.2A, V <sub>DD</sub> = -10V
Q <sub>rr</sub>	Reverse Recovery Charge	—	24	36	nC	di/dt = 100A/μs ③

## Schottky Diode Maximum Ratings

	Parameter	Max.	Units	Conditions	
I <sub>F(av)</sub>	Max. Average Forward current	1.7	A	50% Duty Cycle Rectangular Wave, T <sub>A</sub> = 25°C	
		1.2		T <sub>A</sub> = 70°C	
I <sub>SM</sub>	Max. Peak one cycle Non-repetitive Surge Current	120		5μs sine or 3μs Rect. Pulse	Following any rated load condition & with VRRM applied
		11		10ms sine or 6ms Rect. Pulse	

## Schottky Diode Electrical Specifications

	Parameter	Max.	Units	Conditions	
V <sub>FM</sub>	Max. Forward Voltage Drop	0.50	V	I <sub>F</sub> = 1.0A, T <sub>J</sub> = 25°C	
		0.62		I <sub>F</sub> = 2.0A, T <sub>J</sub> = 25°C	
		0.39		I <sub>F</sub> = 1.0A, T <sub>J</sub> = 125°C	
		0.57		I <sub>F</sub> = 2.0A, T <sub>J</sub> = 125°C	
I <sub>RM</sub>	Max. Reverse Leakage Current	0.05	mA	V <sub>R</sub> = 20V	T <sub>J</sub> = 25°C
		10			T <sub>J</sub> = 125°C
C <sub>t</sub>	Max. Junction Capacitance	92	pF	V <sub>R</sub> = 5Vdc (100kHz to 1MHz) 25°C	
dV/dt	Max. Voltage Rate of Charge	3600	V/μs	Rated V <sub>R</sub>	

Power Mosfet Characteristics

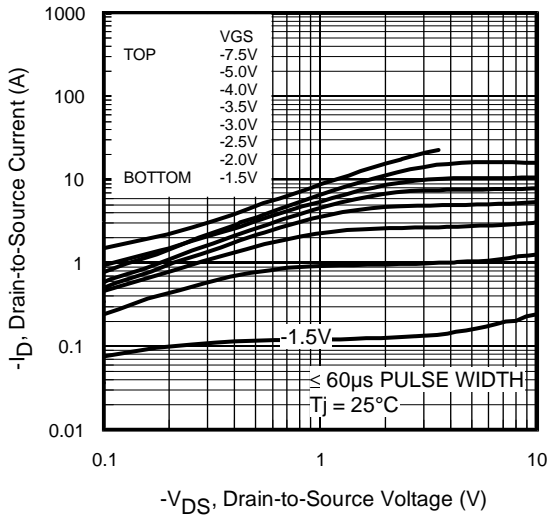

Fig 1. Typical Output Characteristics

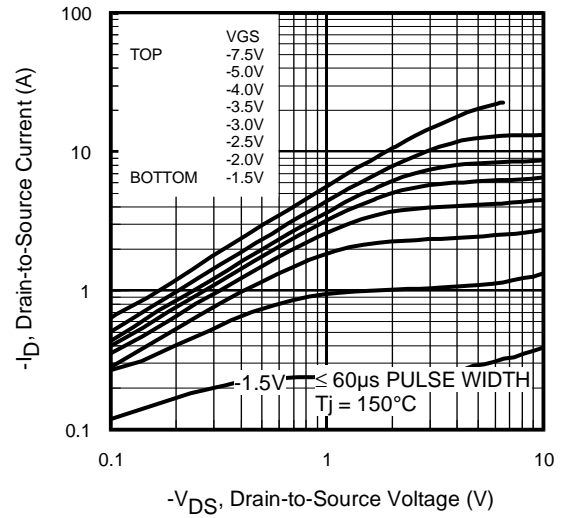

Fig 2. Typical Output Characteristics

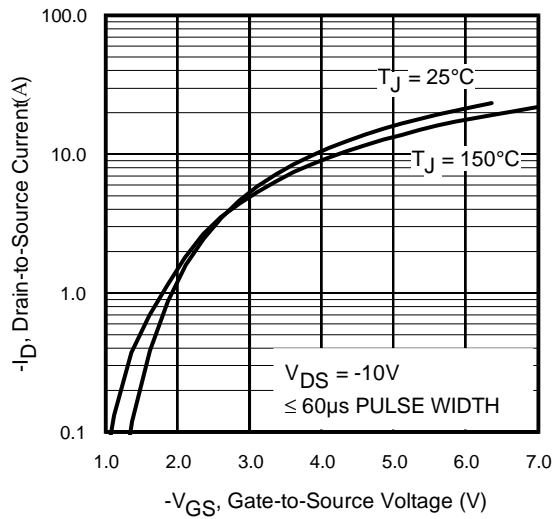

Fig 3. Typical Transfer Characteristics

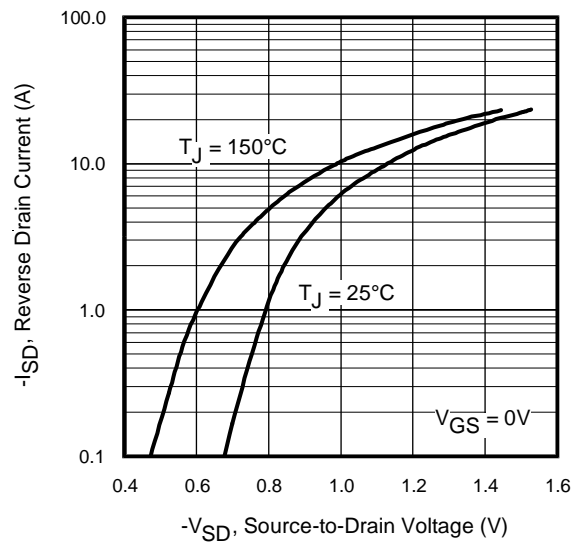

Fig 4. Typical Source-Drain Diode Forward Voltage

Power Mosfet Characteristics

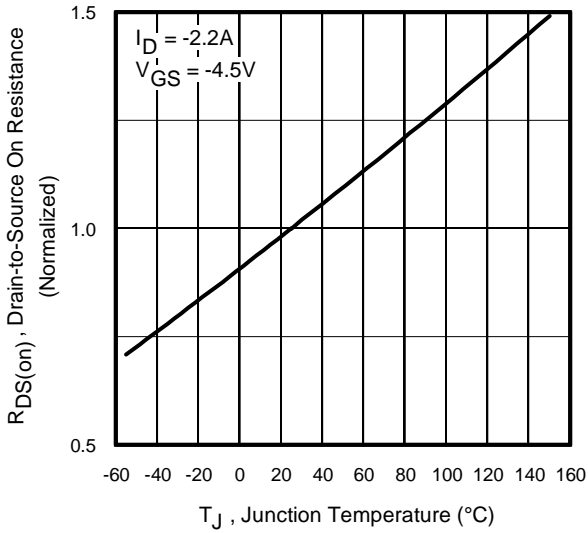

Fig 5. Normalized On-Resistance Vs. Temperature

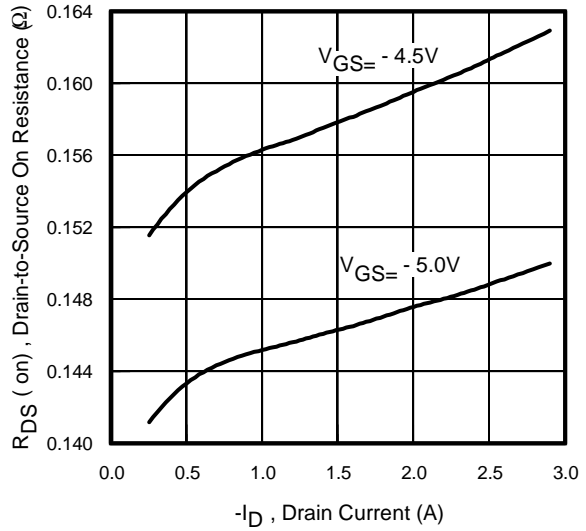

Fig 6. Typical On-Resistance Vs. Drain Current

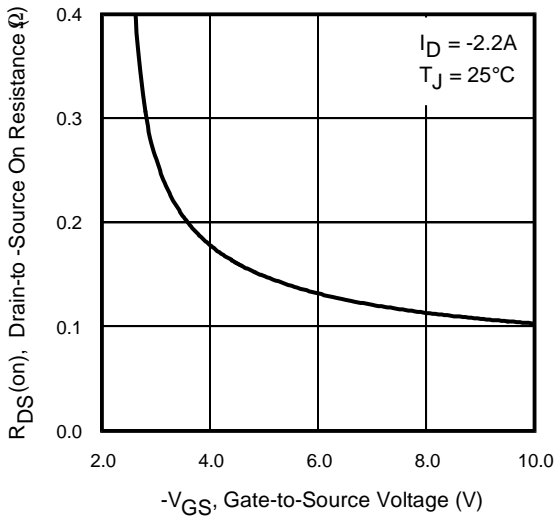

Fig 7. Typical On-Resistance Vs. Gate Voltage

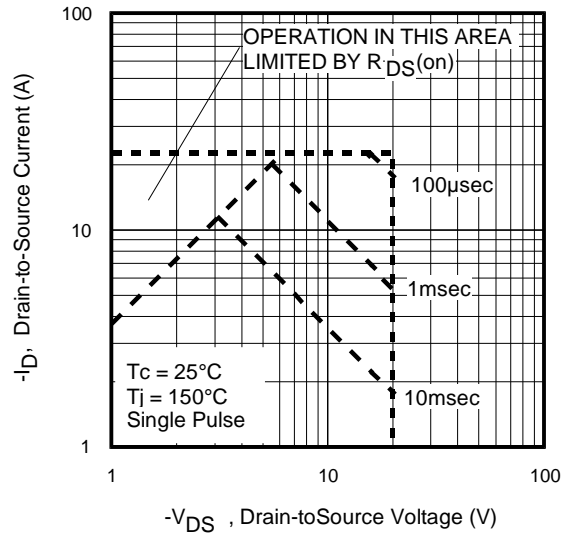

Fig 8. Maximum Safe Operating Area

Power Mosfet Characteristics

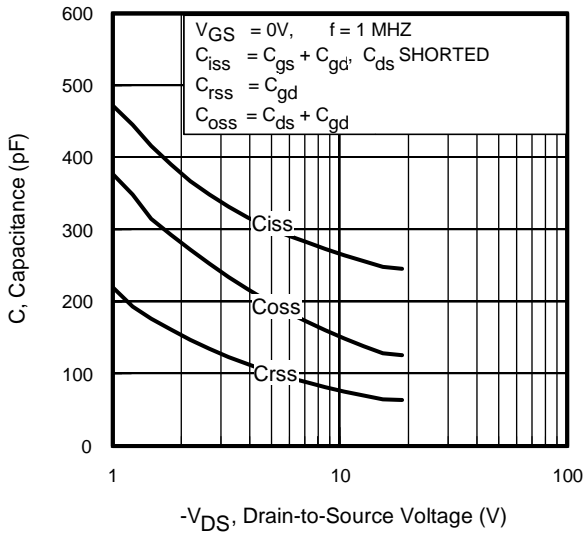

Fig 9. Typical Capacitance Vs. Drain-to-Source Voltage

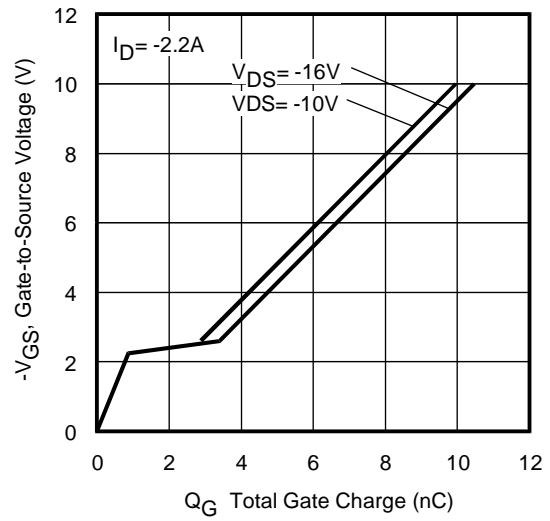

Fig 10. Typical Gate Charge Vs. Gate-to-Source Voltage

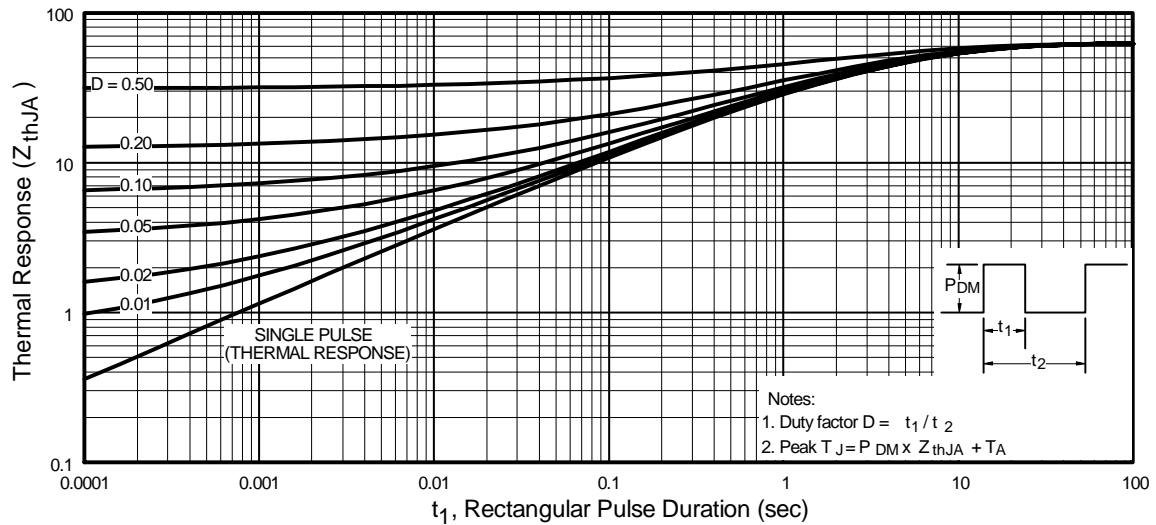

Fig 11. Maximum Effective Transient Thermal Impedance, Junction-to-Ambient

Schottky Diode Characteristics

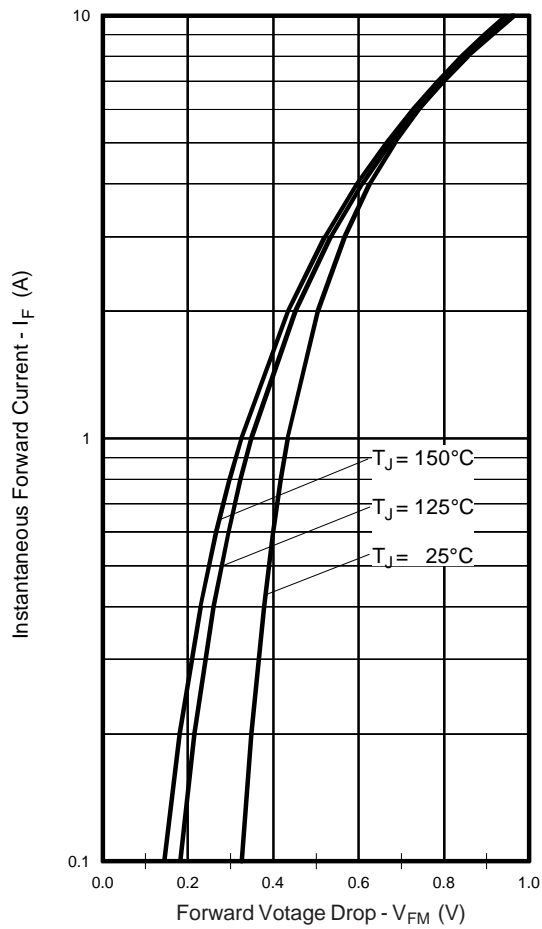

Fig. 12 -Typical Forward Voltage Drop Characteristics

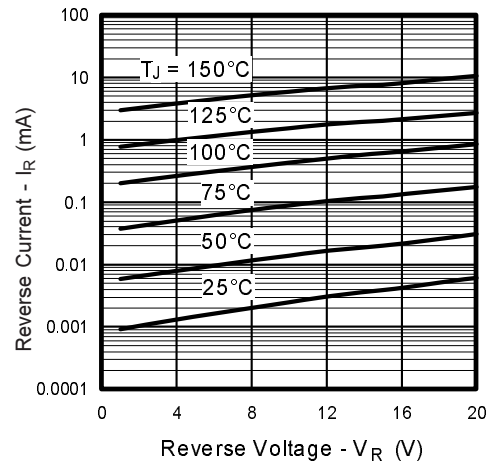

Fig. 13 - Typical Values of Reverse Current Vs. Reverse Voltage

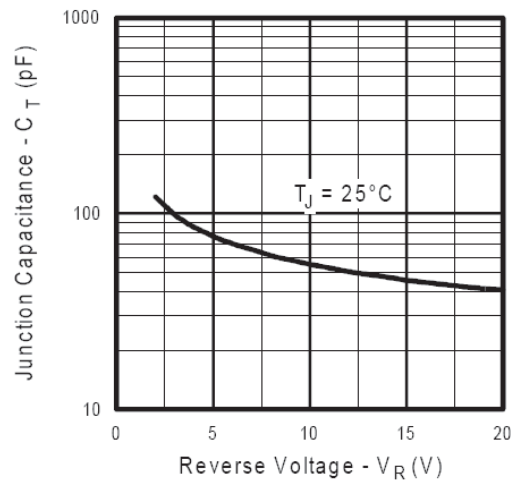
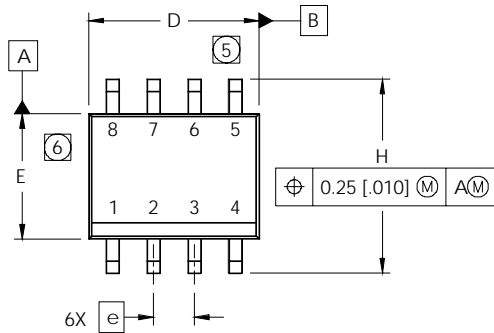
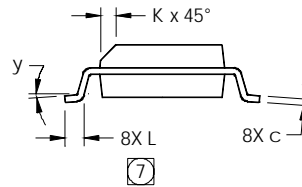
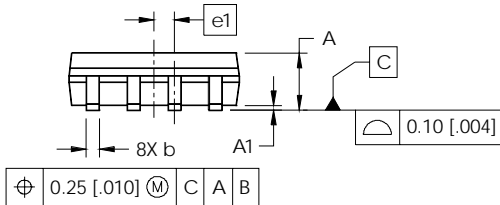

Fig.14 - Typical Junction capacitance Vs.Reverse Voltage

**SO-8 (Fetky) Package Outline** (Dimensions are shown in millimeters (inches) )



DIM	INCHES		MILLIMETERS	
	MIN	MAX	MIN	MAX
A	.0532	.0688	1.35	1.75
A1	.0040	.0098	0.10	0.25
b	.013	.020	0.33	0.51
c	.0075	.0098	0.19	0.25
D	.189	.1968	4.80	5.00
E	.1497	.1574	3.80	4.00
e	.050 BASIC		1.27 BASIC	
e1	.025 BASIC		0.635 BASIC	
H	.2284	.2440	5.80	6.20
K	.0099	.0196	0.25	0.50
L	.016	.050	0.40	1.27
y	0°	8°	0°	8°



NOTES:

1. DIMENSIONING & TOLERANCING PER ASME Y14.5M-1994.
2. CONTROLLING DIMENSION: MILLIMETER
3. DIMENSIONS ARE SHOWN IN MILLIMETERS [INCHES].
4. OUTLINE CONFORMS TO JEDEC OUTLINE MS-012AA
- ⑤ DIMENSION DOES NOT INCLUDE MOLD PROTRUSIONS. MOLD PROTRUSIONS NOT TO EXCEED 0.15 [0.006].
- ⑥ DIMENSION DOES NOT INCLUDE MOLD PROTRUSIONS. MOLD PROTRUSIONS NOT TO EXCEED 0.25 [0.010].
- ⑦ DIMENSION IS THE LENGTH OF LEAD FOR SOLDERING TO A SUBSTRATE.

FOOTPRINT

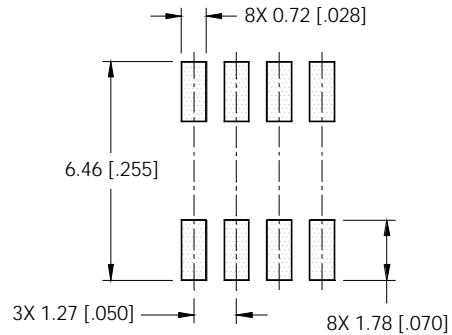

**SO-8 (Fetky) Part Marking Information**

EXAMPLE: THIS IS AN IRF7807D1 (FETKY)

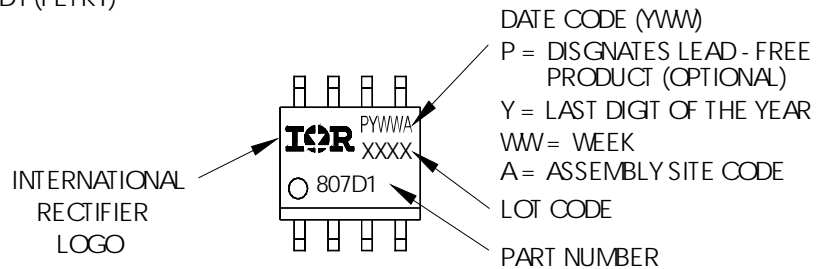

# IRF7324D1PbF

International  
**IR** Rectifier

## SO-8 (Fetky) Tape and Reel

Dimensions are shown in millimeters (inches)

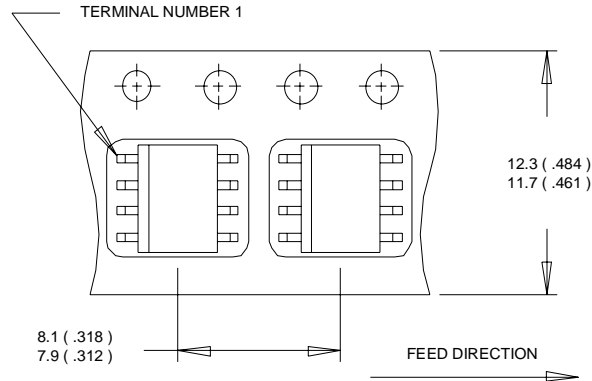

- NOTES:
1. CONTROLLING DIMENSION : MILLIMETER.
  2. ALL DIMENSIONS ARE SHOWN IN MILLIMETERS(INCHES).
  3. OUTLINE CONFORMS TO EIA-481 & EIA-541.

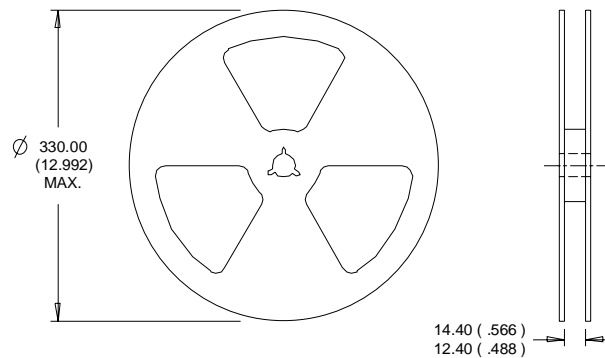

- NOTES :
1. CONTROLLING DIMENSION : MILLIMETER.
  2. OUTLINE CONFORMS TO EIA-481 & EIA-541.

### Notes:

- ① Repetitive rating; pulse width limited by maximum junction temperature (see figure 11)
- ②  $I_{SD} \leq -2.2A$ ,  $di/dt \leq -96A/\mu s$ ,  $V_{DD} \leq V_{(BR)DSS}$ ,  $T_J \leq 150^\circ C$
- ③ Pulse width  $\leq 300\mu s$ ; duty cycle  $\leq 2\%$
- ④ Surface mounted on FR-4 board, steady-state
- ⑤  $R_{\theta}$  is measured at  $T_J$  of approximately  $90^\circ C$ .

International  
**IR** Rectifier

IR WORLD HEADQUARTERS: 233 Kansas St., El Segundo, California 90245, USA Tel: (310) 252-7105

TAC Fax: (310) 252-7903

Visit us at [www.irf.com](http://www.irf.com) for sales contact information. 12/04

[www.irf.com](http://www.irf.com)