

Thermally-Enhanced High Power RF LDMOS FET 70 W, 2110 – 2170 MHz

Description

The PTFA210701E and PTFA210701F are 70-watt LDMOS FETs designed for single- and dual-carrier WCDMA power amplifier applications in the 2110 MHz to 2170 MHz band. Features include input and output matching, and thermally-enhanced packages with slotted or earless flanges. Manufactured with Infineon's advanced LDMOS process, these devices provide excellent thermal performance and superior reliability.

PTFA210701E
Package H-36265-2

PTFA210701F
Package H-37265-2

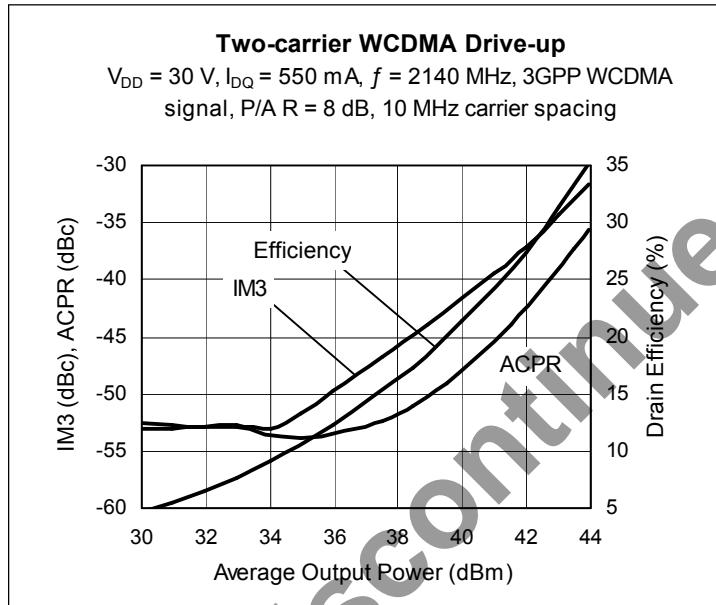
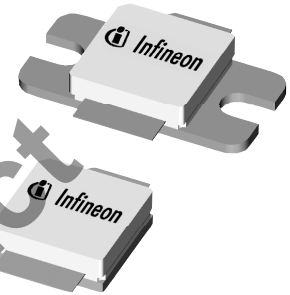

Features

- Thermally-enhanced packages, Pb-free and RoHS-compliant
- Broadband internal matching
- Typical two-carrier WCDMA performance at 2140 MHz, 30 V
 - Average output power = 42 dBm
 - Linear Gain = 16.5 dB
 - Efficiency = 27.0%
 - Intermodulation distortion = -37 dBc
 - Adjacent channel power = -42.5 dBc
- Typical CW performance, 2170 MHz, 30 V
 - Output power at P-1dB = 80 W
 - Efficiency = 58%
- Integrated ESD protection: Human Body Model, Class 2 (minimum)
- Excellent thermal stability, low HCI drift
- Capable of handling 10:1 VSWR @ 30 V, 70 W (CW) output power

RF Characteristics

WCDMA Measurements (tested in Infineon test fixture)

$V_{DD} = 30\text{ V}$, $I_{DQ} = 550\text{ mA}$, $P_{OUT} = 18\text{ W}$ average

$f_1 = 2135\text{ MHz}$, $f_2 = 2145\text{ MHz}$, 3GPP signal, channel bandwidth = 3.84 MHz, peak/average = 8 dB @ 0.01% CCDF

Characteristic	Symbol	Min	Typ	Max	Unit
Gain	G_{ps}	15.5	16.5	—	dB
Drain Efficiency	η_D	28	29	—	%
Intermodulation Distortion	IMD	—	-36.5	-35.5	dBc

All published data at $T_{CASE} = 25^\circ\text{C}$ unless otherwise indicated

ESD: Electrostatic discharge sensitive device—observe handling precautions!

RF Characteristics (cont.)

Two-tone Measurements (not subject to production test—verified by design/characterization in Infineon test fixture)

$V_{DD} = 30\text{ V}$, $I_{DQ} = 550\text{ mA}$, $P_{OUT} = 70\text{ W PEP}$, $f = 2140\text{ MHz}$, tone spacing = 1 MHz

Characteristic	Symbol	Min	Typ	Max	Unit
Gain	G_{ps}	—	16.5	—	dB
Drain Efficiency	η_D	—	41	—	%
Intermodulation Distortion	IMD	—	-29.5	—	dBc

DC Characteristics

Characteristic	Conditions	Symbol	Min	Typ	Max	Unit
Drain-Source Breakdown Voltage	$V_{GS} = 0\text{ V}$, $I_{DS} = 10\text{ mA}$	$V_{(BR)DSS}$	65	—	—	V
Drain Leakage Current	$V_{DS} = 28\text{ V}$, $V_{GS} = 0\text{ V}$	I_{DSS}	—	—	1.0	μA
	$V_{DS} = 63\text{ V}$, $V_{GS} = 0\text{ V}$	I_{DSS}	—	—	10.0	μA
On-State Resistance	$V_{GS} = 10\text{ V}$, $V_{DS} = 0.1\text{ V}$	$R_{DS(on)}$	—	0.125	—	Ω
Operating Gate Voltage	$V_{DS} = 30\text{ V}$, $I_{DQ} = 550\text{ mA}$	V_{GS}	2.0	2.5	3.0	V
Gate Leakage Current	$V_{GS} = 10\text{ V}$, $V_{DS} = 0\text{ V}$	I_{GSS}	—	—	1.0	μA

Maximum Ratings

Parameter	Symbol	Value	Unit
Drain-Source Voltage	V_{DSS}	65	V
Gate-Source Voltage	V_{GS}	-0.5 to +12	V
Junction Temperature	T_J	200	$^{\circ}\text{C}$
Total Device Dissipation	P_D	190	W
		Above 25 $^{\circ}\text{C}$ derate by	1.09
Storage Temperature Range	T_{STG}	-40 to +150	$^{\circ}\text{C}$
Thermal Resistance ($T_{CASE} = 70^{\circ}\text{C}$, 70 W CW)	$R_{\theta JC}$	0.92	$^{\circ}\text{C}/\text{W}$

Ordering Information

Type and Version	Package Type	Package Description	Marking
PTFA210701E V4	H-36265-2	Thermally-enhanced slotted flange, single-ended	PTFA210701E
PTFA210701F V4	H-37265-2	Thermally-enhanced earless flange, single-ended	PTFA210701F

Typical Performance (data taken in a production test fixture)

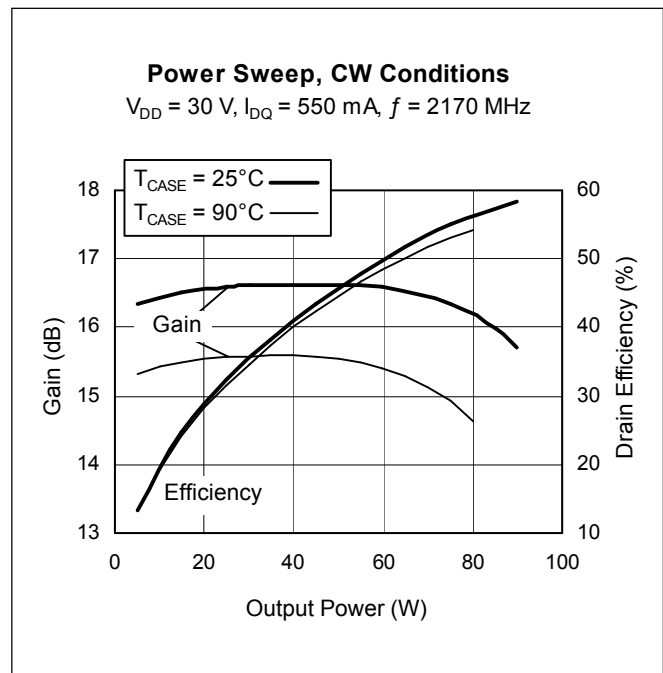
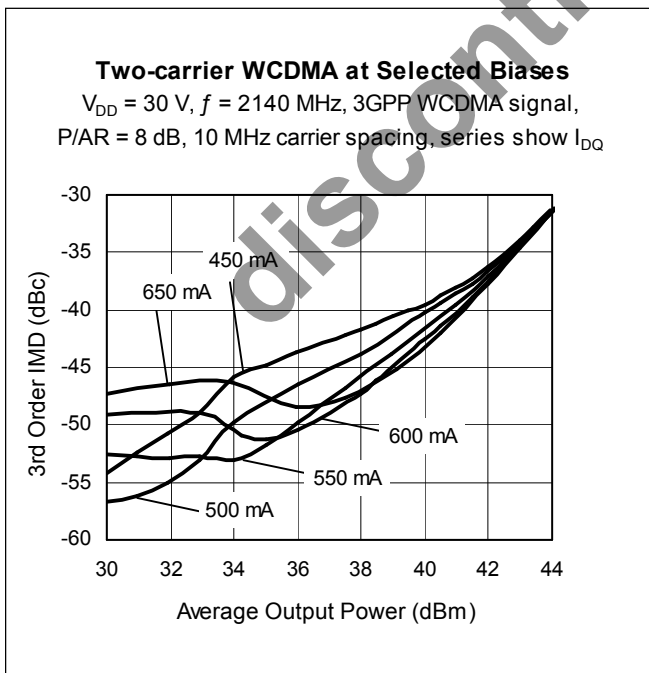
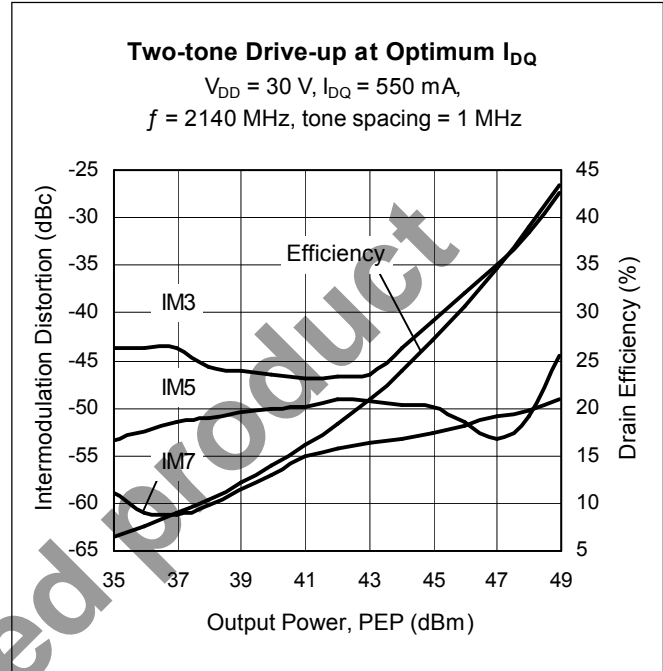
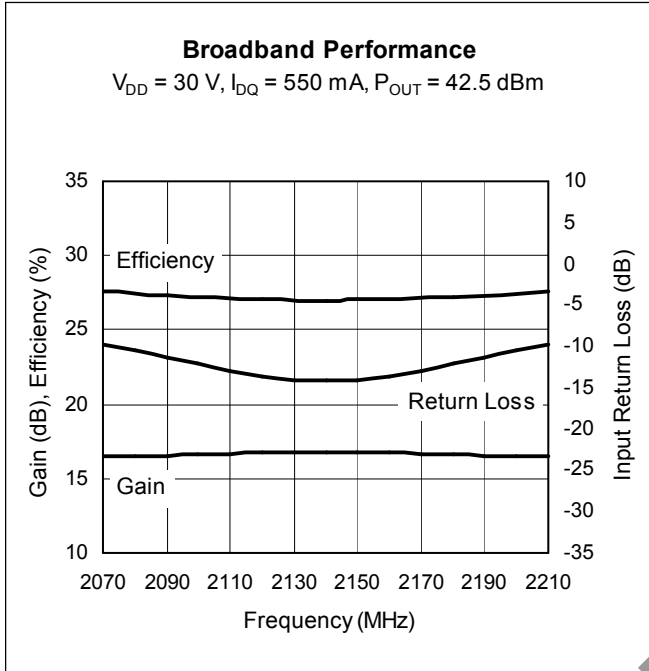

Typical Performance (cont.)

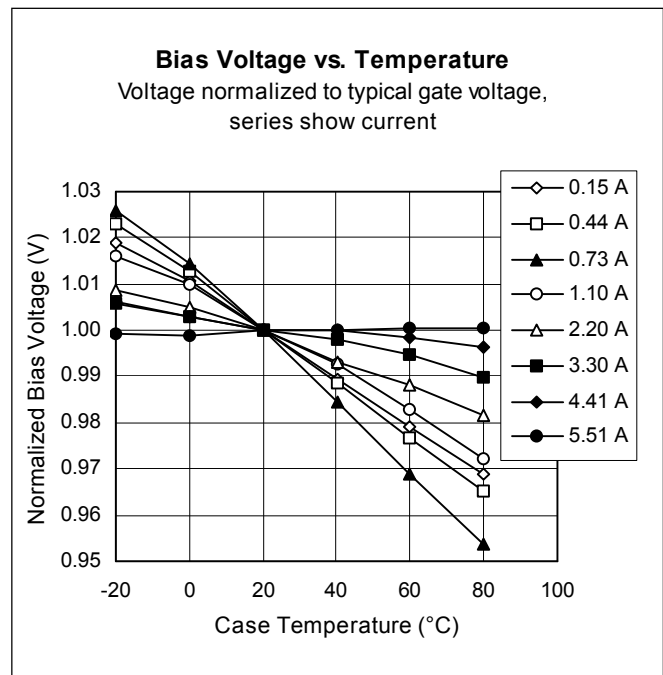
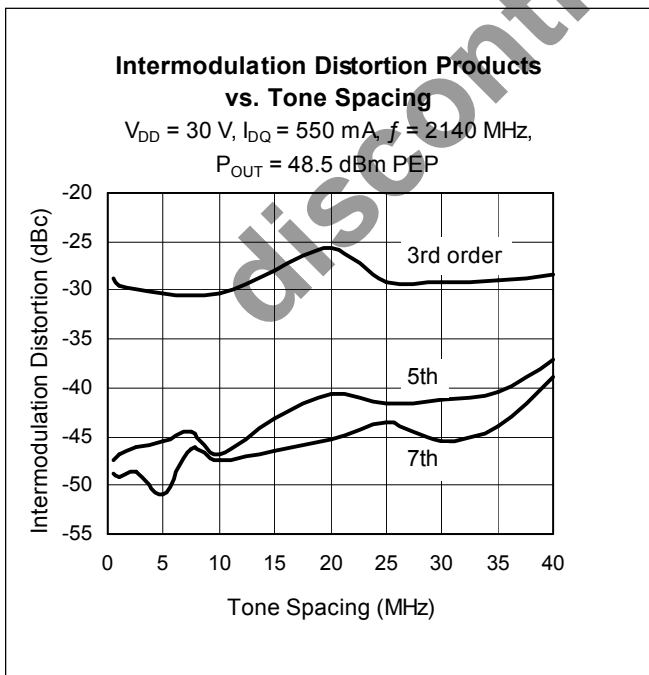
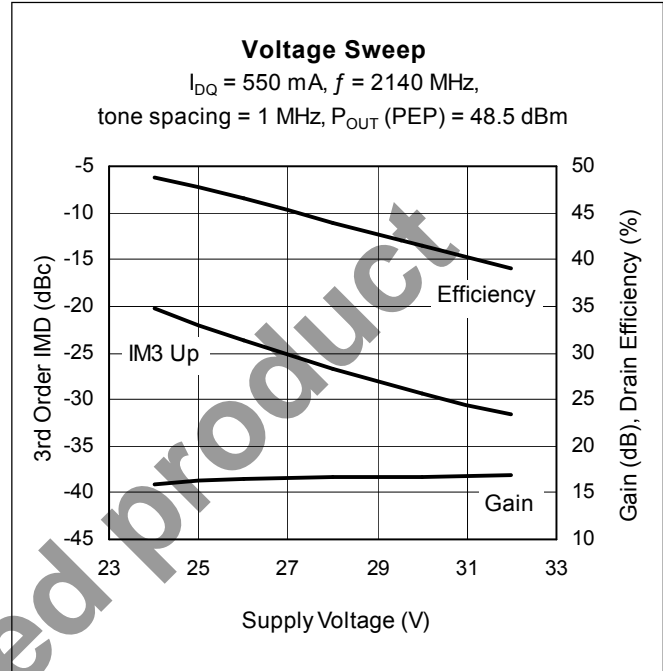
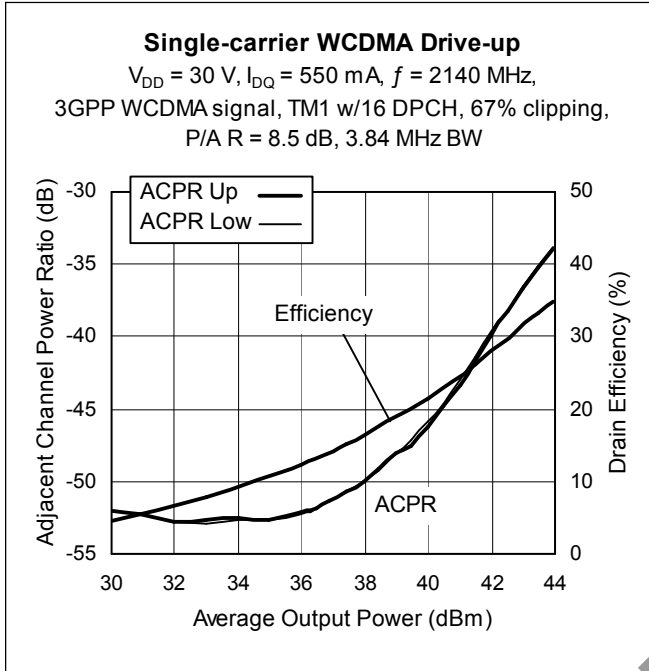

Broadband Circuit Impedance

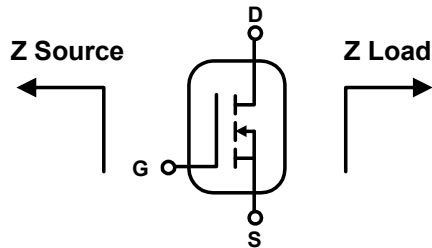

Frequency MHz	Z Source W		Z Load W	
	R	jX	R	jX
2060	19.94	1.61	4.50	-2.87
2110	20.94	0.77	4.20	-2.50
2140	21.41	0.11	4.02	-2.29
2170	21.83	-0.69	3.88	-2.07
2220	22.26	-2.09	3.66	-1.66

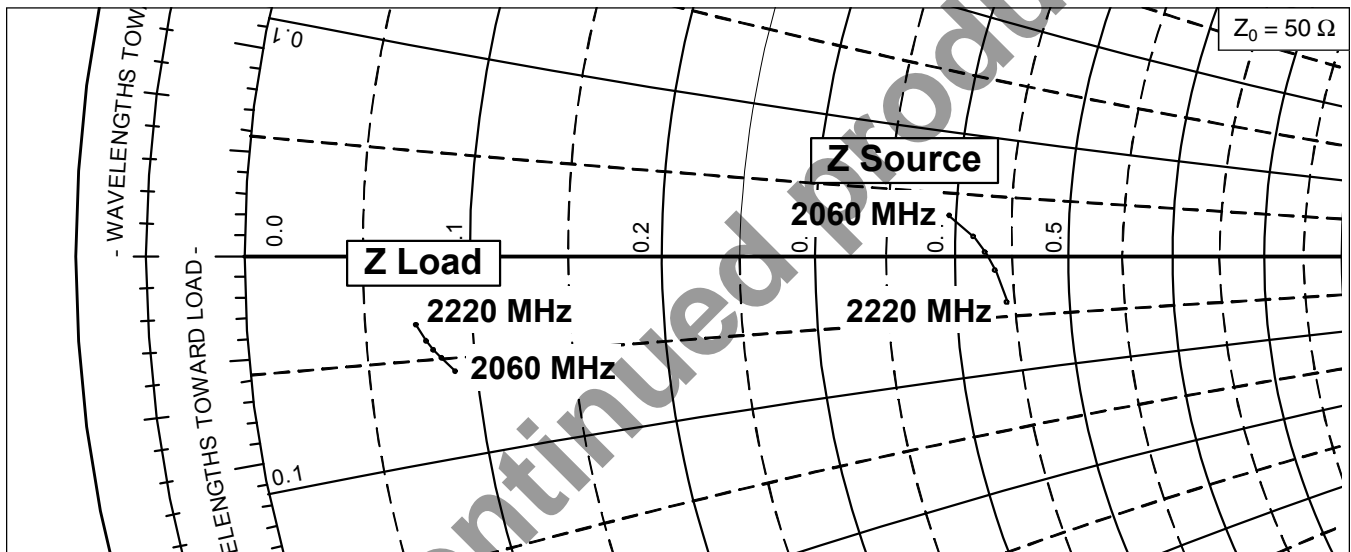

See next page for circuit information

Reference Circuit

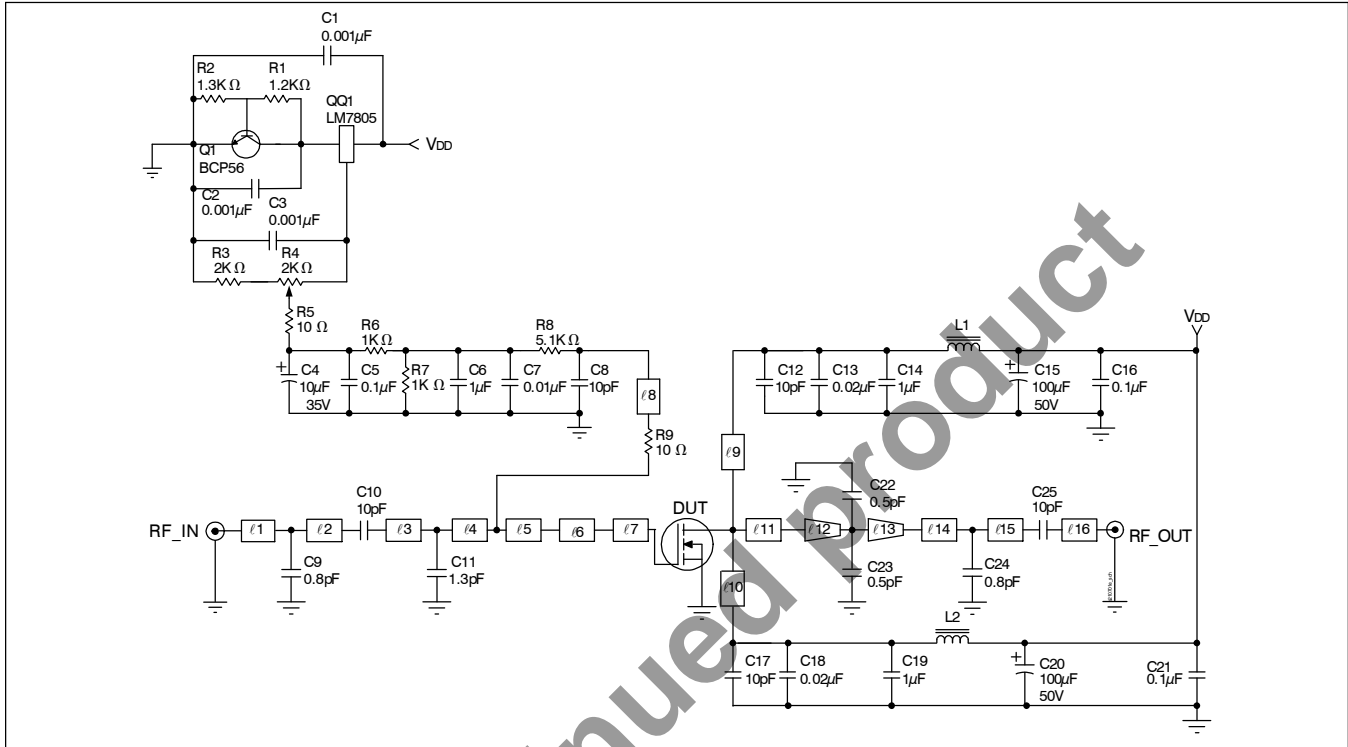

Reference circuit schematic for $f = 2140 \text{ MHz}$

Circuit Assembly Information

DUT	PTFA210701E or PTFA210701F	LDMOS Transistor	
PCB	0.76 mm [.030"] thick, $\epsilon_r = 3.48$	Rogers 4350	1 oz. copper

Microstrip	Electrical Characteristics at 2140 MHz ¹	Dimensions: L x W (mm)	Dimensions: L x W (in.)
l1	0.112 λ , 50.0 Ω	9.53 x 1.78	0.375 x 0.070
l2	0.053 λ , 50.0 Ω	4.52 x 1.78	0.178 x 0.070
l3	0.044 λ , 43.0 Ω	3.73 x 2.18	0.147 x 0.086
l4	0.054 λ , 43.0 Ω	4.57 x 2.18	0.180 x 0.086
l5	0.016 λ , 43.0 Ω	1.37 x 2.18	0.054 x 0.086
l6	0.022 λ , 14.6 Ω	1.73 x 8.76	0.068 x 0.345
l7	0.062 λ , 12.2 Ω	4.88 x 10.82	0.192 x 0.426
l8	0.214 λ , 61.0 Ω	18.36 x 1.22	0.723 x 0.048
l9, l10	0.211 λ , 53.0 Ω	17.91 x 1.57	0.705 x 0.062
l11	0.042 λ , 6.5 Ω	3.25 x 21.84	0.128 x 0.860
l12 (taper)	0.043 λ , 6.5 Ω / 16.2 Ω	3.30 x 21.84 / 7.80	0.130 x 0.860 / 0.307
l13 (taper)	0.023 λ , 16.2 Ω / 50.0 Ω	1.88 x 7.80 / 1.57	0.074 x 0.307 / 0.062
l14	0.010 λ , 53.0 Ω	0.89 x 1.57	0.035 x 0.062
l15	0.130 λ , 53.0 Ω	11.07 x 1.57	0.436 x 0.062
l16	0.116 λ , 53.0 Ω	9.88 x 1.57	0.389 x 0.062

¹Electrical characteristics are rounded.

Reference Circuit (cont.)

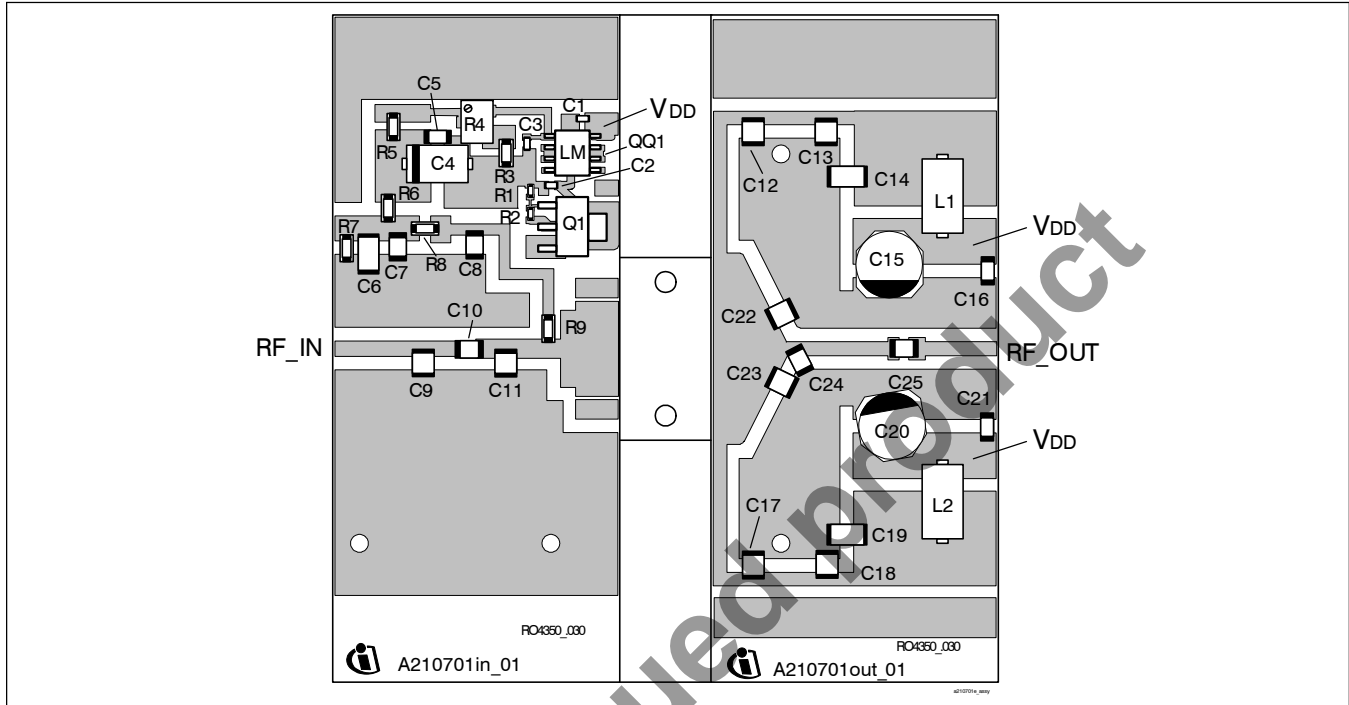

Reference circuit assembly diagram (not to scale)*

Component	Description	Suggested Manufacturer	P/N or Comment
C1, C2, C3	Capacitor, 0.001 μ F	Digi-Key	PCC1772CT-ND
C4	Tantalum capacitor, 10 μ F, 35 V	Digi-Key	399-1655-2-ND
C5, C16, C21	Capacitor, 0.1 μ F	Digi-Key	PCC104BCT-ND
C6, C14, C19	Ceramic capacitor, 1 μ F	Digi-Key	445-1411-2-ND
C7	Capacitor, 0.01 μ F	ATC	200B 103
C8, C10, C12, C17, C25	Ceramic capacitor, 10 pF	ATC	100B 100
C9, C24	Ceramic capacitor, 0.8 pF	ATC	100B 0R8
C11	Ceramic capacitor, 1.3 pF	ATC	100B 1R3
C13, C18	Capacitor, 0.02 μ F	ATC	200B 203
C15, C20	Electrolytic capacitor, 100 μ F, 50 V	Digi-Key	PCE3718CT-ND
C22, C23	Ceramic capacitor, 0.5pF	ATC	100B 0R5
L1, L2	Ferrite, 8.9 mm	Elna Magnetics	BDS 4.6/3/8.9-4S2
Q1	Transistor	Infineon Technologies	BCP56
QQ1	Voltage regulator	National Semiconductor	LM7805
R1	Chip resistor 1.2K ohms	Digi-Key	P1.2KGCT-ND
R2	Chip resistor 1.3K ohms	Digi-Key	P1.3KGCT-ND
R3	Chip resistor 2K ohms	Digi-Key	P2KECT-ND
R4	Potentiometer 2K ohms	Digi-Key	3224W-202ETR-ND
R5, R9	Chip resistor 10 ohms	Digi-Key	P10ECT-ND
R6, R7	Chip resistor 1K ohms	Digi-Key	P1KECT-ND
R8	Chip resistor 5.1K ohms	Digi-Key	P5.1KECT-ND

*Gerber Files for this circuit available on request

Package Outline Specifications

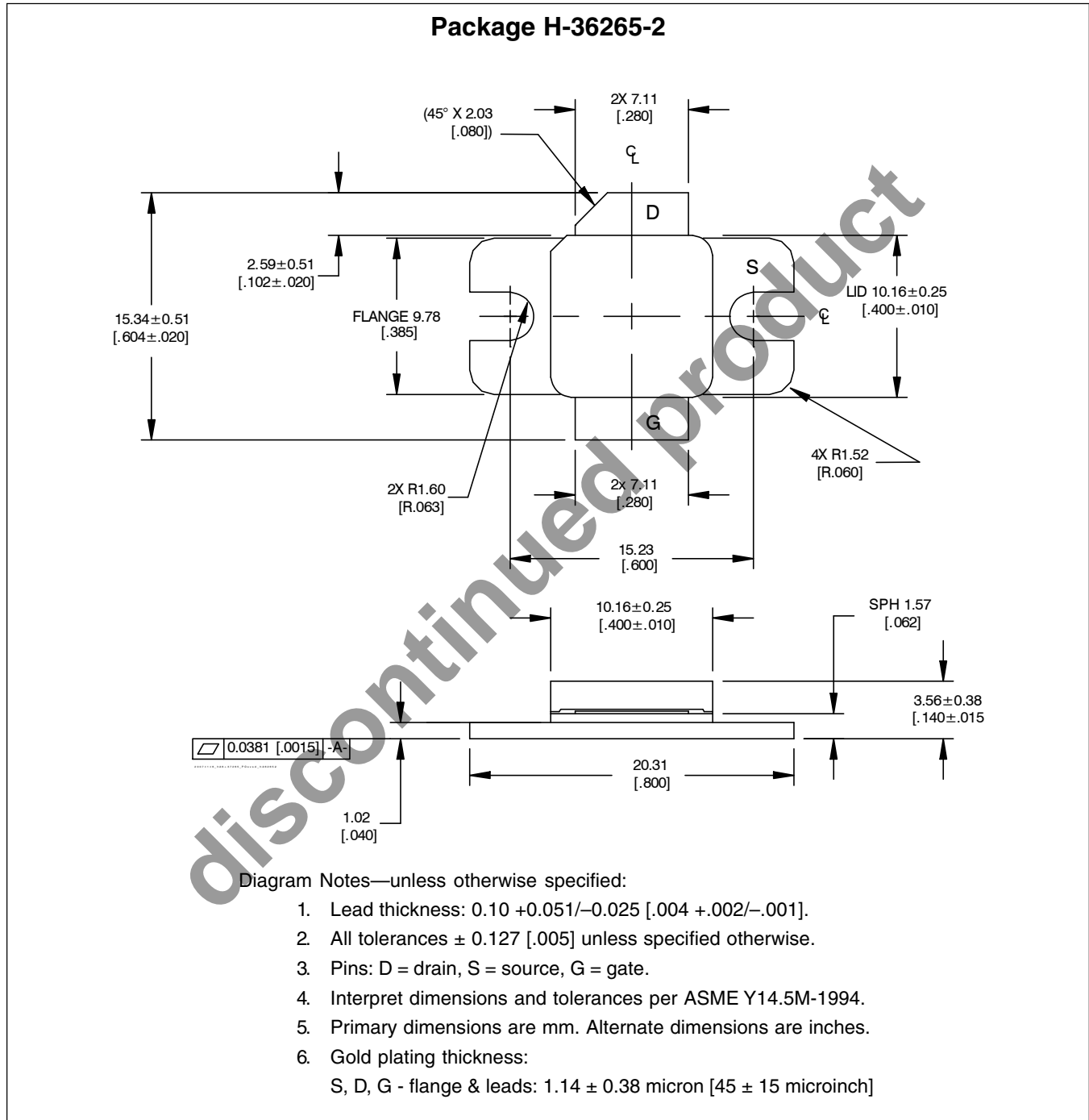

Find the latest and most complete information about products and packaging at the Infineon Internet page
<http://www.infineon.com/products>

Package Outline Specifications (cont.)

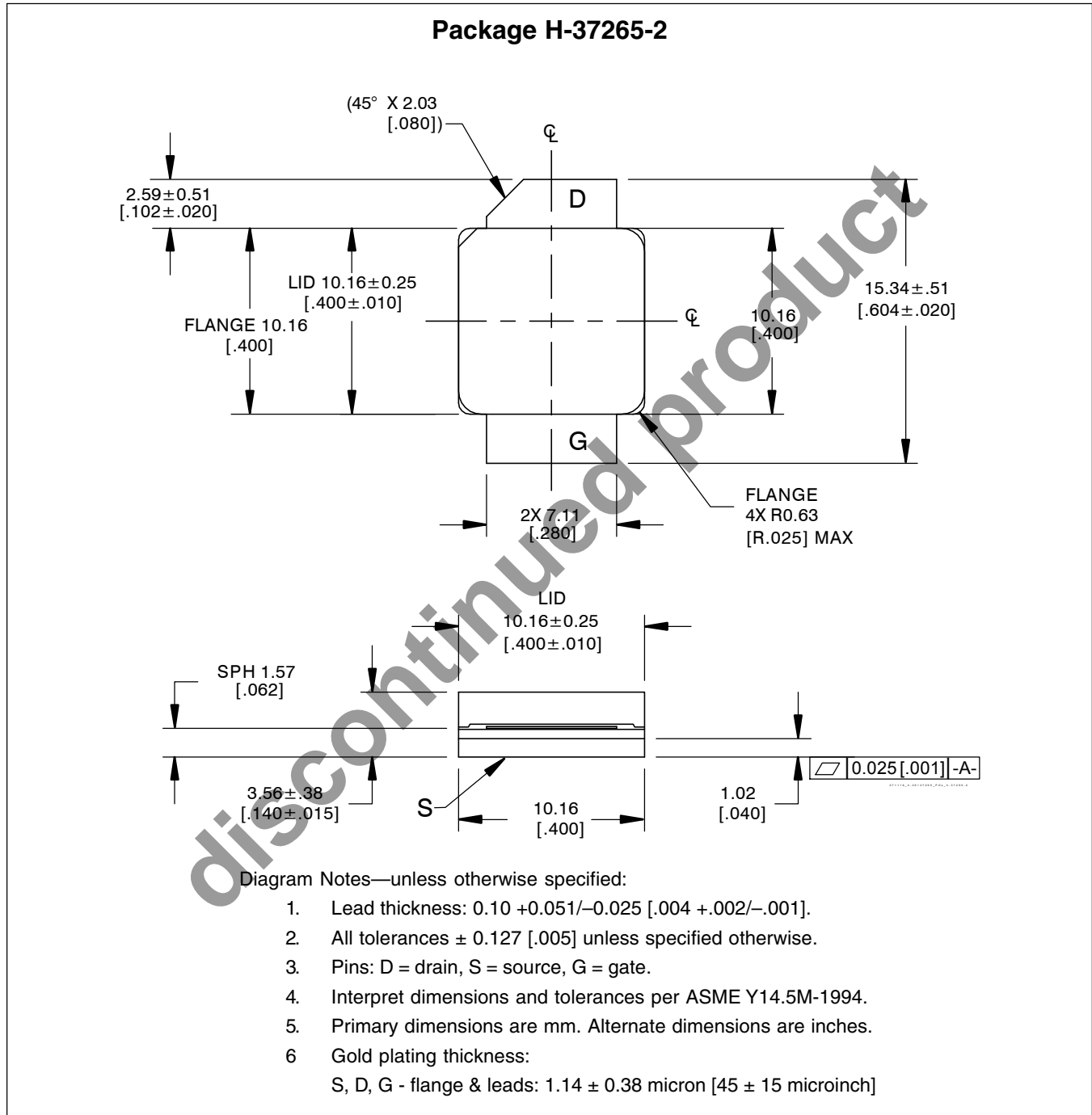

Find the latest and most complete information about products and packaging at the Infineon Internet page
<http://www.infineon.com/products>

Revision History:	2014-02-12	Data Sheet
Previous Version:	2009-02-18 , Data Sheet	
Page	Subjects (major changes since last revision)	
All	Product Discontinued. Please see PD Notes: PD_012_14	

We Listen to Your Comments

Any information within this document that you feel is wrong, unclear or missing at all?
Your feedback will help us to continuously improve the quality of this document.
Please send your proposal (including a reference to this document) to:

highpowerRF@infineon.com

To request other information, contact us at:
+1 877 465 3667 (1-877-GO-LDMOS) USA
or +1 408 776 0600 International

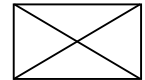

Edition 2014-02-12

Published by
Infineon Technologies AG
85579 Neubiberg, Germany

© 2014 Infineon Technologies AG
All Rights Reserved.

Legal Disclaimer

The information given in this document shall in no event be regarded as a guarantee of conditions or characteristics. With respect to any examples or hints given herein, any typical values stated herein and/or any information regarding the application of the device, Infineon Technologies hereby disclaims any and all warranties and liabilities of any kind, including without limitation, warranties of non-infringement of intellectual property rights of any third party.

Information

For further information on technology, delivery terms and conditions and prices, please contact the nearest Infineon Technologies Office (www.infineon.com/rfpower).

Warnings

Due to technical requirements, components may contain dangerous substances. For information on the types in question, please contact the nearest Infineon Technologies Office.

Infineon Technologies components may be used in life-support devices or systems only with the express written approval of Infineon Technologies, if a failure of such components can reasonably be expected to cause the failure of that life-support device or system or to affect the safety or effectiveness of that device or system. Life support devices or systems are intended to be implanted in the human body or to support and/or maintain and sustain and/or protect human life. If they fail, it is reasonable to assume that the health of the user or other persons may be endangered.