

General purpose amplification (–30V, –1A)

2SB1710

●Application

Low frequency amplifier
Driver

●Features

- 1) A collector current is large.
- 2) Collector saturation voltage is low.
 $V_{CE(sat)} \leq -350\text{mV}$
 at $I_C = -500\text{mA} / I_B = -25\text{mA}$

●External dimensions (Units : mm)

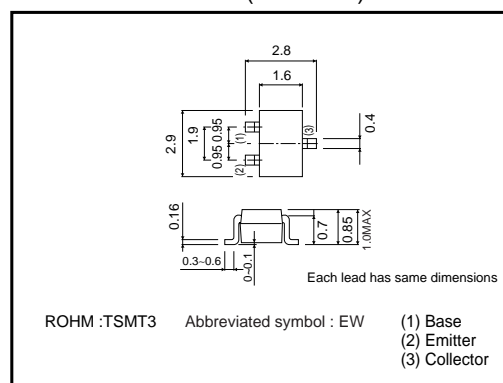

●Absolute maximum ratings (Ta=25°C)

Parameter	Symbol	Limits	Unit
Collector-base voltage	V_{CBO}	–30	V
Collector-emitter voltage	V_{CEO}	–30	V
Emitter-base voltage	V_{EBO}	–6	V
Collector current	I_C	–1	A
	I_{CP}	–2	A*1
Power dissipation	P_C	500	mW*2
Junction temperature	T_j	150	°C
Range of storage temperature	T_{stg}	–55~+150	°C

*1Single pulse, $P_W=1\text{ms}$

*2Each Terminal Mounted on a Recommended

●Packaging specifications

Type	Package	Taping
	Code	TL
	Basic ordering unit (pieces)	3000
2SB1710		○

●Electrical characteristics (Ta=25°C)

Parameter	Symbol	Min.	Typ.	Max.	Unit	Conditions
Collector-base breakdown voltage	BV_{CBO}	–30	–	–	V	$I_C = -10\mu\text{A}$
Collector-emitter breakdown voltage	BV_{CEO}	–30	–	–	V	$I_C = -1\text{mA}$
Emitter-base breakdown voltage	BV_{EBO}	–6	–	–	V	$I_E = -10\mu\text{A}$
Collector cutoff current	I_{CBO}	–	–	–100	nA	$V_{CB} = -30\text{V}$
Emitter cutoff current	I_{EBO}	–	–	–100	nA	$V_{EB} = -6\text{V}$
Collector-emitter saturation voltage	$V_{CE(sat)}$	–	–150	–350	mV	$I_C = -500\text{mA}, I_B = -25\text{mA}$
DC current gain	h_{FE}	270	–	680	–	$V_{CE} = -2\text{V}, I_C = -100\text{mA}$ *
Transition frequency	f_T	–	320	–	MHz	$V_{CE} = -2\text{V}, I_E = 100\text{mA}, f = 100\text{MHz}$ *
Collector output capacitance	C_{ob}	–	7	–	pF	$V_{CB} = -10\text{V}, I_E = 0\text{A}, f = 1\text{MHz}$

* Pulsed

Transistors

●Electrical characteristic curves

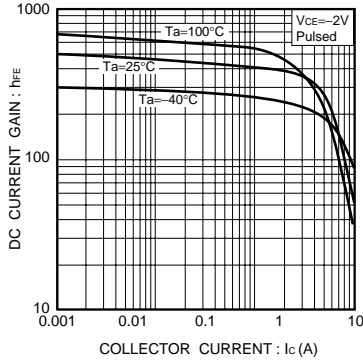

Fig.1 DC current gain vs. collector current

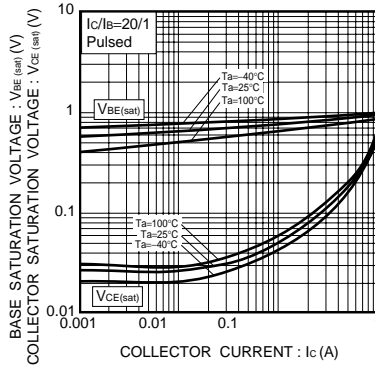

Fig.2 Collector-emitter saturation voltage base-emitter saturation voltage vs. collector current

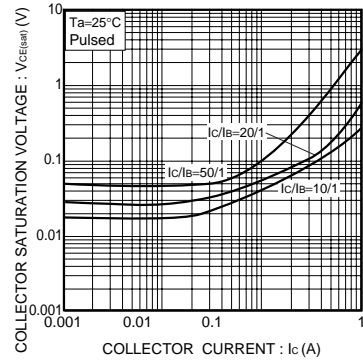

Fig.3 Collector-emitter saturation voltage vs. collector current

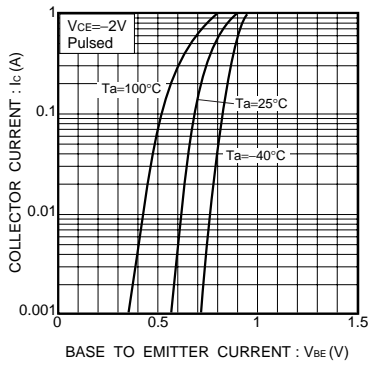

Fig.4 Grounded emitter propagation characteristics

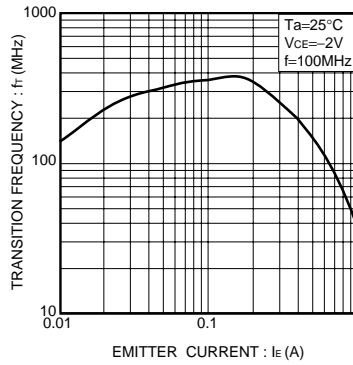

Fig.5 Gain bandwidth product vs. emitter current

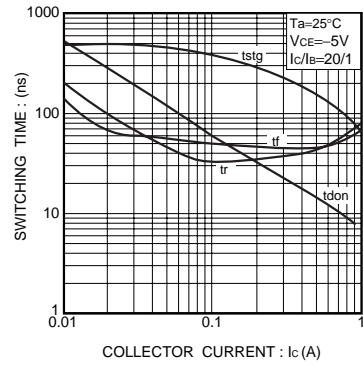

Fig.6 Switching time

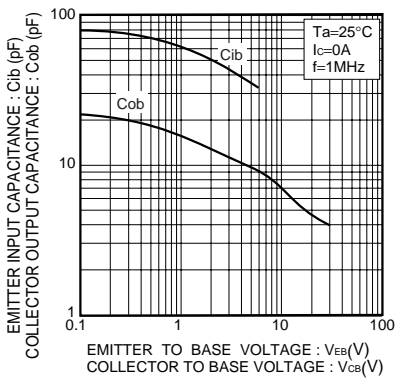

Fig.7 Collector output capacitance vs. collector-base voltage
Emitter input capacitance vs. emitter-base voltage