

TYPICAL SWITCH ORDERING EXAMPLE

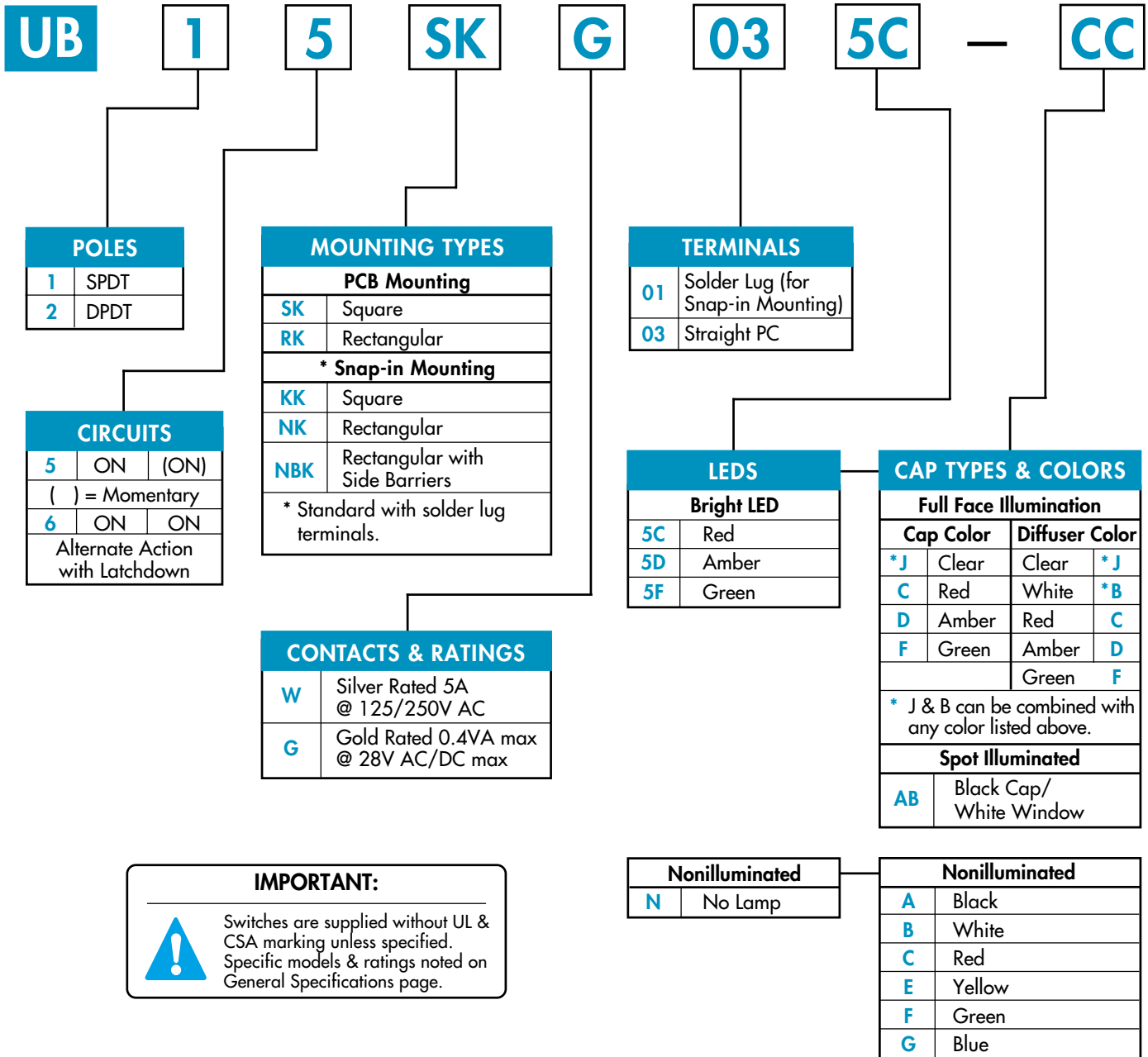

DESCRIPTION FOR TYPICAL ORDERING EXAMPLE

UB15SKG035C-CC

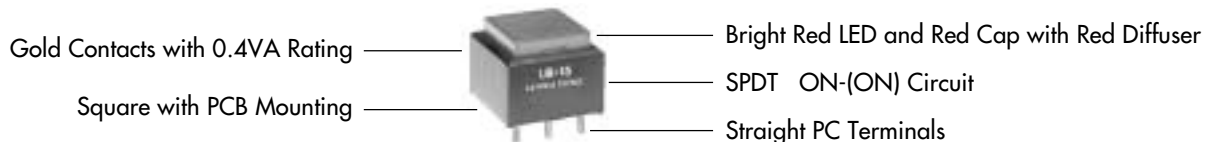

GENERAL SPECIFICATIONS

Electrical Capacity (Resistive Load)

Power Level (code W): 5A @ 125/250V AC or 5A @ 30V DC
Logic Level (code G): 0.4VA maximum @ 28V AC/DC maximum
 Note: See Supplement Index (page Z1) to find explanation of operating range.

Other Ratings

Contact Resistance: 50 milliohms maximum for silver; 100 milliohms maximum for gold
Insulation Resistance: 200 megohms minimum @ 500V DC
Dielectric Strength: 1,000V AC minimum between contacts;
 1,500V AC minimum between contacts & case
Mechanical Life: 1,000,000 operations minimum for momentary;
 200,000 operations minimum for alternate action
Electrical Life: 10,000 operations minimum for silver;
 100,000 operations minimum for silver with resistive load of 3A @ 125V AC
 200,000 operations minimum for gold
Nominal Operating Force: Single Pole: 160 grams for Square & 194 grams for Rectangular
 Double Pole: 260 grams for Square & 316 grams for Rectangular
Contact Timing: Break before make
Travel: Square: 1.7mm (.067") pretravel; 0.6mm (.024") overtravel; 2.3mm (.091") total
 Rectangular: 1.7mm (.067") pretravel; 0.7mm (.028") overtravel; 2.4mm (.095") total

Materials & Finishes

Housing/Bezel: Glass fiber reinforced polyamide
Snap-in Frame: Stainless steel
Movable Contactor: Phosphor bronze
Movable Contacts: Silver alloy or copper with gold plating over nickel
Stationary Contacts: Silver alloy or copper with gold plating over nickel
Switch Terminals: Phosphor bronze with silver or gold plating
Lamp Terminals: Brass with silver plating
Base: Glass fiber reinforced liquid crystal polymer

Environmental Data

Operating Temp Range: Illuminated: -25°C through +50°C (-13°F through +122°F)
 Nonilluminated: -20°C through +70°C (-4°F through +158°F)
Humidity: 90 ~ 95% humidity for 96 hours @ 40°C (104°F)
Vibration: 10 ~ 55Hz with peak-to-peak amplitude of 1.5mm traversing the frequency range
 & returning in 1 minute; 3 right angled directions for 2 hours
Shock: 50g acceleration (tested in 6 right angled directions, with 5 shocks in each direction)

Installation

Cap Installation Force: .77 kg (1.69 lb)
Soldering Time & Temperature: 3 seconds @ 350°C or 5 seconds @ 270°C
Process Seal: Not available

Standards & Certifications

Flammability Standards: UL94V-0 housing/bezel of GFR polyamide & base of GFR liquid crystal polymer
UL Recognized: All single & double pole models recognized at 5A @ 125/250V AC or
 0.014A @ 28V DC; UL File No. E44145
CSA Certified: All single & double pole models certified at 5A @ 125/250V AC or 5A @ 30V DC or
 0.4VA maximum @ 28V AC/DC maximum; CSA File Nos. LR23535

POLES & CIRCUITS

		Plunger Position () = Momentary		Connected Terminals		Throw & Power/Lamp Schematics
Pole	Model	Normal	Down	Normal	Down	
SP	UB15 UB16*	ON ON	(ON) ON	1-3	1-2	Notes: Switch is marked with NC, NO, COM, L+ & L-. Lamp circuit is isolated and requires external power source.
DP	UB25 UB26*	ON ON	(ON) ON	1-3 4-6	1-2 4-5	

* When in latched position for the alternate circuit, cap position is 1.0mm (.039") above the housing.

SHAPES & MOUNTING TYPES

PCB Mounting

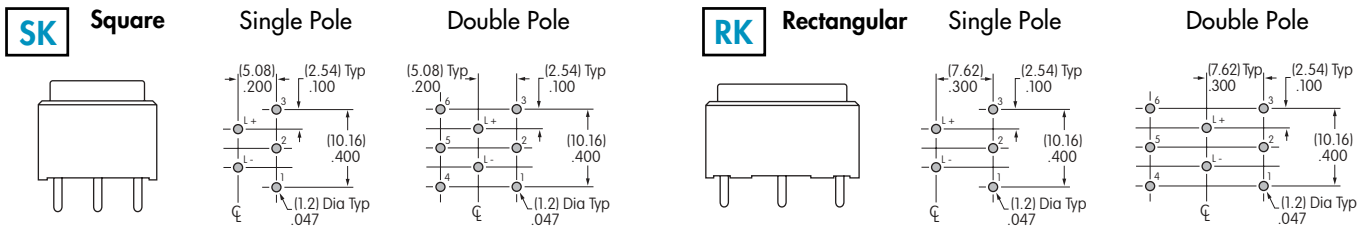

Nonilluminated models have no lamp terminals.

Snap-In Mounting

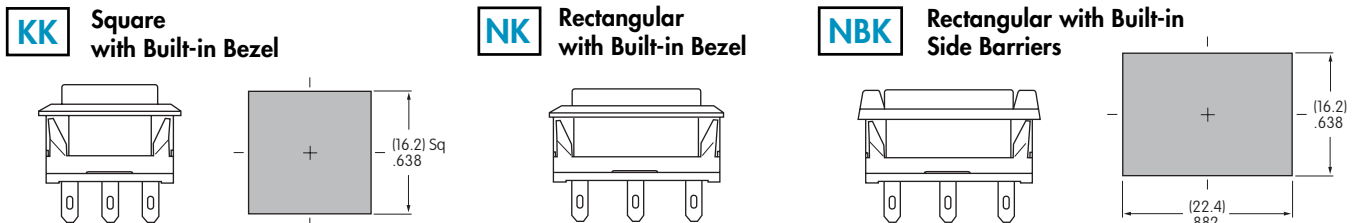

Snap-in Mounting with Solder Lug terminals is the standard combination. Panel Thickness: 1.0 ~ 3.2mm (.039 ~ 1.26")

CONTACT MATERIALS & RATINGS



Silver Contacts

Power Level

5A @ 125V AC & 250V AC



Gold Contacts

Logic Level

0.4VA maximum @ 28V AC/DC maximum

See Supplement Index (page Z1) for complete explanation of operating range.

TERMINALS



Solder Lug

The .032" x .063" oblong hole accommodates two solid or stranded 24-gauge wires.

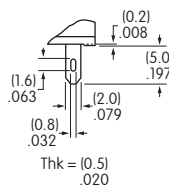

Straight PC

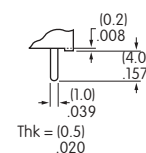

LED COLORS & SPECIFICATIONS

Electrical specifications are determined at a basic temperature of 25°C.
LED circuit is independent of switch operation. If the source voltage is greater than rated voltage, a ballast resistor is required.
The ballast resistor calculation and more lamp detail are shown in the Supplement; see Supplement Index (page Z1).

Bright LED

LEDs are an integral part of the switch and not available separately.	(+)-O  -O(-)		5C	5D	5F	Unit
	Color		Red	Amber	Green	
	Forward Peak Current	I_{FM}	30	30	25	mA
	Continuous Forward Current	I_F	20	20	20	mA
	Forward Voltage	V_F	1.85	2.0	2.25	V
	Reverse Peak Voltage	V_{RM}	5	5	5	V
Current Reduction Rate Above 25°C	ΔI_F	0.40	0.42	0.46	mA/°C	

N Code N indicates that no lamp is used.

CAP TYPES & COLOR COMBINATIONS

Transparent Cap with Diffuser for Full Face Illuminated

J

Clear

Caps
AT4074 Square

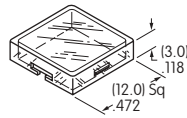

C

Red

D

Amber

AT4117 Rectangular

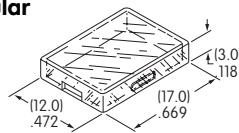

F

Green

J

Clear (for square only)

B

White

C

Red

D

Amber

F

Green

Diffusers

AT4075 Diffuser
for AT4074 Square Cap



AT4118 Diffuser
for AT4117 Rectangular Cap

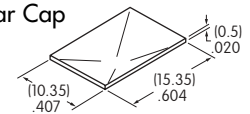

Cap & Diffuser Material: Polycarbonate Lens Finish: Glossy Diffuser Finish: Textured

Note: Both cap & diffuser colors must be selected. J & B can be combined with any color.

Spot Illuminated Cap

AB

AT4119
Square

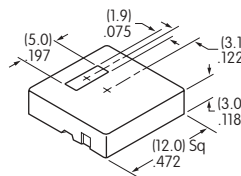

AT4120
Rectangular

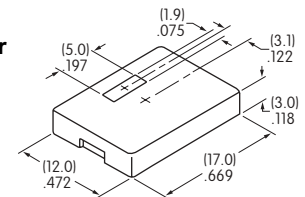

Material: Polycarbonate Finish: Matte

Opaque Cap for Nonilluminated

Colors Available:

A

Black

E

Yellow

B

White

F

Green

C

Red

G

Blue

AT4073
Square

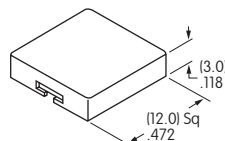

AT4116
Rectangular

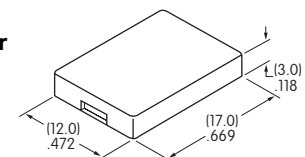

Material: Polycarbonate Finish: Glossy

TYPICAL SWITCH DIMENSIONS

Square • PCB Mount

Single & Double Pole

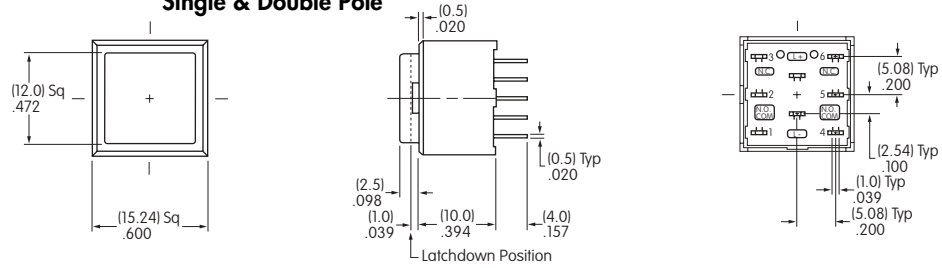

UB15SKG035C-CB

Single pole models do not have terminals 4, 5, & 6. Nonilluminated models do not have lamp terminals.

Rectangular • PCB Mount

Single & Double Pole

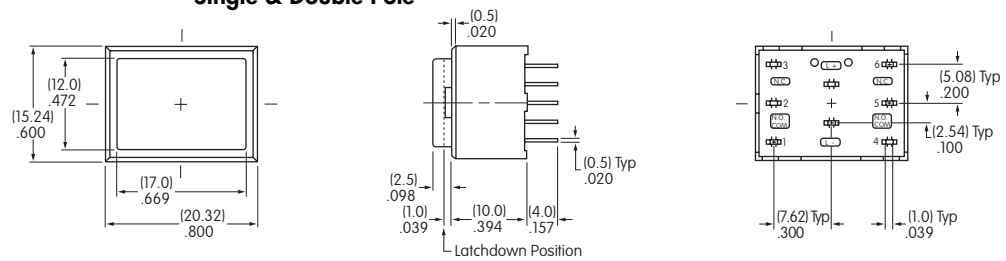

UB26RKG035D-DD

Single pole models do not have terminals 4, 5, & 6. Nonilluminated models do not have lamp terminals.

Square • Snap-in Mount • Built-in Bezel

Single & Double Pole

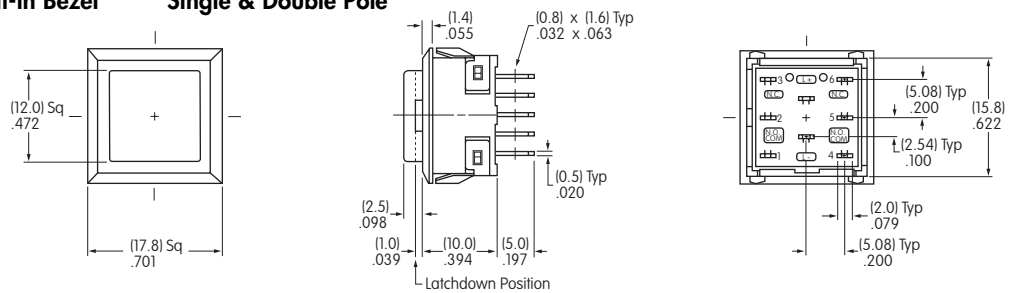

UB25KKW015C-CB

Single pole models do not have terminals 4, 5, & 6. Nonilluminated models do not have lamp terminals.

Rectangular • Snap-in Mount • Built-in Bezel

Single & Double Pole

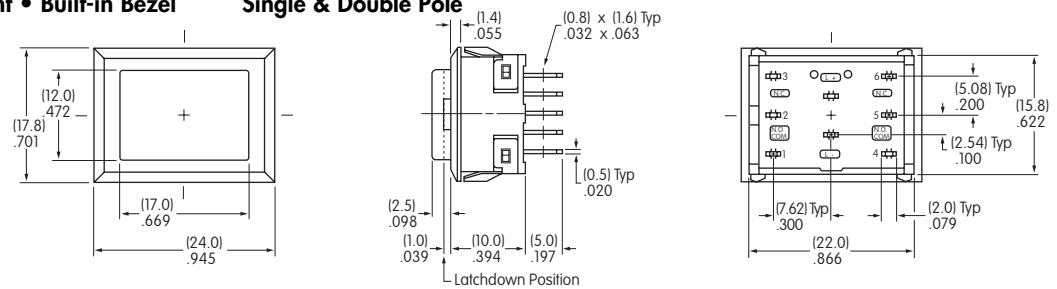

UB26NKG015F-DD

Single pole models do not have terminals 4, 5, & 6. Nonilluminated models do not have lamp terminals.

Rectangular • Snap-in Mount • Built-in Side Barriers

Single & Double Pole

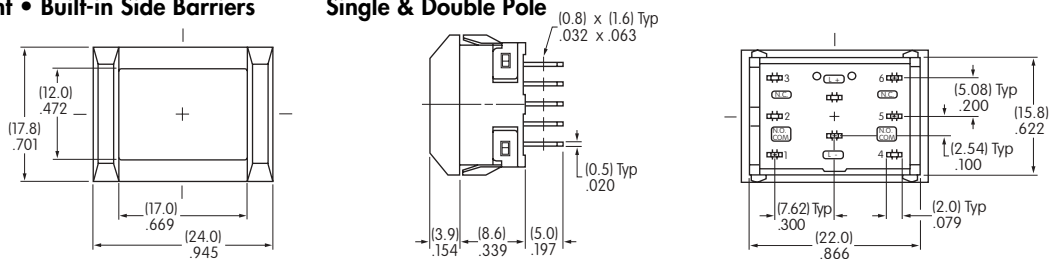

UB25NBKW015F-FB

Single pole models do not have terminals 4, 5, & 6. Nonilluminated models do not have lamp terminals.

OPTIONAL ACCESSORIES

Splash Covers

AT4001
Square

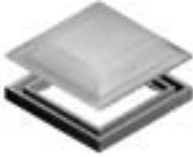

AT4011
Rectangular

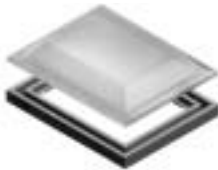

Not for use with barrier type models.

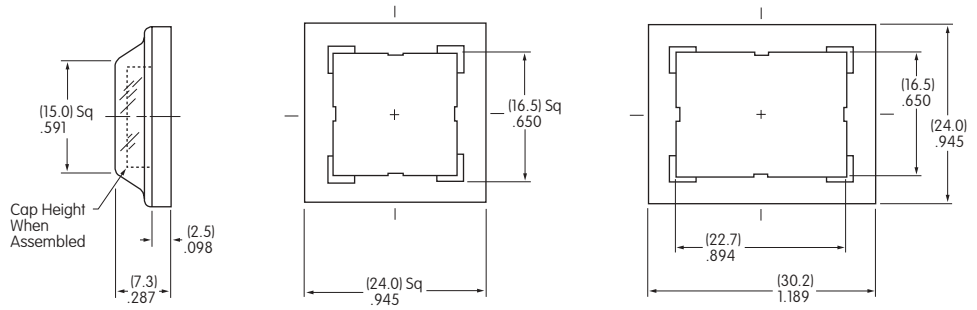

Materials:

PVC with polyethylene gasket

(PVC loses pliability below 0°C (32°F).)

Panel Thickness 1.0mm ~ 2.5mm (.039" ~ .098")